

DESCRIPTION

The Bluesocket 2020 Series Access Point (BSAP) provides cost effective, high performance, reliable coverage in wireless environments. These Access Points offer higher receive sensitivity on both the 2.4 GHz and 5 GHz radios to compensate for mobile devices that have a fraction of the transmit power of traditional laptops.

HARDWARE

The following items are included in your shipment:

- Bluesocket 2020 Series Access Point
- One plastic wall/ceiling mounting bracket with hardware (two metal screw anchors, two long screws, and two short screws)
- One flush/recessed ceiling T-rail mounting hardware kit (four T-rail clips [two sizes], two spacers, two long screws, and two short screws)

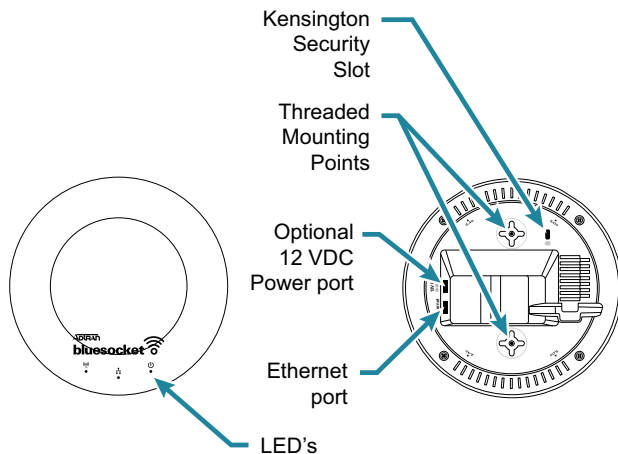

Figure 1. Bluesocket 2020 Series Access Point

Antennas

The BSAP provides one integrated, four element high-efficiency Planar Inverted F Antenna (PIFA) array with 3 dBi gain (no external antennas are required).

NOTE

Before mounting the BSAP to a wall or other surface, record the 12-character MAC address and serial number listed on the back of the unit. This information will be required during configuration.

Optional Equipment:

The following equipment is optional and can be purchased separately:

Description	P/N
External Power PoE Injector	1700923F1
External DC Power Adapter	1700928F1

INSTALLATION

Before installing the equipment, inspect the BSAP. If damage has occurred during shipping, file a claim with the carrier, and then contact ADTRAN Customer Support. For more information, refer to the warranty or to ADTRAN enhanced support for ProCare or ProCare NBD purchased upgrades.

Mounting the BSAP to a Ceiling or Wall

Position the BSAP for maximum throughput and range between other APs and wireless client devices. Follow these instructions to mount the BSAP to an interior ceiling or wall using the enclosed ceiling/wall mounting kit, as shown in Figure 2:

1. Using the plastic mounting bracket as a template, mark the location to insert the screw anchors.
2. Press the point of the screw anchors into the sheetrock at the marks and drive them into the wall using a Phillips-head screwdriver.
3. Insert the long screws through the recessed holes in the plastic mounting bracket and drive them into the metal anchors.
4. Drive the short screws into the threaded mounting points on the bottom of the BSAP until they are firmly seated in the receptacle. If extra space is required, use the spacers and long screws provided with the T-rail mounting hardware kit to increase the space between the unit and the mounting bracket. Leave enough of the long screws exposed above the spacer to ensure they can be inserted into the keyed slots on the mounting bracket.
5. Mount the BSAP on the mounting bracket by inserting the screws on the back of the BSAP into the keyed slots on the mounting bracket and rotating the unit clockwise 90 degrees to secure it on the bracket.
6. Optionally, protect your BSAP with a Kensington cable lock (not provided) inserted into the security slot.

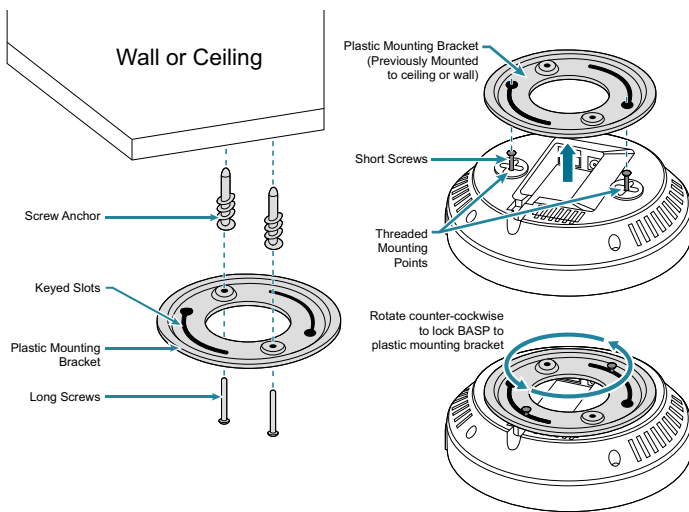

Figure 2. Mounting the BSAP to a Ceiling or Wall

Mounting the BSAP to a Dropped Ceiling

The BSAP ships with a T-rail mounting kit for mounting on the ceiling tile separators of standard dropped ceilings. The mounting clips come in two sizes and can be mounted to either recessed (using the spacer) or flush dropped ceiling T-rails. Position the BSAP for maximum throughput and range between other BSAPs and wireless client devices. To mount the BSAP to a dropped ceiling, complete the following:

1. Attach the appropriate size ceiling clips to the bottom cover of the BSAP using the provided short screws, see [Figure 3](#).

i NOTE

If extra space is required to accommodate recessed dropped ceiling tiles, use the provided spacers and longer screws included in the T-rail ceiling mount kit.

2. Once the ceiling clips are attached to the BSAP, line up the T-rail clips with an appropriately sized rail and press the unit onto the rail until it snaps into place.
3. Optionally, protect your BSAP with a Kensington cable lock (not provided) inserted in the security slot.

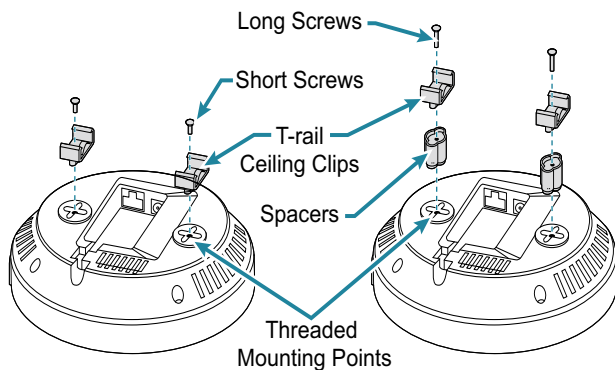

Figure 3. Attach ceiling clips to bottom cover of BSAP using short screws

Supplying Power to the BSAP

The BSAP does not have a power switch. It is powered when connected to a network device that supplies PoE based on the IEEE 802.3af standard, or an optional external PoE injector (P/N: 1700923F1), or by an optional external 1.25 amp DC power adapter (P/N: 1700928F1) connected to an AC power source. The BSAP is fully functional using 802.3af PoE and 802.3at PoE+. To use the external DC power adapter, connect the adapter to the **12V DC** port on the back of the unit. The DC power adapter automatically adjusts to any voltage between 100 and 240V AC at 50 or 60 Hz. No voltage range settings are required.

! CAUTION!

- If the BSAP is used in a medical environment, it must use an IEC/EN 60601-1 compliant power adapter.
- Ethernet and PoE cables are intended for intrabuilding use only. Connecting this device directly to cables that run outside the building in which the unit is housed will void the user's warranty and could create a fire or shock hazard.

USING THE AP WITH EXPRESS CLOUD

Express Cloud is now included with the purchase of new ADTRAN 2000 and 3000 series Access Points (APs). Express Cloud can be used with the AP, however Elite Cloud or Elite On-Premises can be purchased for access to upgraded features.

For initial setup of Express Cloud, complete the following:

1. Go to <https://adtran.com/cloud>, provide the requested information to create a new account. Express Cloud access information and credentials will be sent via email within one business day.
2. After receiving email confirmation, connect the AP to a power supply.
3. Connect the AP to an internet-accessed network. The AP will automatically discover Express Cloud and will display in the account.

For existing Express Cloud accounts adding additional APs, complete the following:

1. Go to <https://adtran.com/cloud>.
2. Using the same email address as the existing Express Cloud account in the email field and the domain name in the company field.
3. If using an email address that already has an account and a domain that already exists, you will be adding additional APs to that existing account and domain.
4. Confirmation that APs have been added will be sent via email within one business day.
5. After receiving email confirmation, connect the AP to a power supply.
6. Connect the AP to an internet-accessed network. The AP will automatically discover Express Cloud and will display in the account.

Express Cloud support is available in the ADTRAN interactive support community online at <https://supportforums.adtran.com>.

For further details regarding Express Cloud, Elite Cloud and Elite On-Premises, please refer to the FAQ in the support community. For further information on creating an Express Cloud account refer to Creating an Express Cloud Account in the support community.

USING THE AP WITH ELITE CLOUD

Purchasing an Elite Cloud subscription automatically creates a user cloud account. All further communication will be provided via email. For initial setup of Elite Cloud, complete the following:

NOTE

Elite Cloud access information and credentials will be sent via email within one business day.

1. After receiving email confirmation, connect the AP to a power supply.
2. Connect the AP to an internet-accessed network. The AP will automatically discover Elite Cloud and will display in the account.

For existing Elite Cloud accounts purchasing additional APs and Elite Cloud Subscriptions, complete the following:

NOTE

Confirmation that APs have been added will be sent via email within one business day.

1. After receiving email confirmation, connect the AP to a power supply.
2. Connect the AP to an internet-accessed network. The AP will automatically discover Elite Cloud and will display in the account.

USING THE AP WITH ELITE ON-PREMISES

The AP can be configured for use with Elite On-Premises, the Bluesocket virtual wireless local area network (vWLAN). Using AP discovery to configure the AP with a previously-installed vWLAN can be achieved by allowing the AP to discover the vWLAN and receive its configuration information. This AP discovery process uses an algorithm that attempts discovery methods in this order: static configuration, Dynamic Host Control Protocol (DHCP) vendor option (43), Domain Naming System (DNS) discovery, cached vWLAN info, and Express/Elite Cloud Zero Touch discovery. If no response to the discovery request is received, the algorithm moves to the next method in the list (except when using static configuration, which never queries the other discovery methods).

Two additional network components can be configured to facilitate AP discovery:

1. An external DHCP server can be configured to assign IP addresses to APs associated with the vWLAN. When configuring the DHCP server, make sure to configure the Bluesocket DHCP Vendor option (43) on the server.
2. An external DNS server can be configured to resolve the name **apdiscovery** to the IP address of the vWLAN in the network environment.

For more information on the vWLAN and AP discovery, please refer to the *vWLAN AP Discovery Configuration Guide* available online at <https://supportforums.adtran.com>.

CONNECTING TO THE AP

If powering the AP using a network device such as a switch, complete the following:

1. Connect the AP Ethernet port to the appropriate switchport.
2. Obtain the IP address of the AP from the Dynamic Host Control Protocol (DHCP) server based on the MAC address of the AP. DHCP is enabled by default.
3. Use a Secure Shell (SSH) client to connect to the AP.

If powering the AP using a PoE injector, complete the following:

1. Connect the Ethernet port of the AP to the **OUT** port of the PoE injector.
2. Connect the Ethernet port of the computer to the **IN** port on the PoE injector.
3. Use a Secure Shell (SSH) client to connect to the AP.

If the AP is powered using the optional DC power adapter, complete the following:

1. Connect the Ethernet port of the AP to the Ethernet port of the computer.
2. Use a Secure Shell (SSH) client to connect to the AP.

CONFIGURING THE AP'S IP ADDRESS OR STATIC DISCOVERY USING THE CLI

By default, DHCP is enabled on the AP. However, if static configuration is required for the IP address or AP discovery is required for the AP, users can access the AP's CLI using an SSH client.

To access the AP CLI using an SSH client, complete the following:

1. Ensure that the AP is connected to a controlling computer (using the provided RJ-45 Ethernet cable).
2. Specify that the computer's TCP/IP setting is **On** or **Enabled** by navigating to **Control Panel** and selecting **Network Connections**.
3. Double-click the connection of your network interface card and select **Internet Protocol (TCP/IP)**.
4. Select **Properties** then specify that the TCP/IP setting is enabled.
5. Set your PC to a static IP address of **192.168.190.2** with a subnet mask of **255.255.255.0**.
6. Access the AP's command line interface (CLI) using an SSH client.
7. Open an SSH connection using the unit's default IP address (**192.168.190.1**) and port 2335 connected to the **LAN1** port on the AP.
8. At the prompt, enter the username **adm1n** and the password **blue1socket**.



























Please indicate in your request that this is a GPL Source Request. Please also identify the requested product's part number. This offer is valid to anyone in receipt of this information.

CONFIGURING THE APPLICATION

More detailed documentation for configuring the BSAP is provided in the *vWLAN Administrator's Guide*, available online at <https://supportforums.adtran.com>.

BSAP LED Description

Status is indicated by the following front panel LEDs:

LED ARRAY			BSAP STATE
 (Orange Solid)	 (Off)	 (Off)	Boot Loader Initialization
 (Off)	 (Off)	 (Green Solid)	Operating System Initialization
 (Off)	 (Orange Flashing)	 (Green Flashing)	LAN Initialization
 (Off)	 (Green Flashing)	 (Green Flashing)	Discovering vWLAN
 (Orange Flashing Slow)	 (Green Flashing)	 (Off)	Firmware Upgrade (download)
 (Orange Flashing Fast)	 (Green Flashing)	 (Off)	Firmware Upgrade (writing or Verifying)
 (Orange Solid)	 (Green Flashing)	 (Off)	Firmware Upgrade Complete
 (Green Solid)	 (Green Flashing)	 (Green Solid)	Operational with No Activity on Radios
 (Green Flashing)	 (Green Flashing)	 (Green Solid)	Operational with Activity on Radios

FCC RADIO FREQUENCY INTERFERENCE

This device complies with Part 15 of the Federal Communications Commission (FCC) rules. The operation of this device is subject to the following two conditions:

1. This device may not cause harmful interference.
2. This device must accept any interference received including interference that may cause undesired operation.



NOTE

Additional safety and regulatory guidelines are given in the document *Bluesocket Compliance Notice* available online at <https://supportforums.adtran.com>.

THIRD-PARTY SOFTWARE

The software included in this product contains copyrighted software that is licensed under the GNU General Public License (GPL). You may obtain the complete corresponding source code of such software components from ADTRAN for a period of three years after our last shipment of this product.

If electronic distribution is desired, you may send your request to OpenSourceReviewBoard@adtran.com.

If distribution on physical media is desired, you may send a request, together with a money order or check for \$5, to:

ADTRAN, Inc.
Attn: OSRB Coordinator
901 Explorer Blvd.
Huntsville, AL 35806

Please indicate in your request that this is a GPL Source Request. Please also identify the requested product's part-number. This offer is valid to anyone in receipt of this information

MAINTENANCE

The BSAP does not require routine hardware maintenance for normal operation. ADTRAN does not recommend that repairs be attempted in the field. Repair services may be obtained by returning the defective unit to ADTRAN. Refer to the warranty for further information. Field support for software is provided through upgrade facilities.

Acronyms

BSAP	Bluesocket 2020 Series Access Point
CLI	Command Line Interface
DHCP	Dynamic Host Configuration Protocol
DNS	Domain Name System
LED	Light Emitting Diode
PIFA	Planar Inverted F Antenna
PoE	Power Over Ethernet
SSH	Secure Shell
TCP/IP	Transmission Control Protocol/Internet Protocol
vWLAN	Virtual Wireless Local Area Network

SAFETY AND REGULATORY

Refer to the Safety and Regulator Notice for this product (P/N: 1700962F1-17) for detailed safety and regulatory information.

Consultez l'avis sur la sécurité et la conformité à la réglementation pour ce produit (61700962F1-17) pour obtenir des renseignements détaillés sur la sécurité et la réglementation.

Ausführliche Sicherheits- und regulatorische Informationen sind in der Konformitätserklärung zur Sicherheit und Einhaltung von Normen zu diesem Produkt (61700962F1-17) aufgeführt.

Documentation for ADTRAN Network Solutions products is available for viewing and download directly from the ADTRAN Support Community website.

Go to: <https://supportforums.adtran.com/welcome>

Registration is required.

ADTRAN offers training courses on our products, including customized training and courses taught at our facilities or at customer sites.

For inquiries, go to: <http://adtran.com/training>

The following online documents and resources provide additional information for this product:

Bluesocket Compliance Notice

vWLAN Administrator's Guide

vWLAN AP Discovery Configuration Guide

Warranty: ADTRAN will replace or repair this product within the warranty period if it does not meet its published specifications or fails while in service. Warranty information can be found online at www.adtran.com/warranty.

Trademarks: Brand names and product names included in this document are trademarks, registered trademarks, or trade names of their respective holders.

Copyright © 2019 ADTRAN, Inc. All Rights Reserved.



ADTRAN CUSTOMER CARE:
From within the U.S. 1.888.423.8726
From outside the U.S. +1 256.963.8716
PRICING AND AVAILABILITY 1.800.827.0807

