

DDM+ HDSL Transceiver Unit for Central Office Installation and Maintenance Practice

Document Number: 61247003L1-5A

CLEI: T113AALA__

April 2008

Trademarks

Any brand names and product names included in this document are trademarks, registered trademarks, or trade names of their respective holders.

To the Holder of this Document

The contents of this document are current as of the date of publication. ADTRAN® reserves the right to change the contents without prior notice.

In no event will ADTRAN be liable for any special, incidental, or consequential damages or for commercial losses even if ADTRAN has been advised thereof as a result of issue of this document.



901 Explorer Boulevard
P.O. Box 140000
Huntsville, AL 35814-4000
(256) 963-8000

©2008 ADTRAN, Inc.
All Rights Reserved.

Revision History

Revision	Date	Description
A	April 2008	Initial release

Conventions

The following typographical conventions are used in this document:

[This font](#) indicates a cross-reference link.

This font indicates screen menus, fields, and parameters.

THIS FONT indicates keyboard keys (ENTER, ESC, ALT). Keys that are to be pressed simultaneously are shown with a plus sign (ALT+x indicates that the ALT key and x key should be pressed at the same time).

This font indicates references to other documentation and is also used for emphasis.

This font indicates on-screen messages and prompts.

This font indicates text to be typed exactly as shown.

This font indicates silk-screen labels or other system label items.

This font is used for strong emphasis.

NOTE

Notes inform the user of additional, but essential, information or features.

CAUTION

Cautions inform the user of potential damage, malfunction, or disruption to equipment, software, or environment.

WARNING

Warnings inform the user of potential bodily pain, injury, or death.

Training

ADTRAN offers training courses on our products. These courses include overviews on product features and functions while covering applications of ADTRAN product lines. ADTRAN provides a variety of training options, including customized training and courses taught at our facilities or at customer sites.

For inquiries concerning training, contact ADTRAN:

Training Phone: 800-615-1176, ext. 6996

Training Fax: 256-963-6217

Training Email: training@adtran.com

Contents

Introduction	1
Description	2
Compliance	3
HDSL Deployment Guidelines	5
Installation	7
Shipping Contents	7
Shelf Population (Based on Power Requirements)	8
Line Build Out Switch	8
Instructions for Installing the DDM+ HTU-C	8
Provisioning	9
Front Panel LEDs	10
Connections	11
Alarm Connections	12
Control Port Operation	13
User Interface	14
Menu Structure	14
Menu	14
Screen	14
Menu Navigation	14
Screen Abbreviations	15
Menu Descriptions	16
Current System Status Screens	19
Current System Status - HRE Screen	21
Performance History Screen	22
Performance History - HRE Screen	23
Loopback Options Menu	24
Self Test Options Screen	25
Provisioning Menu	25
Troubleshooting Display Screen	26
Alarm History Screen	27
Set Time/Date/Circuit ID Menu	28
Default Options Screen	29
HDSL System Testing	30
DDM+ HTU-C Bantam Jacks	30

DDM+ HTU-C Loopbacks	30
Troubleshooting Procedures	32
Maintenance	32
Specifications	33
Appendix A	
HDSL Loopbacks	A-1
HDSL Maintenance Modes	A-1
DDM+ HTU-C Loopback	A-1
HTU-R Loopback	A-1
HRE Loopback	A-1
Loopback Process Description	A-2
HDSL Loopback Codes	A-3
Appendix B	
DS0 Blocking	B-1
Appendix C	
Shelf Configuration	C-1
DDM Plus Shelf Population (Power Requirements)	C-1
Appendix D	
Warranty	D-1
Warranty and Customer Service	D-1
ADTRAN Sales	D-1
ADTRAN Technical Support	D-1
ADTRAN Repair/CAPS	D-1
Repair and Return Address	D-1

Figures

Figure 1.	DDM+ HTU-C front panel	1
Figure 2.	HDSL Deployment Guidelines	5
Figure 3.	DDM+ HTU-C Edge Connector Wiring	11
Figure 4.	DDM+ HTU-C Span Powering Diagram	12
Figure 5.	RS-232 (DB9) Pin Assignments	13
Figure 6.	Introductory Menu Screen	16
Figure 7.	HDSL Main Menu	17
Figure 8.	Current System Status Screen	19
Figure 9.	Current System Status - HRE Screen	21
Figure 10.	Performance History Screen	22
Figure 11.	Performance History - HRE Screen	23
Figure 12.	Loopback Options Screen	24
Figure 13.	Self-Test Options Screen	25
Figure 14.	Provisioning Menu	25
Figure 15.	Troubleshooting Display Screen	26
Figure 16.	Alarm History Screen	27
Figure 17.	Set Time/Date/Circuit ID Screen	28
Figure 18.	Default Options Screen	29
Figure 19.	HDSL Loopbacks	31
Figure A-1.	HDSL Loopback Points	A-1
Figure A-2.	HDSL Element State Diagram	A-2

Tables

Table 1.	HDSL Compatibility	2
Table 2.	Compliance Codes	3
Table 3.	HDSL Loss Values	6
Table 4.	Loop Insertion Loss Data	6
Table 5.	Line Build Out Switch Settings	8
Table 6.	Provisioning Options	9
Table 7.	Front Panel LEDs	10
Table 8.	Screen Abbreviations	15
Table 9.	HDSL Main Menu Options	17
Table 10.	HDSL, DS1, and DSX-1 Key Definitions	19
Table 11.	Pair Reversal Key Definitions	20
Table 12.	HDSL Loop Signal Quality	20
Table 13.	ADTRAN Noise Margin Guidelines	20
Table 14.	DDM+ HTU-C Troubleshooting Guide	32
Table 15.	DDM+ HTU-C Specifications	33
Table A-1.	HDSL Loopback Control Codes	A-3

This page is intentionally blank.

HDSL DDM+ Transceiver Unit for Central Office

INTRODUCTION

The ADTRAN HDSL DDM+ HDSL Transceiver Unit for Central Office (DDM+ HTU-C) is used to deploy a repeaterless T1 circuit using 4-wire metallic facilities. The DDM+ HTU-C (P/N 1247003L1) occupies one slot in a DDM+ DS1 Extension shelf. The DDM+ HTU-C front panel is illustrated in [Figure 1](#).

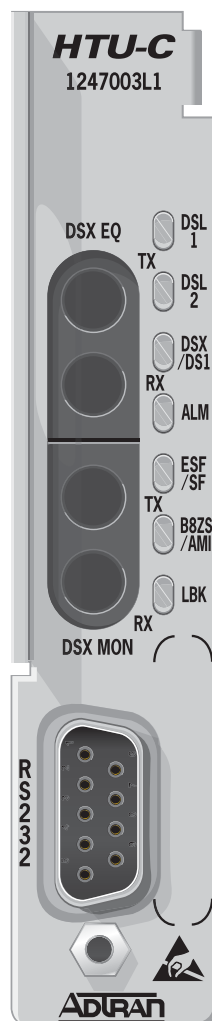

Figure 1. DDM+ HTU-C front panel

Description

DSX-1 signals are provided to and from the network while 2B1Q HDSL signals are provided to the local loop. The DDM+ HTU-C works in conjunction with the ADTRAN HDSL Transceiver Unit for the Remote end (HTU-R) and HDSL Range Extender (HRE) to provide a DS1 service up to 36,000 feet on the local loop.

The DDM+ HTU-C works with multiple list versions of the HTU-R and HRE as listed below in [Table 1](#).

Table 1. HDSL Compatibility

Part Number	Description
1245024L1	T400 HTU-R w/Local Power Option
1246026Lx	6th Gen HTU-R
1247024Lx	7th Gen HTU-R, Local Power
1247026L1	7th Gen HTU-R, Span Power
1246041L1	6th Gen T200 HRE
1246045L1	6th Gen 239 HRE
1247041L1	7th Gen T200 HRE
1247045L1	7th Gen 239 HRE

x = any number

The DDM+ HTU-C can be deployed in circuits consisting of one HTU-C and one HTU-R. When deployment requires the HRE, the DDM+ HTU-C can be deployed with one or two HREs and one HTU-R.

The HDSL local loop operates as two independent subsystems each operating over a single twisted pair. The DDM+ HTU-C communicates over these two twisted pairs to the HTU-R. Each subsystem carries half of the total bandwidth along with a small amount of overhead used for maintenance and performance monitoring related functions.

System power and alarm bus connections are made through the backplane of the DDM+ shelf. DSX-1 and HDSL signals are connected through the wire-wrap pins related to each individual slot located on the rear of the shelf.

The DDM+ HTU-C contains an onboard fuse. If the fuse opens, it supplies –48 VDC to the fuse alarm bus and all front panel indicators turn off. This fuse is not field-replaceable.

The DDM+ HTU-C uses a DC-to-DC converter to derive its internal logic and span powering voltages from the –48 VDC office supply.

The DDM+ HTU-C can provide span power for HREs and an HTU-R as described above. The –190 VDC span powering voltages meet all the requirements for Class A2 of Bellcore GR-1089-CORE.

Compliance

The DDM+ HTU-C is NRTL listed to the applicable UL standards for continuous use in -40°C to $+50^{\circ}\text{C}$ environmental conditions. Care should be exercised when handling equipment when temperatures at these extremes exist, as surfaces could be very cold or hot.

The DDM+ HTU-C meets or exceeds all the applicable requirements of NEBS, Telcordia GR-63-CORE and GR-1089-CORE and is evaluated to ensure proper operational performance is maintained if environmental conditions ranging from -40°C to $+71^{\circ}\text{C}$ are encountered.

The DDM+ HTU-C is intended for deployment in central office type facilities, EEEs, EECs, and locations where the NEC applies (for example, customer premises). Install the DDM+ HTU-C in the appropriate chassis, which is intended to be installed only in Restricted Access Locations by qualified personnel.

Table 2 shows the compliance codes for the DDM+ HTU-C.

Table 2. Compliance Codes

Code	Input	Output
Power Code (PC)	F	C
Telecommunication Code (TC)	–	X
Installation Code (IC)	A	–

This device complies with Part 15 of the FCC rules. Operation is subject to the following two conditions:

1. This device may not cause harmful interference.
2. This device must accept any interference received, including interference that may cause undesired operation.

Changes or modifications not expressly approved by ADTRAN could void the user's authority to operate this equipment.

WARNING

Voltages up to -200 VDC with respect to ground may be present on the HDSL telecommunications conductors. Voltages up to 200 VDC may be present between individual HDSL telecommunications conductors.

CAUTION

Per GR-1089-CORE the HDSL System is designed and intended for installation as part of a Common Bonding Network (CBN). The HDSL System is not designed nor intended for installation as part of an Isolated Bonding Network (IBN).

CAUTION

Per GR-1089-CORE Section 9, the DDM+ HTU-C does not have an internal DC connection between battery return and frame ground. As such, it may be installed in a DC-I (isolated) or DC-C (common) installation. For installations where other cards or the host system have internal connections between battery return and frame ground, the system would be intended for deployment only in a DC-C installation.

NOTE

The HDSL port is classified as Type 1, 3, and 5, as defined in Appendix B of GR-1089-CORE Issue 4, and meets the lightning and power fault criteria with any primary protector that meets any of the voltage limits of GR-974-CORE or GR-1361-CORE (for example, carbon blocks, gas tubes, solid states, etc.).

NOTE

The DSX-1 port is classified as Type 2 or 4 as defined in Appendix B of GR-1089-CORE Issue 4, and is suitable for connection to intra-building or unexposed wiring or cabling only. Do not metalically connect this port to interfaces which connect to the Outside Plant (OSP) or to the OSP wiring. The DSX-1 port is designed for use as an intra-building interface only (Type 2 or Type 4 ports as described in GR-1089-CORE Issue 4) and requires isolation from exposed OSP cabling. The addition of Primary Protectors is not sufficient protection in order to connect this interface metalically to OSP wiring.

NOTE

The DDM+ HTU-C is designed to operate with a nominal operating voltage of -48 VDC and a minimum operating voltage of -40 VDC. The DDM+ HTU-C will not be damaged by any steady state voltage below -56.7 VDC.

NOTE

Current limiting protectors are not required.

HDSL DEPLOYMENT GUIDELINES

The ADTRAN HDSL system is designed to provide DS1 based services over loops designed to comply with carrier service area (CSA) guidelines. CSA deployment guidelines are given below.

- All loops are non-loaded only.
- For loops with 26-AWG cable, the maximum loop length including bridged tap lengths is 9 kft.
- For loops with 24-AWG cable, the maximum loop length including bridged tap lengths is 12 kft.
- Any single bridged tap is limited to 2 kft.
- Total bridged tap length is limited to 2.5 kft.
- The total length of multi-gauge cable containing 26-AWG cable must not exceed the following:
 - $12 - \{(3 \times L_{26}) / (9 - L_{BTAP})\}$ (in kft)
 - L_{26} = Total length of 26-AWG cable excluding bridged taps (in kft)
 - L_{BTAP} = Total length of all bridged taps (in kft)

This deployment criteria is summarized in the chart shown in [Figure 2](#).

Loop loss per kft for other wire is summarized in [Table 3](#).

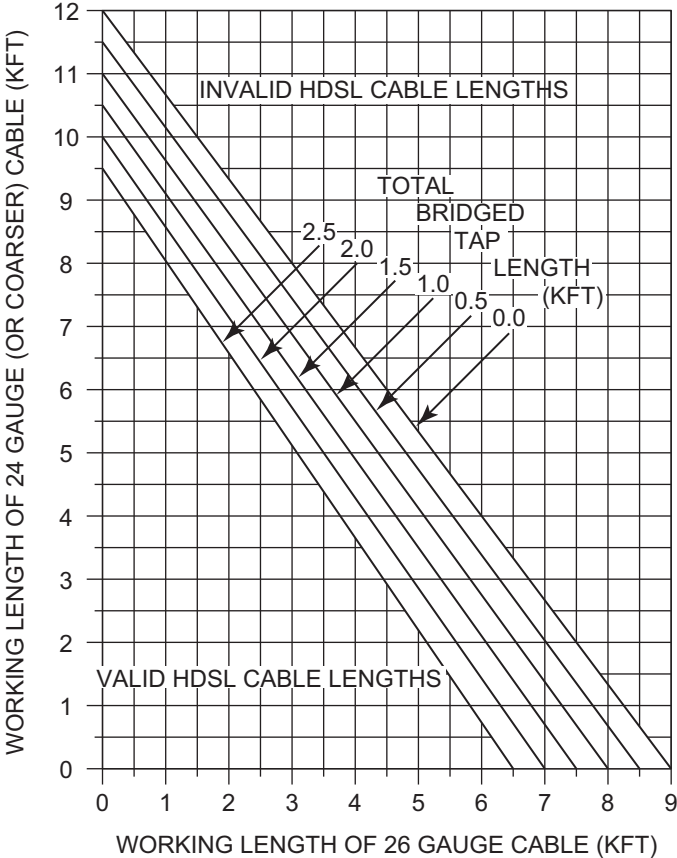

Figure 2. HDSL Deployment Guidelines

Table 3. HDSL Loss Values
(200kHz cable loss in dB/kft at 135 Ω)

Cable Gauge	Cable Type	Temperature:		
		68°	90°	120°
26	PIC	3.902	4.051	4.253
26	Pulp	4.030	4.179	4.381
24	PIC	2.863	2.957	3.083
24	Pulp	3.159	3.257	3.391
22	PIC	2.198	2.255	2.333
22	Pulp	2.483	2.45	2.629
19	PIC	1.551	1.587	1.634
19	Pulp	1.817	1.856	1.909

Recommended maximum local loop loss information for PIC cable at 70°F, 135 Ω , resistive termination is provided in [Table 4](#).

Table 4. Loop Insertion Loss Data

Frequency (Hz)	Maximum Loss (dB)
3,000	12.0
10,000	15.0
50,000	25.5
100,000	30.0
150,000	32.75
196,000	35.00
200,000	35.25

An approximation for the maximum amount of wideband noise on an HDSL local loop as measured by a 50 kbps filter is ≤ 31 dBn.

An approximation for the maximum level of impulse noise as measured using a 50 kbps filter on an HDSL loop is ≤ 50 dBn.

NOTE

These approximations are to be used as guidelines only and may vary slightly on different loops. Adhering to the guidelines should produce performance in excess of 10^{-7} BER.

INSTALLATION

CAUTION



CAUTION!

SUBJECT TO ELECTROSTATIC DAMAGE
OR DECREASE IN RELIABILITY.

HANDLING PRECAUTIONS REQUIRED.

Electrostatic Discharge (ESD) can damage electronic modules. When handling modules, wear an antistatic discharge wrist strap to prevent damage to electronic components. Place modules in antistatic packing material when transporting or storing. When working on modules, always place them on an approved antistatic mat that is electrically grounded.

After unpacking the DDM+ HTU-C, immediately inspect it for possible shipping damage. If damage is discovered, file a claim immediately with the carrier, then contact ADTRAN Customer Service. For more information, refer to see [“Appendix D, Warranty”](#).

The DDM+ HTU-C plugs directly into the DDM+ shelf. The DDM+ HTU-C may be plugged into any of the 28 numbered slots in this shelf. No installation wiring is required.

NOTE

When the DDM+ HTU-C is powered down, changing a single hardware option setting causes a global reset to revert back to all hardware switch settings (including the removal of DSO blocking parameters).

Shipping Contents

The contents include the following items:

- HDSL DDM+ HDSL Transceiver Unit for Central Office
- *HDSL DDM+ Transceiver Unit for Central Office Job Aid* (P/N 61247003L1-22)
- *HDSL DDM+ Transceiver Unit for Central Office Compliance Notice* (P/N 61247003L1-17)

Shelf Population (Based on Power Requirements)

Typically the DDM+ shelf is fused at 10 amps per side (one half of the shelf). Refer to “[Appendix C, Shelf Configuration](#)” for more information on calculating the maximum number of DDM+ HTU-Cs allowed in the DDM+ Shelf.

Several DDM+ HTU-Cs can be mixed with other DDM+ standard plug-ins, providing that the total current draw per shelf side is less than or equal to 5 amps. Refer to the original equipment manufacturer's specifications for more detail on specific power requirements of these units.

Line Build Out Switch

The line build out switch is located on the printed circuit board. Manual configuration should be performed prior to installing the DDM+ HTU-C. The available settings are shown in [Table 5](#).

Table 5. Line Build Out Switch Settings

Switch Setting	DIP Switch			Line Length of Cable (in feet)
	1	2	3	
0	ON	ON	ON	0–133 (default setting)
133	ON	ON	OFF	133–266
266	ON	OFF	ON	266–399
399	ON	OFF	OFF	399–533
533	OFF	ON	ON	533–655

Instructions for Installing the DDM+ HTU-C

To install the DDM+ HTU-C, perform the following steps:

1. Hold the DDM+ HTU-C by the front panel while supporting its bottom edge to engage the chassis edge.
2. Align the DDM+ HTU-C edges to fit in the lower and upper guide grooves for the module slot.
3. Slide the DDM+ HTU-C into the module slot. Simultaneous thumb pressure at the top (above the **DSL1** LED) and at the bottom (below the electrostatic caution symbol) of the DDM+ HTU-C will ensure that it is firmly positioned against the backplane of the chassis.

When the DDM+ HTU-C first powers up it runs the power up self-tests. Once the power up self-tests are complete, the status LEDs reflect the true state of the hardware.

Provisioning

Provisioning is performed via software. For more information, refer to the “[Control Port Operation](#)” section of this practice.

The provisioning settings can be viewed and manipulated through management access via the front panel RS-232 port. [Table 6](#) lists the available provisioning options and their factory default settings.

Table 6. Provisioning Options

Provisioning Option	Settings	Default
DSX-1 Line Buildout	0–133 feet; 133–266 feet; 266–399 feet; 399–533 feet; 533–655 feet	0–133 feet
DSX-1/DS1 Line Code	B8ZS; AMI	B8ZS
DSX-1/DS1 Framing	Auto; ESF; SF; Unframed; Forced Conversion	Auto
NIU Loopback	Enabled; Disabled	Enabled
New England 1:6 LPBK	Disabled; Enabled	Disabled
Loopback Timeout	None; 60 Min.; 120 Min.	120 Min.
Customer Loss Response	AIS; CDI; Loopback	AIS
Latching Loopback Mode	T1; FTI	T1
PRM Mode	None; NPRM; SPRM	None
DS1 TX Level	0 db; –15 db	0 db
HTUC Shelf Alarm	Enabled; Disabled	Disabled
Span Power	Enabled; Disabled	Enabled
DSO Blocking	None blocked; Any of 01–24 blocked or unblocked	None blocked

Front Panel LEDs

LED indicators on the front panel of the DDM+ HTU-C provide the status of the HDSL circuit. The LED indications and their descriptions are shown in [Table 7](#).

Table 7. Front Panel LEDs

Label	Status	Description
DSL 1/ DSL 2	○ Off	No sync between the HTU-C and HTU-R on Loop 1/Loop 2
	● Green	Signal quality is good (4 to 9)
	● Yellow	Signal Quality is marginal (1 to 3)
	● Red	Signal quality is poor (0)
	⊛ Flashing	Error detected at HTU-C or HTU-R. The color of the LED, when flashing, indicates loop signal quality
DSX/ DS1	○ Off	DSX signal is not detected or is of a format that does not match the provisioning of the HDSL circuit
	● Green	DSX signal is present and synchronized with the HTU-C interface
	⊛ Flashing	Bipolar violation (BPV), frame bit error (SF mode) or CRC error (ESF mode) detected on received DSX signal
ALM	○ Off	No alarm conditions exist
	● Yellow	Remote alarm condition (HTU-R) detected
	● Red	Alarm condition detected either locally (HTU-C) or locally and remotely (HTU-C and HTU-R)
ESF/ SF	○ Off	DDM+ HTU-C is receiving or is provisioned for unframed
	● Green	DDM+ HTU-C is currently receiving SF data, except when provisioned for unframed
	● Yellow	DDM+ HTU-C is currently receiving ESF data, except when provisioned for unframed
B8ZS/ AMI	● Green	DDM+ HTU-C is receiving AMI line code
	● Yellow	DDM+ HTU-C is receiving B8ZS line code
LBK	○ Off	DDM+ HTU-C is not armed or in loopback
	● Yellow	DDM+ HTU-C is in loopback toward the network
	⊛ Yellow Flashing	Loopback arming sequence detected and the DDM+ HTU-C is armed (ready for loopback) but not in loopback

CONNECTIONS

The DDM+ HTU-C occupies one card slot in a DDM+ shelf. Power and alarm signals are provided to the card through the backplane of the shelf. DSX-1 and HDSL loop signals are connected to the shelf connector and transmitted to the corresponding slot the DDM+ HTU-C occupies. Connections to the DSX-1 pins are intended for intra-building wiring only. Refer to [Figure 3](#) for the DDM+ HTU-C edge connection wiring.

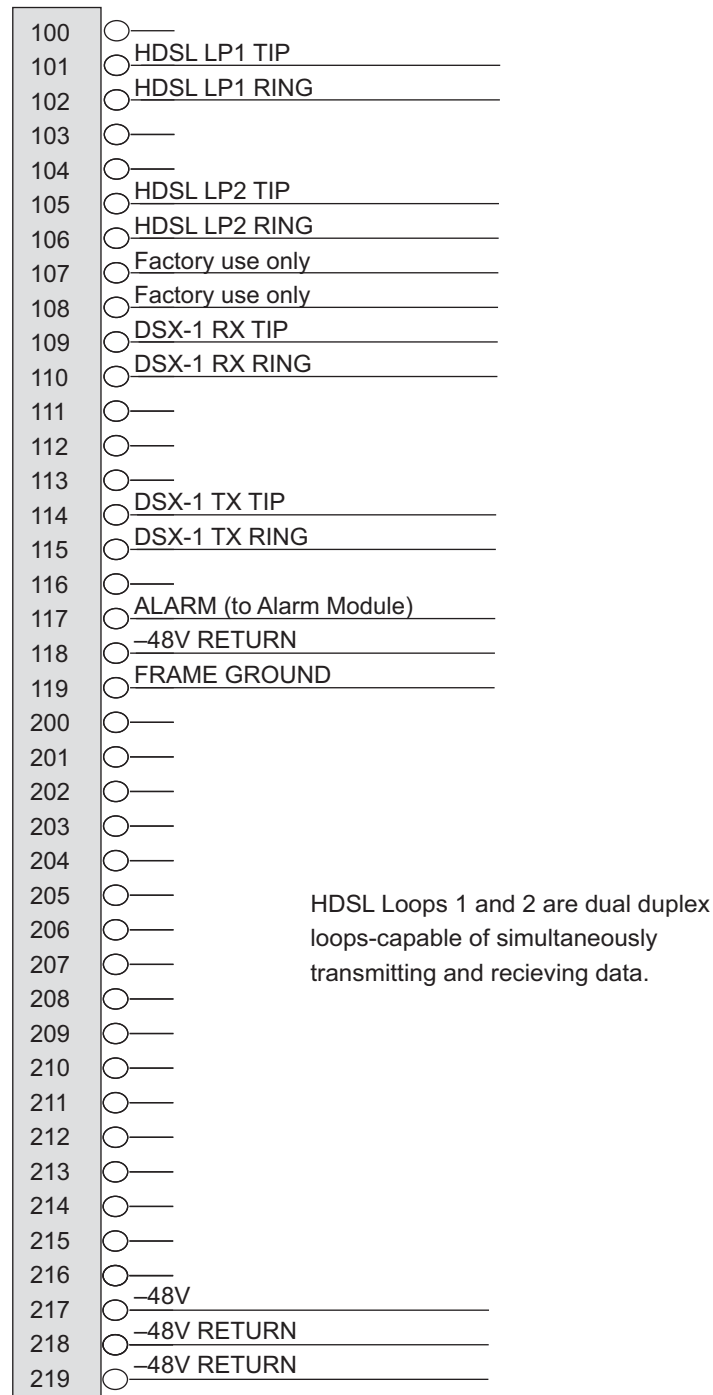

Figure 3. DDM+ HTU-C Edge Connector Wiring

The DDM+ HTU-C is capable of span powering the HTU-R by applying simplex current to the local loop. From 0 to 125 mA of current is coupled onto the HDSL span to power the HTU-R and HRE when deployed. The span powering voltage is -190 volts with Loop 1 providing the negative voltage and Loop 2 the return, as shown in [Figure 4](#).

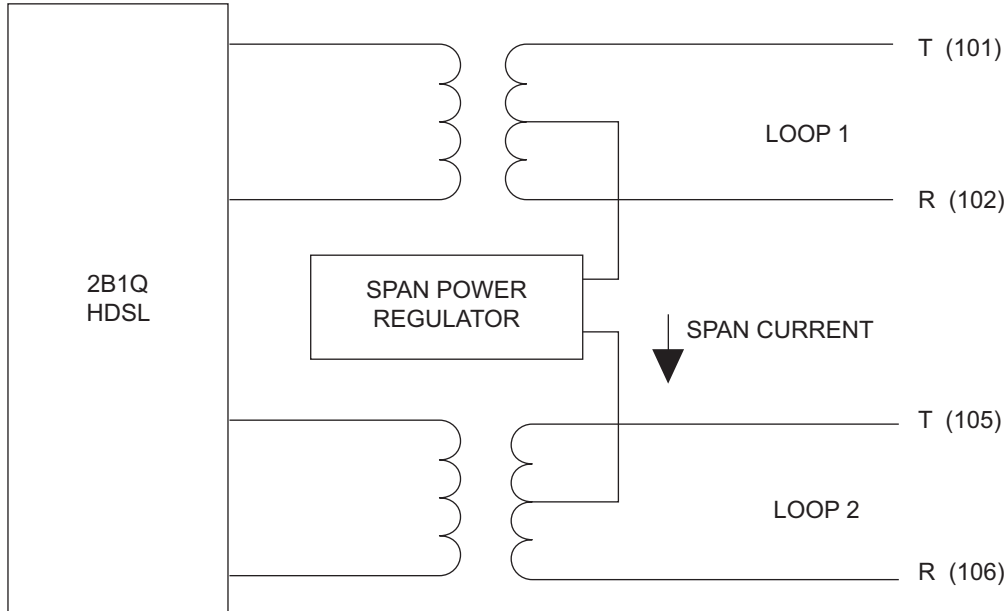

Figure 4. DDM+ HTU-C Span Powering Diagram

Alarm Connections

The following alarm signal is connected to the DDM+ Alarm Module:

- Pin 117
- Label LOS and Fuse Alarm
- Function Loss of signal and fuse alarm of -48 V supply

Alarm processing is actually performed by the DDM+ Alarm module. Refer to the DDM+ Alarm module documentation for further information.

Alarm conditions are not reported at the DDM+ HTU-C until the HDSL circuit is terminated by connecting an HTU-R. This allows circuit pack pre-provisioning. Once the DDM+ HTU-C is terminated with an HTU-R, the DDM+ HTU-C will go into an in-service state.

CONTROL PORT OPERATION

The DDM+ HTU-C provides a faceplate-mounted DB9 connector that supplies an RS-232 interface for connection to a controlling terminal. The pinout of the DB9 is illustrated in Figure 5.

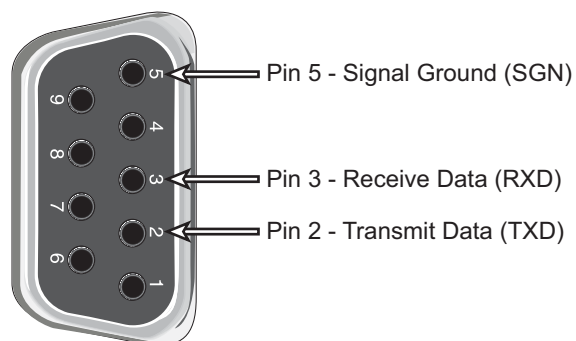

Figure 5. RS-232 (DB9) Pin Assignments

The terminal interface operates at data rates from 1.2 kbps to 19.2 kbps. The asynchronous data format is fixed at 8 data bits, no parity, and 1 stop bit. The supported terminal type is VT100 or compatible.

NOTE

If using a personal computer (PC) with terminal emulation capability, be sure to disable any power saving programs. Otherwise, communication between the PC and the HDSL unit may be disrupted, resulting in misplaced characters or screen time-outs.

USER INTERFACE

This section provides detailed information on the following:

- [Menu Structure](#)
- [Menu Navigation](#)
- [Screen Abbreviations](#)

Menu Structure

The DDM+ HTU-C uses a layered menu tree. Each layer of the menu tree is displayed as a menu or a screen.

Menu

A menu is a display that provides numbered selections that are used to navigate to related menus, modify provisioning information, or display information screens. A menu can contain the following objects:

- **Menu Option:** A menu option is indicated by a number, which when selected navigates the display to another menu layer or is used to change the option setting.
- **Read-only Field:** A read-only field displays information that cannot be changed. The information displayed in a read-only field can be static or can be automatically updated by the DDM+ HTU-C.
- **Read-write Field:** A read-write field displays information that when selected can be modified.
- **Hot Key:** A hot key is a key or combination of keys that are assigned to a function. Hot keys are indicated by the required key(s) and a brief description (i.e., D - Restore factory Defaults).

Screen

A screen is a display that usually indicates the end of a menu tree path. A screen can contain the following objects:

- **Read-only Field:** A read-only field displays information that cannot be changed. The information displayed in a read-only field can be static or can be automatically updated by the DDM+ HTU-C.
- **Read-write Field:** A read-write field displays information that when selected can be modified.
- **Hot Key:** A hot key is a key or combination of keys that are assigned to a function. Hot keys are indicated by the required key(s) and a brief description (i.e., D - Restore factory Defaults).

Menu Navigation

Basic menu navigation is accomplished by selecting the desired option number and then pressing ENTER. To return to the previous menu, press the escape (Esc) key. To access the System Help screen, press the question mark (?) key.

Screen Abbreviations

Table 8 lists the abbreviations used in the screen examples shown in Figures 6 through 18.

Table 8. Screen Abbreviations

Abbreviation	Definition
ES	Errored Seconds <ul style="list-style-type: none"> • DSX/DS1 <ul style="list-style-type: none"> – SF: Second in which a BPV or frame bit error occurs – ESF: Second in which a BPV or CRC error occurs • HDSL <ul style="list-style-type: none"> – Second in which a CRC error occurs
SES	Severely Errored Seconds. <ul style="list-style-type: none"> • DSX/DS1 <ul style="list-style-type: none"> – SF: Second in which 1544 BPVs or 8 frame bit errors occurs – ESF: Second in which 1544 BPVs or 320 CRC errors occur • HDSL <ul style="list-style-type: none"> – Second in which 165 CRC errors occurs
UAS	Unavailable Seconds <ul style="list-style-type: none"> • DSX/DS1 <ul style="list-style-type: none"> – Second in which there is a loss of signal or sync • HDSL <ul style="list-style-type: none"> – Second in which there is a loss of signal or sync
SF	Superframe Format
ESF	Extended Superframe Format
B8ZS	Binary 8 Zero Substitution
AMI	Alternate Mark Inversion
LBO	Line Build Out
BPV	Bipolar Violation <ul style="list-style-type: none"> • DSX/DS1 <ul style="list-style-type: none"> – Second in which a bipolar violation occurs
NIU	T1 Network Interface Unit
S/N	Serial number
15M	Fifteen-Minute Period
24H	Twenty-Four-Hour Period

MENU DESCRIPTIONS

The following subsections describe the DDM+ HTU-C menu screens. A terminal session is initiated by entering multiple space bar characters, which will determine the speed of the terminal. Once the speed has been determined, an Introductory menu will appear. This screen is illustrated in [Figure 6](#).

NOTE

The screens illustrated in [Figures 6](#) through [18](#) apply to an HDSL circuit deployed with ADTRAN's HDSL technology, using an DDM+ HTU-C, an HTU-R, and two HREs. This sample configuration was chosen in order to illustrate as much functionality as possible; however, other configurations are possible and their displays will vary slightly from those shown in this section.

```

Circuit ID:HNTSVLALHDSL                                MM/DD/YY hh:mm:ss
                                ADTRAN
                                901 Explorer Boulevard
                                Huntsville, Alabama 35806-2807

----- For Information or Technical Support-----
Support Hours ( Normal 7am - 7pm CST, Emergency 7 days x 24 hours )
Phone: 800.726.8663 / 888.873.HDSL Fax: 256.963.6217 Internet: www.adtran.com
-----
HTU-C INFORMATION                                     HTU-R INFORMATION
-----
S/N : 1234567890                                     S/N : 123456789
CLEI: T1I3AALAAA                                     CLEI: T1I3AAUAAA
MANF: 02/08                                          MANF: 02/08

HRE #1 INFORMATION                                   HRE #2 INFORMATION
-----
S/N : B916B7813                                     S/N : B916B7813
CLEI: T1RPAABBAA                                    CLEI: T1RPAABBAA
MANF: 02/08                                          MANF: 02/08

Press "M" to view Main Menu.

```

Figure 6. Introductory Menu Screen

HDSL Main Menu

The ADTRAN HDSL Main Menu, illustrated in [Figure 7](#), is selected from the Introductory menu by pressing “M.” Various Operation, Administrative, Maintenance, and Provisioning (OAM&P) screens may be accessed from the Main Menu.

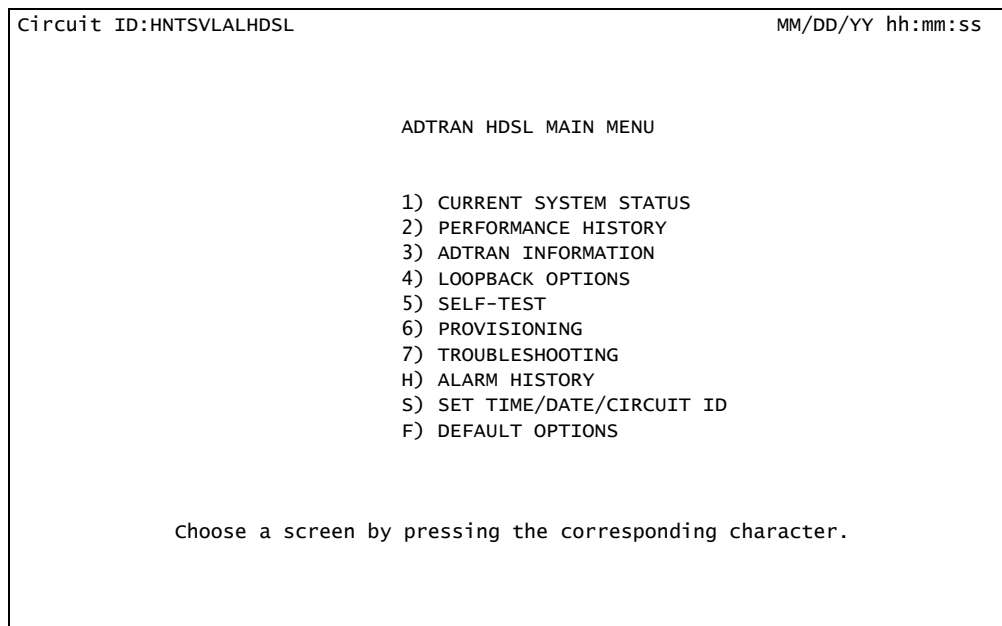

Figure 7. HDSL Main Menu

A list of options for the HDSL Main Menu and their descriptions can be found in [Table 9](#).

Table 9. HDSL Main Menu Options

Option	Description	Function
1	Current System Status	This option displays the “ Current System Status Screen ” on page 19.
2	Performance History	This option displays the “ Performance History Screen ” on page 22.
3	ADTRAN Information	This option displays the “ Introductory Menu Screen ” on page 16.
4	Loopback Options	This option displays the “ Loopback Options Screen ” on page 24.
5	Self-Test	This option displays the “ Self-Test Options Screen ” on page 25.
6	Provisioning	This option displays the “ Provisioning Menu ” on page 25.
7	Troubleshooting	This option displays the “ Troubleshooting Display Screen ” on page 26.

Table 9. HDSL Main Menu Options (Continued)

Option	Description	Function
H	Alarm History	This option displays the “ Alarm History Screen ” on page 27.
S	Set Time/Date/ Circuit ID	This option displays the “ Set Time/Date/Circuit ID Screen ” on page 28.
F	Default Options	This option displays the “ Default Options Screen ” on page 29.

Current System Status Screens

The Current System Status screen, illustrated in [Figure 8](#), provides quick access to status information for both the DDM+ HTU-C and the HTU-R.

```

Circuit ID:HNTSVLALHDSL                                     MM/DD/YY hh:mm:ss
LOOP #1 <NETWORK> LOOP #2   CURRENT SYSTEM STATUS   LOOP #1 <CUSTOMER> LOOP #2
-----HTU-C-----
29(29) dB      29(29) dB      <- LOSS (CUR MAX) ->   29(29) dB      30(30) dB
YES            YES            <- SYNC                ->   YES            YES
000/00000     000/00000     <- ES  15M/24H        ->   000/00000     000/00000
000/00000     000/00000     <- SES 15M/24H        ->   000/00000     000/00000
000/00000     000/00000     <- UAS 15M/24H        ->   000/00000     000/00000

LOOPBACKS INACTIVE           LOOPBACKS INACTIVE
HTU-C SIGNAL QUALITY        DSX-1                      DS1          HTU-R SIGNAL QUALITY
MIN[X]  9  [X]MIN          -----
[X]L  8  L[X]             ESF <- FRAME -> ESF      [X]L  8  L[X]
[X]O  7  O[X]             B8ZS <- CODE -> B8ZS    [X]O  7  O[X]
[X]P  6  P[X]             0-133 <- LB0 -> 0 dB    [X]O  6  O[X]
[X]  5  [X]             N/A <- NIU -> NO        [X]P  5  P[X]
[X]  4  [X]             00000 <- BPV -> 00000    [X]  4  [X]
[X]1  3  2[X]            00000 <- ES -> 00000    [X]1  3  2[X]
[X]  2  [X]             00000 <- SES -> 00000    [X]  2  [X]
[X]  1  [X]             00000 <- UAS -> 00000    [X]  1  [X]
[X]  0  [X]             NONE <- ALARMS -> NONE    [X]  0  [X]

Press "z" to zero registers, "x" to restart MIN/MAX, "M" for Main Menu,
"H" for HDSL Range Extender #1 (HRE) View.

```

Figure 8. Current System Status Screen

Type the letter “Z” at the Current System Status screen in order to reset the current performance registers to zero on both the Current System Status and Performance History screens. A prompt requires user confirmation to execute the zero registers function.

[Figures 8](#) and [9](#) consolidate current information for the HDSL, DSX-1, and DS1 interfaces. A key to the information provided is found in the center of the screen and defined in [Table 10](#) below. Arrows indicate the key applies to both the DDM+ HTU-C and HTU-R.

Table 10. HDSL, DS1, and DSX-1 Key Definitions

Indicator	Definition
LOSS	Pulse attenuation measurement ⁽¹⁾
SYNC	HDSL loop 1 and loop 2 sync status
ES 15M/24H	Errored seconds ⁽²⁾
SES 15M/24H	Severely errored seconds ⁽²⁾
UAS 15M/24H	Unavailable seconds ⁽²⁾

1. LOSS is typically several dB less than the insertion loss measured at 200 kHz. The LOSS measurement is a better indication of the loop’s attenuation of the 2B1Q signal than the insertion loss measured at a single frequency. ADTRAN HDSL can operate on cables with an excess of 30 dB LOSS.

2. The first number is for the current 15-minute period and the second is the current 24-hour period (Loop 1 and Loop 2 numbers are displayed).

An indication of Pair Reversal (if present) appears at the bottom of the first key column. Definitions for this key are provided in [Table 11](#). Status and configuration information for the DS1 and DSX-1 signals is located in the center of the screen near the bottom.

Table 11. Pair Reversal Key Definitions

Indicator	Definition
FRAME	T1 framing format selected
CODE	T1 line coded selected
LBO	Line build-out selected (for DSX-1), Customer signal of 0 or -15 dB (for DS1)
NIU	Network interface unit enabled
BPV	Bipolar violations detected (DSX-1 and DS1)
ES	Errored seconds (DSX-1 and DS1)
SES	Severely errored seconds (DSX-1 and DS1)
UAS	Unavailable seconds (DSX-1 and DS1)
Alarms	Lists current alarm condition status

A measure of signal quality for each HDSL loop appears on the bottom right and left of the screen. Guidelines for interpreting the measure indicators are given in [Table 12](#).

Table 12. HDSL Loop Signal Quality

Measure	Signal Quality	Noise Margin
0	Poor	≤ 0 dB ($\approx 10^{-7}$ BER)
1-8	Marginal	above 10^{-7} BER in dB
9	Excellent	≥ 9 dB above 10^{-7} BER

Predicting performance based upon signal quality varies with each loop. Generally, a noise margin of 0 or higher will support a bit error rate or better the 10^{-7} . ADTRAN defined guidelines that correspond to the operation of the DDM+ HTU-C faceplate LEDs labeled LP1 and LP2 are illustrated in [Table 13](#).

Table 13. ADTRAN Noise Margin Guidelines

Margin	LP1/LP2 LED	Loop Quality
Margin = 0	● Red	Poor Loop Quality
$0 < \text{Margin} < 4$	● Yellow	Marginal Loop Quality
Margin > 4	● Green	Good Loop Quality

Current System Status - HRE Screen

The Current System Status - HRE screen, illustrated in [Figure 9](#), is selected from the Current System Status screen by typing "H." Type "H" once to view current system status for HRE#1. Type "H" a second time to view current system status for HRE#2.

```

Circuit ID:HNTSVLALHDSL                                     MM/DD/YY hh:mm:ss
LOOP #1 <NETWORK> LOOP #2      CURRENT SYSTEM STATUS      LOOP #1 <CUSTOMER>LOOP #2
----- HRE #1 -----
27(27) dB          28(28) dB  <- LOSS CUR(MAX) ->  29(29) dB          29(29) dB
YES                YES      <- SYNC          ->      YES                YES
000/00000          000/00000  <- ES 15M/24H  ->  000/00000          000/00000
000/00000          000/00000  <- SES 15M/24H ->  000/00000          000/00000
000/00000          000/00000  <- UAS 15M/24H ->  000/00000          000/00000
      LOOPBACK INACTIVE                                LOOPBACK INACTIVE
HRE#1 NET SIGNAL QUALITY      N = NETWORK SIDE RECEIVER  HRE#1 CUST SIGNAL QUALITY
MIN[X] 9  [X]MIN              C = CUSTOMER SIDE RECEIVER  MIN[X] 9  [X]MIN
[X]L 8  L[X]
[X]O 7  O[X]
[X]O 6  O[X]
[X]P 5  P[X]
[X] 4  [X]
[X]1 3  2[X]
[X] 2  [X]
[X] 1  [X]
[X] 0  [X]
      Press "Z" to zero registers, "X" to restart MIN/MAX, "M" for Main Menu
      "P" for previous view, "H" for HDSL Range Extender #2 (HRE) view.

```

Figure 9. Current System Status - HRE Screen

Performance History Screen

The Performance History screen, illustrated in Figure 10, displays the historical HDSL and T1 performance data in several different registers. At each 15-minute interval, the performance information is transferred to the previous 15-minute performance data register. This DDM+ HTU-C stores performance data in 15-minute increments for the last 24-hour period. At each 24-hour interval, the performance data is transferred into the 24-hour performance data register also accessed from the Performance History screen.

Circuit ID:HNTSVLALHDSL			MM/DD/YY hh:mm:ss			
24 HOUR REGISTERS			PERFORMANCE HISTORY	15 MINUTE REGISTERS		
---ES---	---SES---	---UAS---		---ES---	---SES---	---UAS---
00000	00000	00000	<---CURRENT--->	000	000	000
12/31	-----	-----	<--	14:30	000	000 898 10:30 000 000 000
12/30	-----	-----		14:15	000	000 001 10:15 000 000 000
12/29	-----	-----		14:00	000	000 006 10:00 000 000 000
12/28	-----	-----		13:45	000	000 000 9:45 000 000 000
12/27	-----	-----	PREVIOUS	13:30	000	000 000 9:30 000 000 000
12/26	-----	-----		13:15	000	000 000 9:15 000 000 000
12/25	-----	-----	<--	13:00	000	000 000 9:00 000 000 000
				12:45	000	000 000 8:45 000 000 000
				12:30	000	000 000 8:30 000 000 000
				12:15	000	000 000 8:15 000 000 000
				12:00	000	000 000 8:00 000 000 000
				11:45	000	000 000 7:45 000 000 000
				11:30	000	000 000 7:30 000 000 000
				11:15	000	000 000 7:15 000 000 000
				11:00	000	000 000 7:00 000 000 000
				-->	10:45	000 000 000 6:45 000 000 000
VIEW 1 : HTU-C DSX-1						
1->	H -3---	H ----- H ---4- H -->				
	T	R R T				
	U	E E U				
<--	C -5---	1 ----- 2 ---6- R <-2				
Press view number to select view						
Press "H" to view HRE #1 history						
						Press "B" to go back 8 hours
						Press "M" to return to the Main Menu

Figure 10. Performance History Screen

Loopback Options Menu

The Loopback Options menu, illustrated in [Figure 12](#), displays and allows the changing of loopback settings throughout the HDSL circuit.

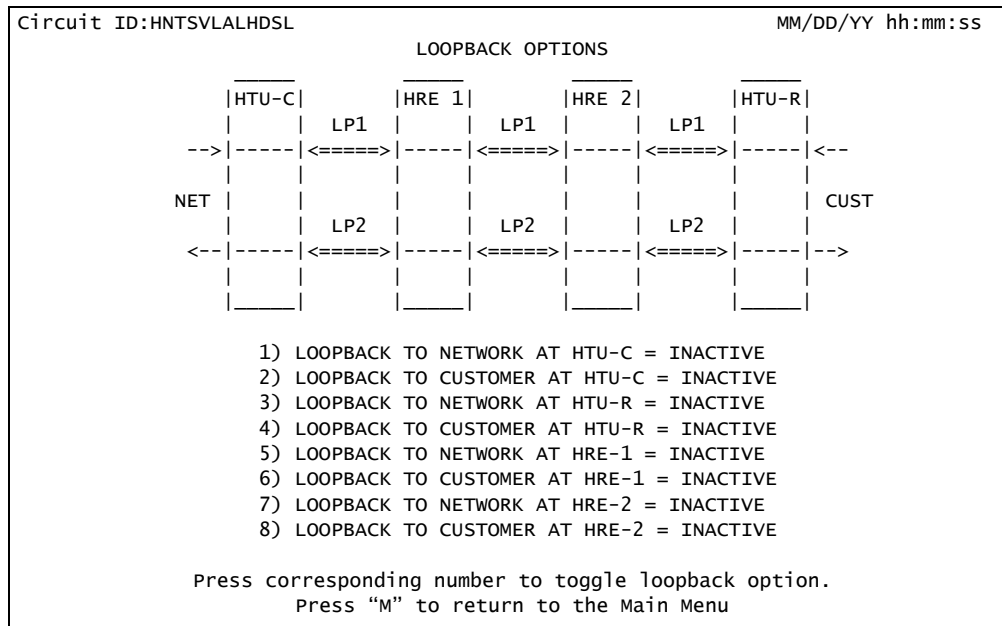

Figure 12. Loopback Options Screen

Self Test Options Screen

The Self Test Option screen, illustrated in [Figure 13](#), allows the initiation of self tests of the DDM+ HTU-C and HTU-R by typing “S.”

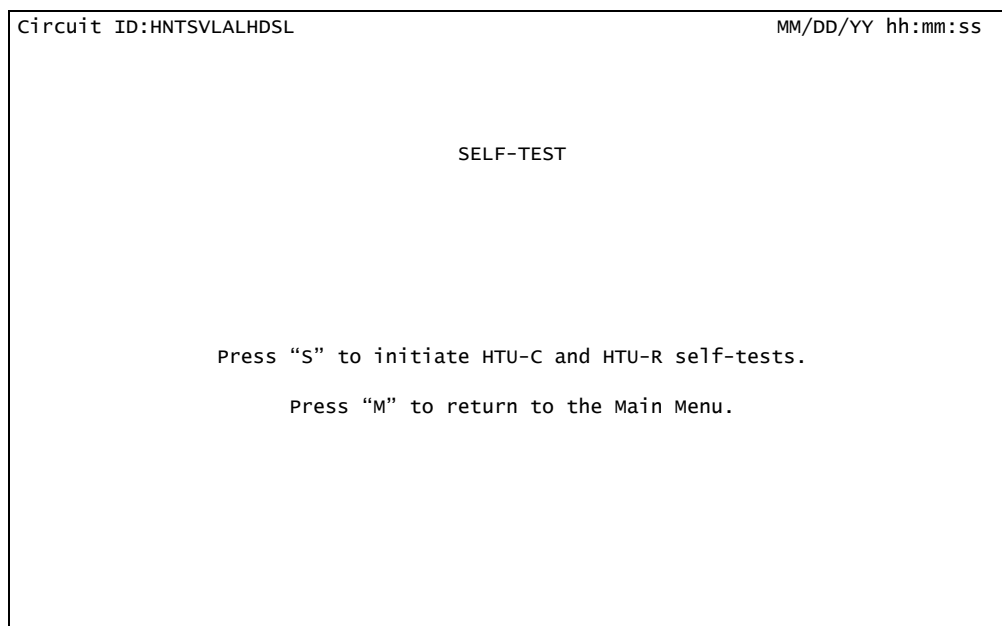

Figure 13. Self-Test Options Screen

Provisioning Menu

The Provisioning menu, illustrated in [Figure 14](#), provides the option to change the DDM+ HTU-C provisioning settings. A full list of provisioning options can be found in [Table 12](#).

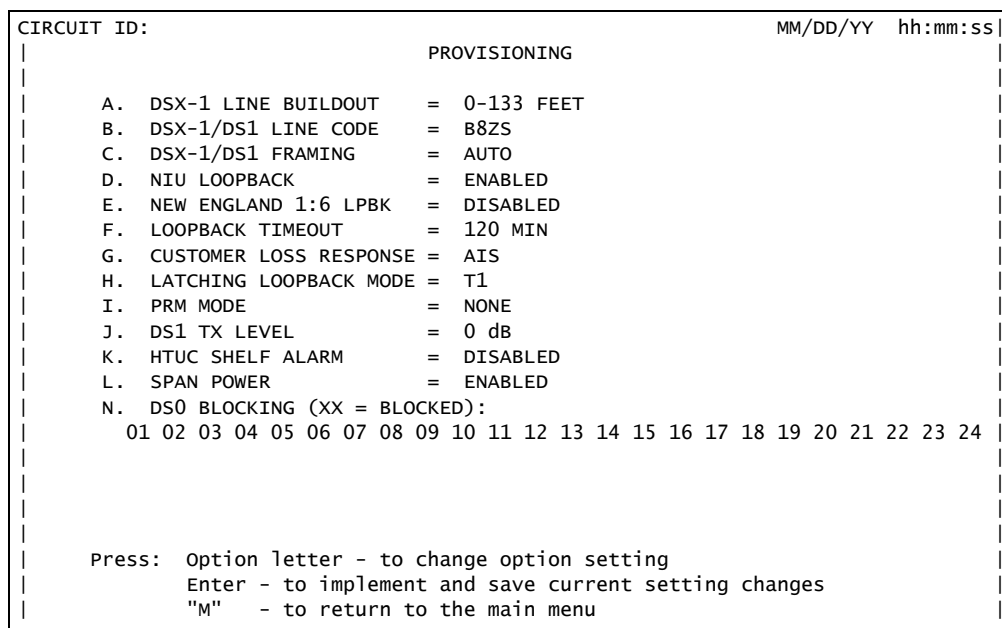

Figure 14. Provisioning Menu

Troubleshooting Display Screen

The Troubleshooting Display screen, illustrated in [Figure 15](#), graphically depicts an HDSL circuit. The DDM+ HTU-C reviews red, yellow, and blue alarm conditions in the circuit to automatically predict where a fault is located. Once a fault location is suspected, the corresponding portion of the circuit on the screen will be highlighted and a message describing the failure will appear.

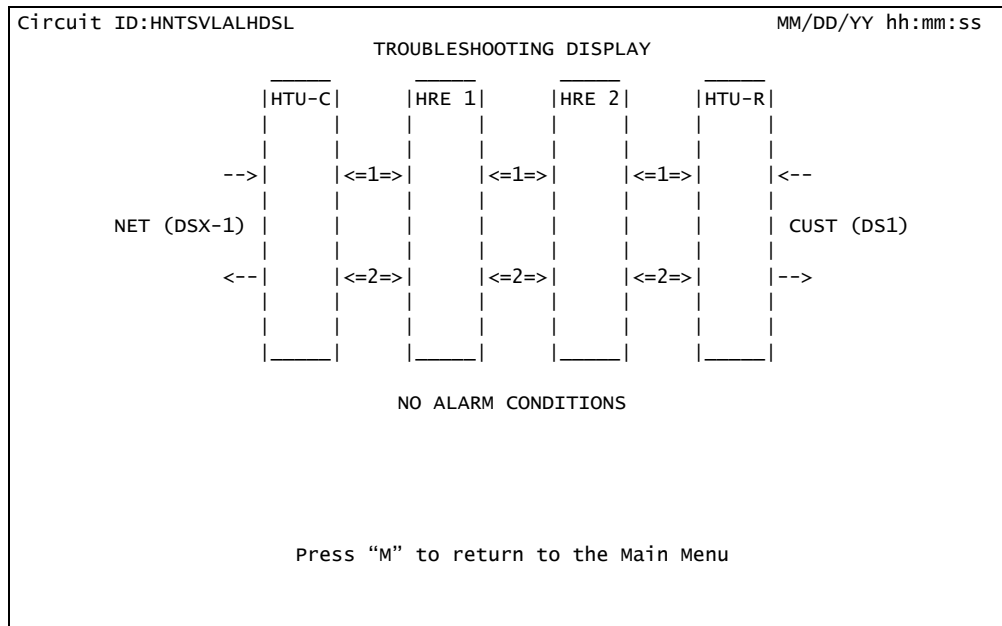

Figure 15. Troubleshooting Display Screen

Alarm History Screen

The Alarm History screen, illustrated in [Figure 16](#), provides detailed information on the alarm history of the HDSL and T1 spans. Information provided includes alarm location, type, first and last time/ date, current status, and count.

Circuit ID:HNTSVLALHDSL		T1 Alarm History		MM/DD/YY hh:mm:ss	
LOCATION	ALARM	FIRST	LAST	CURRENT	COUNT

HTU-C (DSX-1)	RED(LOS)			OK	000
	YELLOW			OK	000
	BLUE(AIS)			OK	000
HTU-R (DS1)	RED(LOS)			OK	000
	YELLOW			OK	000
	BLUE(AIS)			OK	000

HDSL Span History					

SPAN 1	LP1 HLOS			OK	000
	LP2 HLOS			OK	000
HTU-C	LP1 MRGN			OK	000
	LP2 MRGN			OK	000
HRE-1	LP1 MRGN			OK	000
	LP2 MRGN			OK	000

Press: C to clear history : H to scroll span alarms : M for main menu					

Figure 16. Alarm History Screen

Set Time/Date/Circuit ID Menu

The Set Time/Date/Circuit ID menu, illustrated in [Figure 17](#), provides additional provisioning options. Enter the time parameters as military time (for example, enter 3:15 p.m. as 15:15:00). Enter the date parameters in MM/DD/YY format. Enter the Circuit ID as a 25-character alphanumeric string.

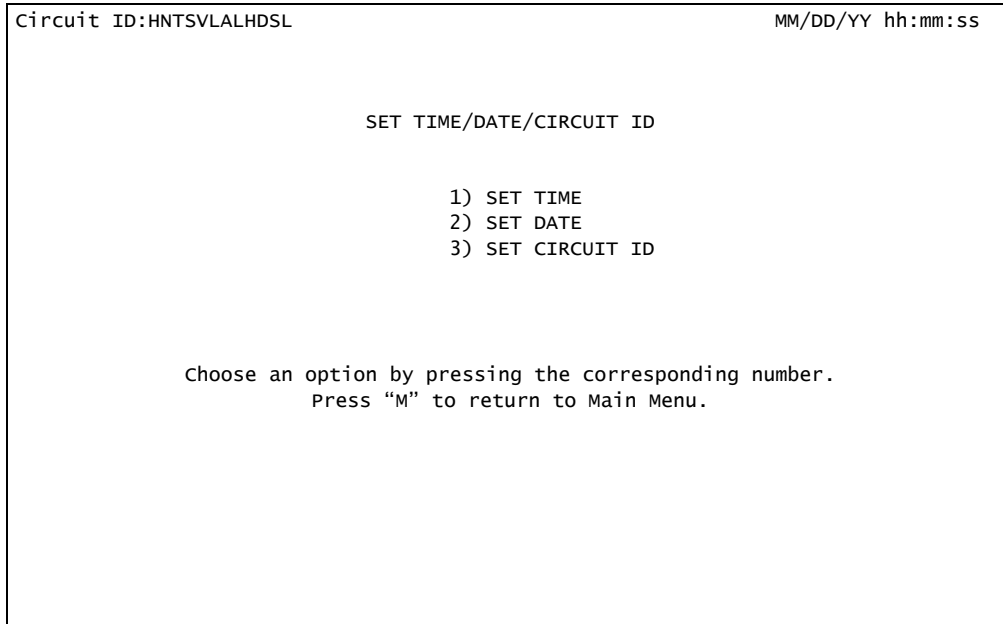

Figure 17. Set Time/Date/Circuit ID Screen

Default Options Screen

The Default Options screen, illustrated in [Figure 18](#), allows the setting of all provisioning options to the factory defaults.

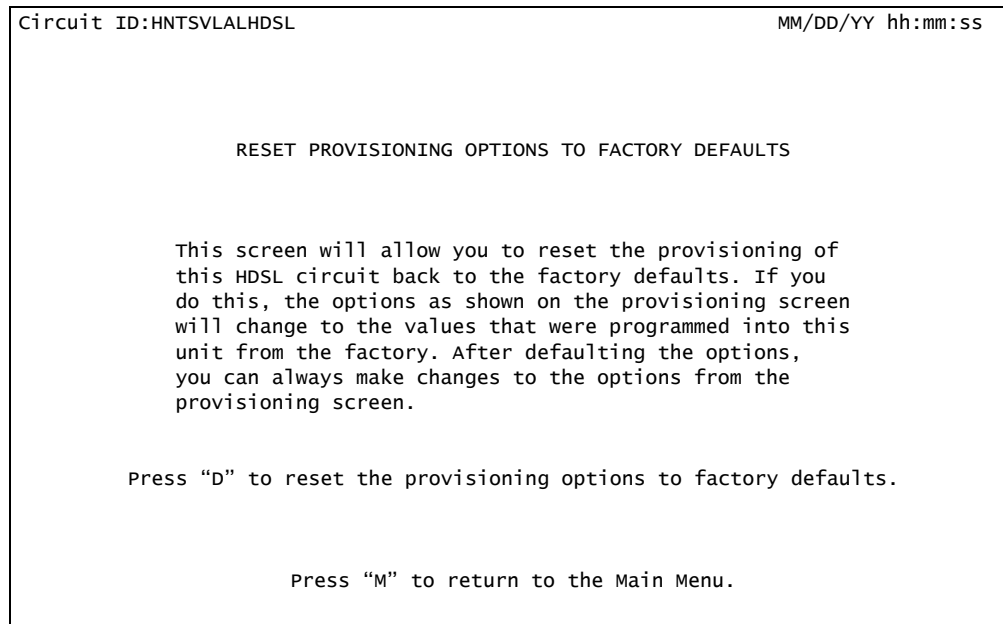

Figure 18. Default Options Screen

HDSL SYSTEM TESTING

The ADTRAN HDSL system provides extensive ability to monitor the status and performance of the DSX-1 signals, DS1 signals, and HDSL loop signals. Detailed performance monitoring is provided by the faceplate-mounted RS-232 Control Port. These features are valuable in troubleshooting and isolating any system level problems that may occur at installation or during operation of the HDSL system.

DDM+ HTU-C Bantam Jacks

The front panel of the DDM+ HTU-C contains metallic splitting bantam jacks for both non-intrusive (monitoring) and intrusive (terminating) DSX-1 test access.

DDM+ HTU-C Loopbacks

The DDM+ HTU-C responds to two different loopback activation processes. First, loopbacks may be commanded manually using the control port interface. [Table 12](#) depicts the Loopback Options Screen which provides for DDM+ HTU-C, HTU-R, and HRE loopbacks.

Second, the DDM+ HTU-C responds to the industry standard sequences for HDSL loopbacks. These loopback sequences are described in detail in [“Appendix A, HDSL Loopbacks”](#) of this practice.

The loopback condition imposed in both cases is a logic level loopback at the point within the DDM+ HTU-C where the DSX-1 signal passes into the HDSL modulators. [Figure 19](#) depicts all the loopback locations possible with ADTRAN HDSL equipment.

In addition to network-side loopbacks, the DDM+ HTU-C provides customer-side loopbacks initiated by using the terminal control port. In this mode, an AIS signal is supplied to the network. Customer-side loopbacks must be deactivated using the terminal.

NOTE

When the 11000 in-band code is used to loop the HTU-R, the HTU-R will re-enter armed state upon loopback timeout, or upon terminal deactivation. See Appendix A for a more detailed description of loopback element states.

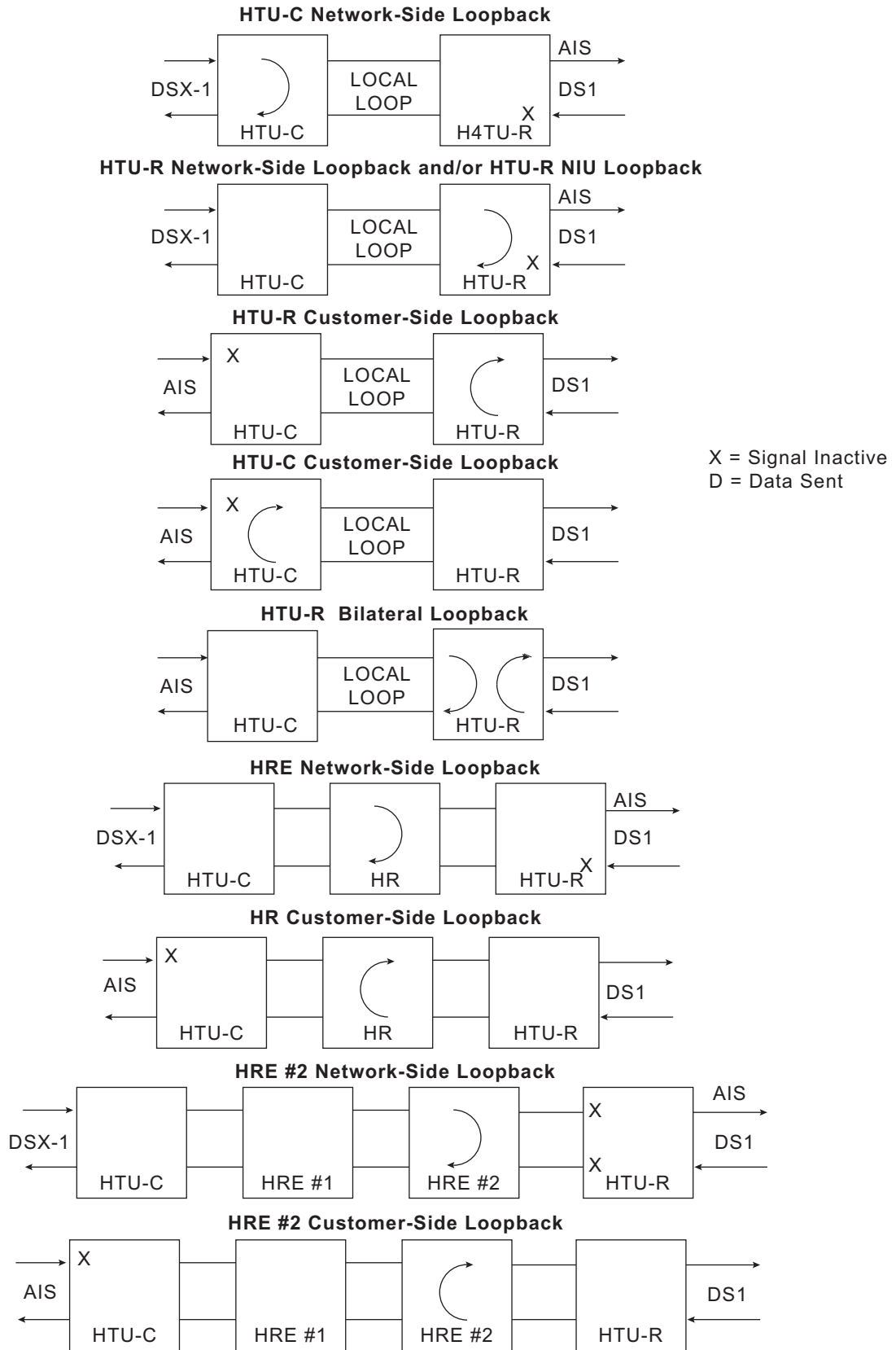

Figure 19. HDSL Loopbacks

TROUBLESHOOTING PROCEDURES

Table 15 is a troubleshooting guide for the ADTRAN DDM+ HTU-C.

Table 14. DDM+ HTU-C Troubleshooting Guide

Condition	Solution
Front panel indicator is <i>off</i> .	<ol style="list-style-type: none"> 1. Verify that -48 VDC power is properly connected to the shelf. 2. Inspect the fuse (F1) and verify that it is not blown. 3. Insert the DDM+ HTU-C into a slot known to be in good working condition; check to see if the STATUS indicator is on. 4. If Steps 1 and 2 pass, but Step 3 fails, replace the DDM+ HTU-C.

MAINTENANCE

The DDM+ HTU-C requires no routine maintenance. In case of equipment malfunction, use the faceplate-mounted DB9 RS-232 terminal interface to help in troubleshooting the source of the problem.

ADTRAN does not recommend that repairs be performed in the field. Repair services may be obtained by returning the defective DDM+ HTU-C to the ADTRAN Customer Service RMA Department.

SPECIFICATIONS

The DDM+ HTU-C specifications are detailed in [Table 15](#).

Table 15. DDM+ HTU-C Specifications

Specification	Description
Loop Interface:	
Modulation Type:	2B1Q
Mode:	Full Duplex; Echo Cancelling
Number of Pairs:	Two
Bit Rate:	784 kbps per pair
Baud Rate:	392 k baud per pair
Service Range:	Defined by CSA Guidelines
Loop Loss:	35 dB maximum at 196 kHz
Bridged Taps:	Single Taps < 2000 feet; Total Taps < 2500 feet
Performance:	Compliant with Bellcore TA-NWT-001210
HDSL Tx Signal Level:	13.5 dBm
Input Impedance:	135 watts
Return Loss:	20 dB (40 kHz to 200 kHz)
Network Interface:	
4-WIRE DSX-1	
DSX-1 Output Level:	0 dB
DSX-1 Line Build Out:	0–133 feet ABAM; 134–266 feet ABAM; 267–399 feet ABAM; 400–533 feet ABAM; 534–655 feet ABAM;
DSX-1 Line Code:	AMI B8ZS
DSX-1 Format:	SF; ESF; Unframed
DSX-1 Channelization:	Channels 1–12 on HDSL Loop 1; Channels 13–24 on HDSL Loop 2

Table 15. DDM+ HTU-C Specifications (Continued)

Specification	Description
Power:	
Tested with the ADTRAN HRE (P/N 1247045L1) and HTU-R (P/N 1247026L1)	
Total Power:	-48 VDC at 200 mA with HTU-R; -48 VDC at 330 mA with HTU-R and one HRE; -48 VDC at 560 mA with HTU-R and two HREs
DDM+ HTU-C Power Dissipation:	5.1 watts with HTU-R; 5.7 watts with one HRE and HTU-R 7.1 watts with two HREs and HTU-R
Span Power:	-190 VDC (internally generated): Class A2 compliant; Current limit at 150 mA
Fusing:	1.00 amp (on-board; not field replaceable)
Clock:	
Clock Sources:	Internal, DSX-1 Derived
Internal Clock Accuracy:	±25 ppm, (exceeds Stratum 4). Meets T1.101 timing requirements.
Tests:	
Diagnostics:	Self-Test;
Loopbacks:	<ul style="list-style-type: none"> • Local (HTU-C); • Remote (HTU-R); • HRE
Physical:	
23" DDM+ Shelf-Mounted	
Dimensions:	Height: 3.51 inches; Width: 0.71 inches; Depth: 9.89 inches
Weight:	Less than 1 pound
Environment:	
Temperature:	Operating (Standard): -40°C to +70°C; Storage: -40°C to +85°C
Control Port:	
Interface:	RS-232 (DB9)
Terminal Type:	VT 100 or compatible
Async Speed:	2.4 kbps to 19.2 kbps
Data Format:	8 data bits, no parity, 1 stop bit
Part Number:	
DDM+ HTU-C:	1247003L1

Appendix A

HDSL Loopbacks

HDSL MAINTENANCE MODES

This Appendix describes operation of the HDSL system with regard to detection of in-band and ESF facility data link loopback codes. The operation of the loopback commands in the ADTRAN HDSL system is compliant with the recommendation to ANSI recorded in T1E1.4/92. The HDSL network loopback points described below are shown in [Figure A-1](#).

DDM+ HTU-C Loopback

A regenerative loopback of the DSX-1 signal toward the network.

HTU-R Loopback

A regenerative loopback of the DS1 signal toward the network. This loopback is in addition to a separate Smartjack loopback. Separate activation sequences are provided for the HTU-R and the Smartjack loopback initiation.

HRE Loopback

A regenerative loopback of the HDSL signal toward the network.

Upon deactivation of a loopback, the HDSL system will synchronize automatically. Note that the synchronization process of the HDSL system upon deactivation of the HRE loopback could take up to 15 seconds, ensuring all system elements are synchronized.

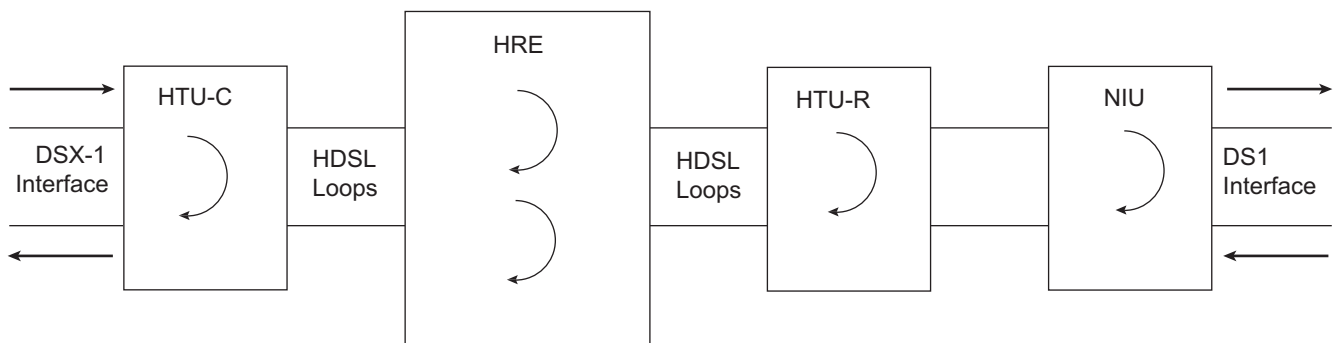

Figure A-1. HDSL Loopback Points

Loopback Process Description

In general, the loopback process for the HDSL system elements is modeled on the corresponding DS1 system process. Specifically, the DDM+ HTU-C loopback is similar to an Intelligent Office Repeater loopback and the HTU-R loopbacks are similar to an inline T1 Repeater loopback.

Each HDSL system element is independently described by the state diagram shown in [Figure A-2](#). The four states are disarmed, loop-up, armed, and loop-up/time-out disable.

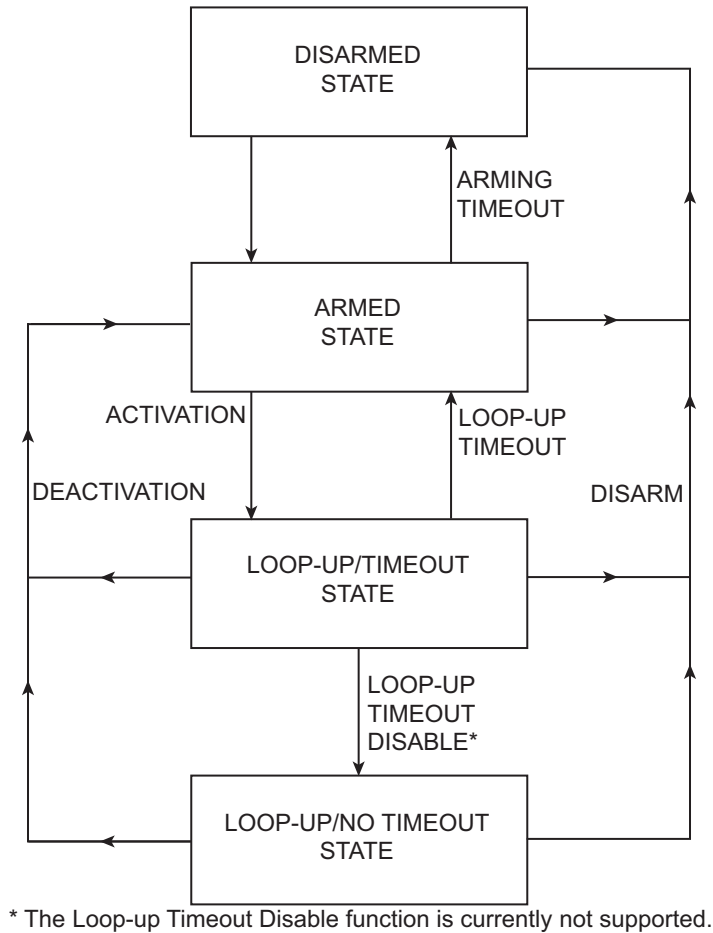

Figure A-2. HDSL Element State Diagram

State transitions result from in-band and ESF Data Link sequences as well as timeout operations. The sequences and timeout values are as follows:

- Arming Sequence (in-band and ESF)
- Activation Sequence
- Deactivation Sequence
- Disarming Sequence (in-band and ESF)
- Loop-up Timeout
- Arming Timeout

In-band control code sequences are transmitted over the DS1 link by either the unframed or overwrite method. The HDSL elements respond to either method.

The unframed method produces periodic control sequences and the normal DS1 framing bit is omitted.

The overwrite method produces periodic control sequences. However, once per frame, the framing bit overwrites one of the bits in the control sequence.

The unit can detect the loopback activation or deactivation code sequence only if an error rate of 1E-03 or better is present.

HDSL Loopback Codes

A summary of HDSL loopback codes are given in [Table A-1](#).

Table A-1. HDSL Loopback Control Codes

Function	Code (Binary/Hex)	Response
Arming (In-band)	11000	Signal sent in-band or over ESF data link.
Arming (ESF)	1111 1111 0100 1000	HDSL elements in disarmed state make transition to armed state. Detection of either code results in Smartjack loop up, if NIU loopback is enabled.
Activation (HTU-C)	1101 0011 1101 0011	Signal sent in-band. HDSL elements in armed state make transition to loop up state. Loop up state time out is programmable from the HTU-C. Sends 231 bit errors every 20 seconds.
Arm Source: Network	100000 (1 in 6)	Signal sent in-band. HDSL elements in disarmed state transition to armed state. Detection of the code results in an HTUR network loopback if New England Loopback (NELB) is enabled.
Disarming (In-band)	11100	Signal sent in-band. HDSL elements loopdown and transition to disarmed state.
Disarming (ESF)	1111 1111 0010 0100	Signal sent in the FDL. HDSL elements loopdown and transition to disarmed state.
Deactivation	1001 0011 1001 0011	Signal sent in-band. HDSL elements loopdown and transition to disarmed state. If NIU is enabled, the HTU-R will not loopdown.
Disarm Source: Network or Customer	100 (1 in 3)	Signal sent in-band. HDSL elements loopdown and transition to disarmed state.
Activation (HTU-C) Source: Network	1111 1111 0001 1110/ FF1E	Signal sent in-band. HTU-C loops back the T1 data to the network equipment.
Activation (HTU-C) Source: Network	1111000 (4 in 7)	Signal sent in-band. HTU-C loops back the T1 data to the network equipment.

Table A-1. HDSL Loopback Control Codes (Continued)

Function	Code (Binary/Hex)	Response
Activation (HTU-C) Source: Customer	1111110 (6 in 7)	Signal sent in-band. HTU-C loops back the T1 data to the customer equipment.
Activation (HTU-C) Source: Customer	0111 1111 0001 1110/ 3F1E	Signal sent in-band. HTU-C loops back the T1 data to the customer equipment.
Activation (HTU-R) Source: Network	1111 1111 0000 0010/ FF02	Signal sent in-band. HTU-R loops back the T1 data to the network equipment.
Activation (HTU-R) Source: Network	1110000 (3 in 7)	Signal sent in-band. HTU-R loops back the T1 data to the network equipment.
Activation (HTU-R) Source: Customer	1111100 (5 in 7)	Signal sent in-band. HTU-R loops back the T1 data to the customer equipment.
Activation (HTU-R) Source: Customer	0111 1111 0000 0010/ 3F02	Signal sent in-band. HTU-R loops back the T1 data to the customer equipment.
Activation (HTU-R) Source: Network or Customer	1100 0111 0100 0011/ C742	Signal sent in-band. HTU-R loops back the T1 data to the source direction. Sends 20 bit errors every 10 seconds.
Activation (HRE-1) Source: Network or Customer	1100 0111 0100 0001/ C741	Signal sent in-band. HRE-1 loops back the T1 data to the source direction. Sends 10 bit errors every 20 seconds.
Activation (HRE-2) Source: Network or Customer	1100 0111 0101 0100/ C754	Signal sent in-band. HRE-2 loops back the T1 data to the source direction. Sends 200 bit errors every 20 seconds.
Query (All Elements) Source: Network	1101 0101 1101 0101/ D5D5	Signal sent in-band. Any unit that is in network loopback injects bit errors into the data looped to the network equipment. The element closest to the network that is in loopback injects the errors. <ul style="list-style-type: none"> • HTU-C that is in a network loopback injects 231 bit errors every 20 seconds. • HTU-R that is in a network loopback injects 20 bit errors every 10 seconds. • HRE-1 that is in a network loopback injects 10 bit errors every 20 seconds. • HRE-2 that is in a network loopback injects 200 bit errors every 20 seconds.
Disable Loopback Timeout Source: Network	1101011011010101/ D5D6	Signal sent in-band. Loopback Timeout is disabled as long as any element is in loopback or armed.
Disable Span Power Source: Network	0110011101100111/ 6767	Signal sent in-band. Span power is disabled until this pattern is removed.

Appendix B

DS0 Blocking

ADTRAN has implemented the DS0 blocking feature enabling the HDSL system to remain transparent to customer data. This allows ADTRAN products to comply with the transparency requirements of Bellcore TA-NWT-001210. However, when the circuit is provisioned for ESF operation, this transparency results in a condition described below.

If a customer of a Fractional T1 service fills any of the unused DS0 channels with information other than an all 1s idle code, the ADTRAN HDSL system will block this information from reaching the remote end of the circuit. This forces information in those DS0 channels to be an all 1s idle code.

The result of this blocking is that the CRC checksum delivered to the remote end will not match the checksum calculated by the remote T1 CSU. This implies errors are being made on the loop when actually the blocking function created the CRC errors. Enabled DS0 channels pass error-free.

In order to avoid this condition, Fractional T1 customers are encouraged to fill the unused timeslots with an idle code. This is a common capability on Fractional T1 CSU/DSU, D4 channel banks, and other CPE devices capable of connecting to Fractional T1 service.

This page is intentionally blank.

Appendix C

Shelf Configuration

DDM PLUS SHELF POPULATION (POWER REQUIREMENTS)

1. Determine shelf fusing (A) _____ Amps
Typically: 20 Amp for DDM+ shelf (10 amp per side)
 2. Divide (A) by 2 to provide 100% over current protection (B) _____ Amps
 3. Determine the mix of HDSL circuits.
 - Percentage of circuits without an HRE in the circuit (C) _____ Percent
 - Percentage of circuits with one HRE in the circuit (D) _____ Percent
 - Percentage of circuits with two HREs in the circuit (E) _____ Percent
 4. Determine current draw of HDSL circuits.
 - Multiply (C) by 0.155 Amps (without an HRE) (F) _____ Amps/Unit
 - Multiply (D) by 0.276 Amps (with an HRE) (G) _____ Amps/Unit
 - Multiply (E) by 0.421 Amps (with two HREs) (H) _____ Amps/Unit
 5. Add (F) through (H) to get total current draw (I) _____ Amps/Unit
 6. Divide (B) by (I) to get the number of Units per shelf _____ Units/Shelf *
- * DDM+ Shelf is physically limited to only 28 units per shelf.

This page is intentionally blank.

Appendix D

Warranty

WARRANTY AND CUSTOMER SERVICE

ADTRAN will replace or repair this product within the warranty period if it does not meet its published specifications or fails while in service. Warranty information can be found at www.adtran.com/warranty.

Refer to the following subsections for sales, support, Customer and Product Service (CAPS) requests, or further information.

ADTRAN Sales

Pricing/Availability:

800-827-0807

ADTRAN Technical Support

Pre-Sales Applications/Post-Sales Technical Assistance:

800-726-8663

Standard hours: Monday - Friday, 7 a.m. - 7 p.m. CST

Emergency hours: 7 days/week, 24 hours/day

ADTRAN Repair/CAPS

Return for Repair/Upgrade:

(256) 963-8722

Repair and Return Address

Contact CAPS prior to returning equipment to ADTRAN.

ADTRAN, Inc.

CAPS Department

901 Explorer Boulevard

Huntsville, Alabama 35806-2807



Carrier Networks Division
901 Explorer Blvd.
Huntsville, AL 35806