

## Express 6530 SHDSL NxNTU Installation and Maintenance

### CONTENTS

1. GENERAL .....	1
2. CONNECTIONS .....	4
3. OPTIONING .....	7
4. SPECIFICATIONS .....	18
5. WARRANTY AND CUSTOMER SERVICE .....	19

### FIGURES

Figure 1. Express 6530 SHDSL NxNTU .....	1
Figure 2. Express 6530 Functional Overview .....	2
Figure 3. Express 6530 Back Panel .....	4
Figure 4. Express 6530 Strap Map .....	7
Figure 5. Express 6530 Menu Tree .....	8
Figure 6. Cross-Connect Map .....	9
Figure 7. Time Slot Allocation .....	10
Figure 8. Framed Full E1 Service .....	11
Figure 9. Unframed Full E1 Service .....	11
Figure 10. Full Nx64K 2 Mbps Service .....	12
Figure 11. Back-to-Back NTU Operation .....	12
Figure 12. Local Dual Sided Loopback .....	13
Figure 13. Remote Dual Sided Loopback .....	13
Figure 14. Local Customer Transparent Loopback .....	14
Figure 15. Remote Customer Transparent Loopback .....	14
Figure 16. Local Customer Nontransparent Loopback .....	14
Figure 17. Remote Customer Nontransparent Loopback .....	14
Figure 18. Local Network Transparent Loopback .....	14
Figure 19. Remote Network Transparent Loopback .....	14
Figure 20. Local Network Nontransparent Loopback .....	14
Figure 21. Remote Network Nontransparent Loopback .....	14
Figure 22. CRC-4 Detection/Generation .....	16

### TABLES

Table 1. LED Descriptions .....	2
Table 2. Front Panel Pushbuttons .....	3
Table 3. SHDSL Pin Connections .....	4
Table 4. G.703 Pin Connections .....	4
Table 5. V.28 Pin Connections .....	5
Table 6. X.21 Pin Connections .....	5
Table 7. V.35 Pin Connections .....	6
Table 8. V.36 Pin Connections .....	6
Table 9. Loopback Overview .....	15
Table 10. Express 6530 SHDSL NxNTU Specifications .....	18

## 1. GENERAL

This practice contains installation and maintenance information for the Express 6530 SHDSL NxNTU, P/N 1225001L1. The unit is illustrated in **Figure 1**. The ADTRAN Express 6530 is a network terminating unit using Single-Pair High Speed Digital Subscriber

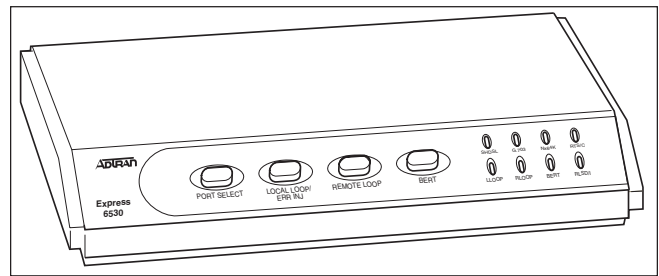
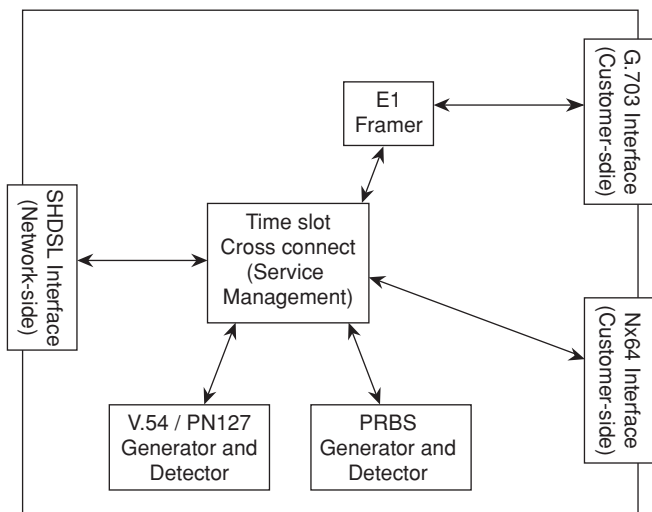

**Figure 1. Express 6530 SHDSL NxNTU**

Line (SHDSL) technology to transport data over a single copper loop. The Express 6530 interfaces between the incoming ITU G.991.2 (SHDSL) leased-line service and the customer's Data Terminal Equipment (DTE), providing solutions for LAN-to-LAN bridging, Frame Relay, and/or PBX termination.

The Express 6530 is a locally powered standalone unit which contains an integrated Data Service Unit (DSU), eliminating the need for a separate DSU. The Express 6530 interfaces to a customer's G.703, V.35, or X.21 interfaces and can be provisioned to support simultaneous G.703 and Nx64 services. The SHDSL interface is designed to operate from 192 kbps to 2.304 Mbps in 64 kbps increments or from 3 to 36 time slots, with each time slot representing 64 kbps. The SHDSL time slots can be multiplexed to the G.703 and/or the Nx64 interfaces. The maximum number of time slots that can be directed toward the G.703 interface is 32 (2.048 Mbps), while the Nx64 can support 36 (2.304 Mbps). A block diagram of the Express 6530 functionality is illustrated in **Figure 2**.

The Express 6530 can be deployed in pairs for a local campus application or to an LTU located in a Central Office. The Express 6530 can be locally or remotely provisioned with local provisioning being accomplished through the V.28 control port using a dumb terminal or PC with a terminal emulation program. The Express 6530 can be remotely provisioned by another Express 6530 or an ADTRAN SHDSL LTU. The Express 6530 can initiate and respond to local and remote loopbacks and has an internal  $2^{15}-1$  pseudorandom test pattern for bit error testing. Front panel mounted LEDs and pushbuttons provide interface and test status as well as the initiation of a remote or local loopback.



**Figure 2. Express 6530 Functional Overview**

The Express 6530 can be powered from any AC power source ranging from 90 V to 240 V at frequencies of 50 Hz to 60 Hz, or a nominal -48 VDC power source.

The SHDSL NTU will be used to provide access to customer premises to E1 or Nx64K leased-line services, as well as primary-rate ISDN. The SHDSL NTU is required to support leased-line G.703/G.704 and/or Nx64K services to customers. The primary applications will include connection to routers and PABXs.

### Front Panel Features

The Express 6530 unit has eight front panel LEDs. **Table 1** lists and describes these front panel LEDs.

**Table 1. LED Descriptions**

LED	Status	Description
SHDSL	<i>Off</i> <i>Green</i> <i>Amber</i> <i>Red</i>	Main Power off Trained with good signal quality Trained with marginal signal quality Training or attempting to train with poor signal quality and/or a major network port alarm is active
G.703	<i>Off</i> <i>Green</i> <i>Amber</i> <i>Red</i>	Service not configured Service configured and interface is operating normally Service is configured and has minor alarms: RAI; Slip; CRC-4 errors; LBER (10E-6 BER) Service configured and interface is not operating normally: LOS; AIS; LOA; HBER (10E-3 BER)
Nx64K	<i>Off</i> <i>Green</i> <i>Red</i>	Service not configured Service configured and interface is operating normally Service configured and interface is not operating normally due to alarms present, DTR Off, or cabling problem
RTS/C	<i>Off</i> <i>Green</i>	Nx64K service not configured or RTS/C control line is OFF RTS/C control line (from DTE) is ON
RLSD/I	<i>Off</i> <i>Green</i>	Nx64K service not configured or RLSD/I control line is OFF RLSD/I control line (from DCE) is ON
LLOOP	<i>Off</i> <i>Amber</i> <i>Red</i>	No loop present A local loop is active on the selected port (activated from any source) A local loop is active on one or more ports or G.703 services; no port selected (activated from any source)
RLOOP	<i>Off</i> <i>Amber</i> <i>Red</i>	No loop present A remote loop is active on the selected port (activated from any source) A remote loop is active on one or more ports or G.703 services; no port selected (activated from any source)
BERT	<i>Off</i> <i>Green</i> <i>Amber</i> <i>Red</i>	No BERT BERT OK; pattern synchronized BERT bit errors BERT; pattern not synchronized

The Express 6530 has four front panel pushbuttons. The buttons are protected from accidental operation. The front panel button functions can be disabled via the management interface. It is possible to disable the port select SHDSL option to avoid the possibility of looping the SHDSL port when disabled. **Table 2** lists and describes these four pushbuttons.

The “Port Select” button operates in the following manner:

1. When no port has been selected (indicated by none of the port LEDs flashing), then only the “Port Select” button is enabled and the LL, RL and BERT LEDs are an ordered summation of the test states of the Nx64K, G.703 and SHDSL interfaces.
2. The Port Select button cycles through the following ports on each successive press:
  - Nx64K
  - G.703
  - SHDSL (only if enabled via the EOC)
  - No Selection
3. When the Nx64K port is selected, the Nx64K LED will flash as an indication. The Local Loop/Err Inj, Remote Loop and BERT buttons will initiate/terminate tests and the corresponding LEDs indicates the status of tests on this port only.

4. When the G.703 port is selected, the G.703 port LED flashes as an indication.

If there is only a single service on the G.703 port then the Local Loop/Err Inj, Remote Loop and BERT buttons initiate/terminate tests and the corresponding LEDs indicate the status of tests on this port only.

If there are multiple services, the G.703 port Local Loop/Err Inj, Remote Loop, and BERT buttons are disabled, and the corresponding LEDs indicate the status of tests on this port only (initiated from sources other than the front panel buttons).

5. When the SHDSL port is selected, the SHDSL port LED flashes as an indication. Note that the SHDSL port select can only occur if enabled via the management interface. The Local Loop/Err Inj, Remote Loop, and BERT buttons will initiate/terminate tests and the corresponding LEDs indicate the status of tests on this port only. These tests are on the aggregate SHDSL payload

Port Select will not operate if any locally initiated tests are in progress.

**Table 2. Front Panel Pushbuttons**

Button Label	Description
PORT SELECT	On each successive press, cycles through the following: Nx64K, G.703, SHDSL, and No Select.
LOCAL LOOP/ ERR INJ	If a port is selected, and a BERT is not in progress then pressing the button will initiate/terminate a local loopback test on the selected port. If a BERT is in progress, then pressing the button injects a single bit error.
REMOTE LOOP	If the SHDSL port is selected, then pressing the button will initiate/terminate a remote loopback test on the port by sending a request message to the remote unit. If the Nx64K port or G.703 port (with only one service defined) is selected, then pressing the button will initiate/terminate a remote loopback test on the selected port's single data service by sending in-band loop up/down patterns to the far end.
BERT	If a port is selected and there are no local loopback tests active, then pressing the button will start or stop a BERT on the selected port.

## 2. CONNECTIONS

### Back Panel Features

The back panel of the Express 6530 SHDSL NxNTU is illustrated in **Figure 3**.

The SHDSL port uses a RJ-45 connector with the interchange circuits and pinouts listed in **Table 3**.

The 120 ohm balanced G.703 port uses a RJ-45 connector with the pinouts defined in **Table 4**. The G.703 port supports a 2048 Kbps port using a 120 ohm balanced interface that conforms to ITU-T G.703 Section 9.

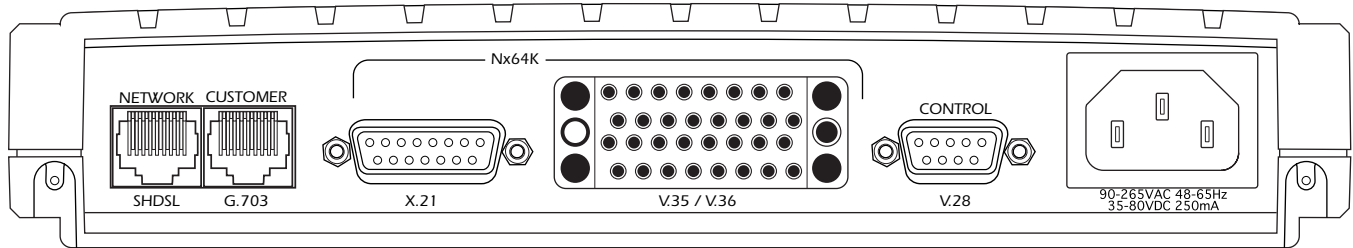

**Figure 3. Express 6530 Back Panel**

**Table 3. SHDSL Pin Connections**

Interchange Name	Description	Pinout
N/C	No Connection	1,2,3
tip	SHDSL tip	4
ring	SHDSL ring	5
N/C	No Connection	6,7,8

**Table 4. G.703 Pin Connections**

Pin	Function
1	Receive pair (ring)
2	Receive pair (tip)
3	Receive shield
4	Transmit pair (ring)
5	Transmit pair (tip)
6	Transmit shield
7	NC
8	NC

The local management port is a DB-9 female connector and is labeled V.28. The interchange circuits and pinouts are listed in **Table 5**. The local management baud rate will auto-detect between 2400 baud and 57600 baud.

See EIA-574, Sec 2.2 and Figure 2.7, with Receive Data, Transmit Data and Signal Ground only. The other pins are internally connected to ensure correct handshaking interoperability. These internal connections shall be made via resistor traces to facilitate with future build options.

**Table 6** defines the X.21 port pin connections.

**Table 5. V.28 Pin Connections**

Interchange Name	Description	Pinout
DCD	Data Carrier Detect - Internally connected to DTR and DSR	1
RXD	Receive Data	2
TXD	Transmit Data	3
DTR	Data Terminal Ready - Internally connected to DCD and DSR	4
GND	Signal Ground	5
DSR	Data Set Ready - Internally connected to DCD and DTR	6
RTS	Ready To Send - Internally connected to CTS	7
CTS	Clear To Send - Internally connected to RTS	8
NC	No Connection	9

**Table 6. X.21 Pin Connections**

Circuit Number	Circuit Name	To/From DCE	Pinout (A/B)
G	Signal Ground		8
Ga	DTE Common Return		15
T	Transmit	FROM	2/9
R	Receive	TO	4/11
C	Control	FROM	3/10
I	Indication	FROM	5/12
S	Signal Element Timing		6/13
X	DTE Signal Element Timing	TO	7/14
	Shield Ground Option		1

**Table 7** defines the V.35 port pin connections.

**Table 8** defines the V.36 port pin connections.

**Table 7. V.35 Pin Connections**

Circuit Number	Circuit Name	To/From DCE	Pinout (A/B)
102	Signal Ground		B
102-3	Transmit Data	TO	P/S
104	Receive Data	FROM	R/T
105	Request to Send	TO	C
106	Clear to Send	FROM	D
107	Data Set Ready	FROM	E
108/2	Data Terminal Ready	TO	H
109	Received Line Signal Detect	FROM	F
113	Transmit Signal Element Timing	TO	U/W
114	Transmit Signal Element Timing	FROM	Y/AA
115	Receive Signal Element Timing		V/X
140	Remote Loopback	TO	N
141	Local Loopback	TO	L
142	Test Indicator	FROM	NN

**Table 8. V.36 Pin Connections**

Circuit Number	Circuit Name	To/From DCE	Pinout (A/B)
102, 102a, 102b	Signal Ground		19, 37, 20
103	Transmit Data	TO	4/22
104	Receive Data	FROM	6/24
105	Request to Send	TO	7/25
106	Clear to Send	FROM	9/27
107	Data Set Ready	FROM	11/29
108/2	Data Terminal Ready	TO	12/30
109	Received Line Signal Detect	FROM	13/31
113	Transmit Signal Element Timing	TO	17/35
114	Transmit Signal Element Timing	FROM	5/23
115	Receive Signal Element Timing	FROM	8/26
140	Remote Loopback	TO	14
141	Local Loopback	TO	10
142	Test Indicator	FROM	18

### 3. OPTIONING

#### Hardware Optioning

The strap map for the Express 6530 SHDSL NxNTU is illustrated in **Figure 4**.

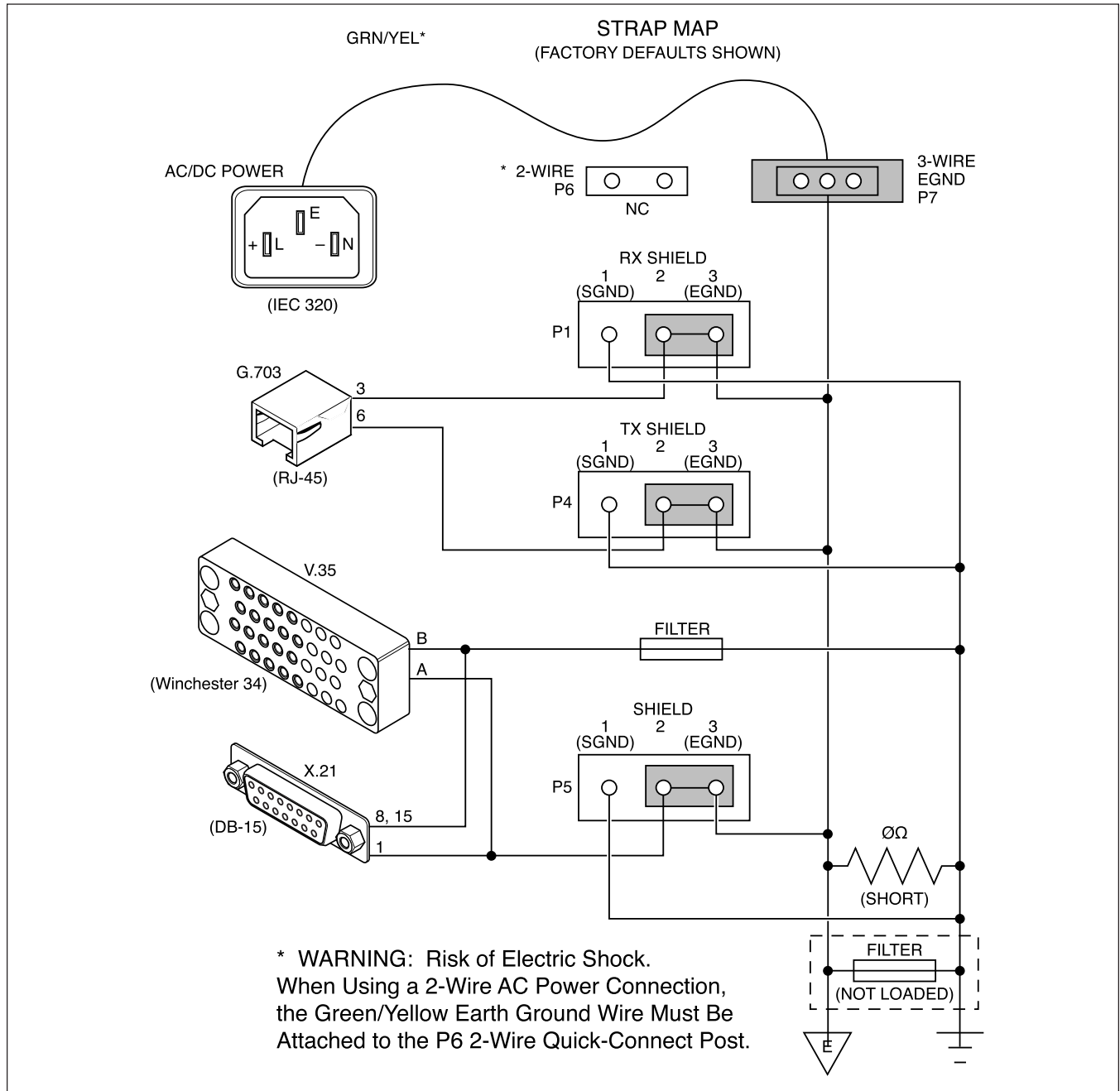

**Figure 4. Express 6530 Strap Map**

# Software Optioning

The menu tree in **Figure 5** illustrates the path to every provisioning, performance monitoring, and test access point in the Express 6530 menu system.

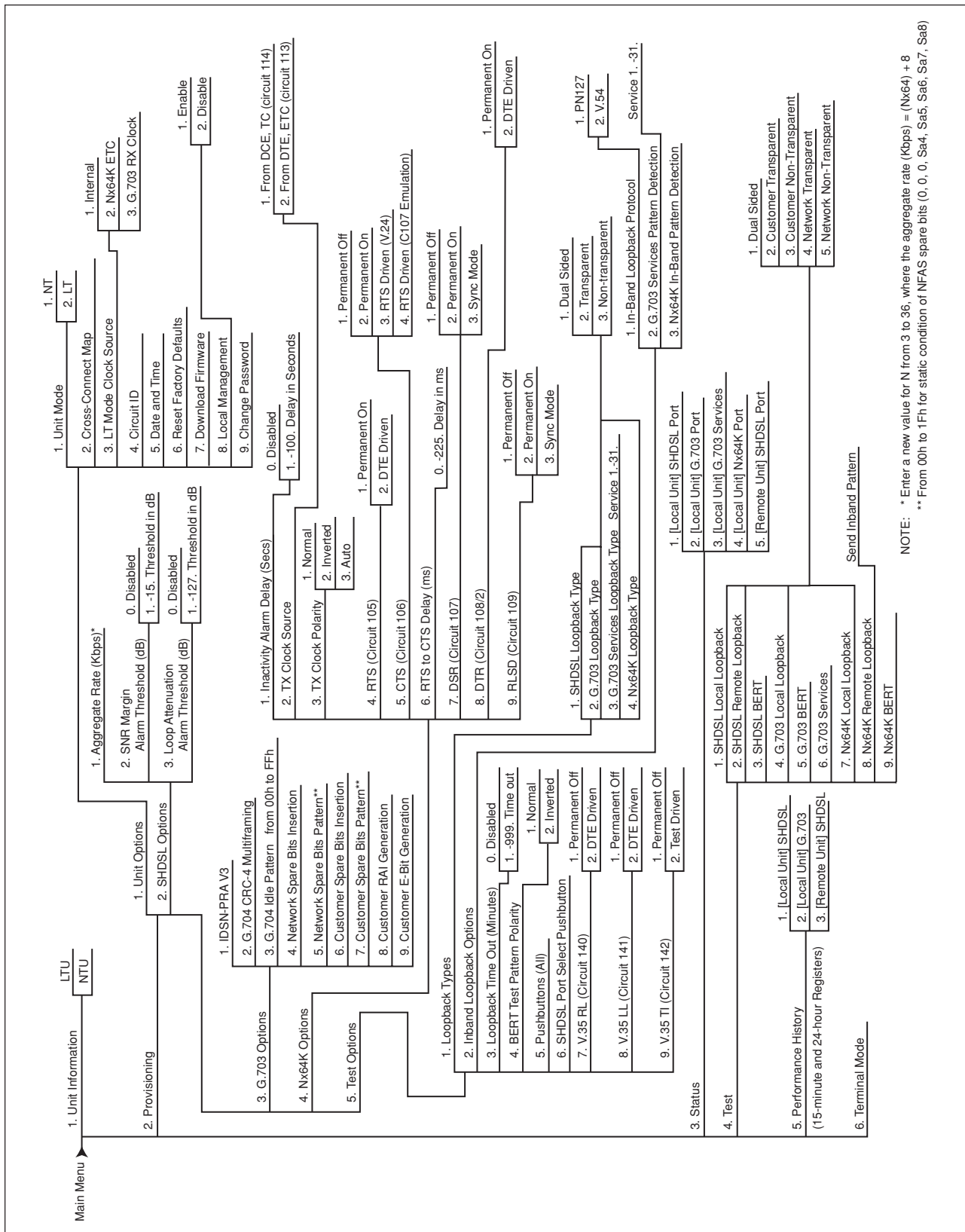

**Figure 5. Express 6530 Menu Tree**



## Cross-Connect Map

The purpose of the cross-connect map is to allocate the time slots (TS0s) from the SHDSL loop to user ports (E1, V.35/X.21) and configure framing. The cross-connect maps can be accessed via the VT100 terminal screens. Select “1,” *Provisioning*, from the Main Menu. Choose to provision the local unit (Selection 1) or the remote unit (Selection 2). Next, select “1,” *Unit Options*, and then “3,” *Cross Connect Map*. The cross-connect map is shown in **Figure 6**.

The cross-connect map is split down the middle in two sections. The left section of the map lists the SHDSL time slots and right section of the map lists the G.703 time slots. The user builds a new pending map before making it active with the apply key. The options listed at the bottom of the screen allow the user to setup and manipulate the time slots. The statement under the list of commands indicates the framing status. Time slot configuration options are defined as follows:

### 0. Idle

If a time slot is set for idle, an idle code is inserted. The pattern will always be FF hex (all 1s) toward the SHDSL network.

The idle pattern out the G.703 interface is programmable under the G.703 option. The default is value FF hex (all 1’s).

### 1. - 31. G.703 Service

The selected time slot will carry G.703 service (Refer to the *Full G.703 Services* subsection for more information).

### 32. G.704 Framing

This option enables three different framing configurations. Framing is always set in the first time slot (TS0). The framing will be locally generated if 32 is entered in the G.703 TS0 slot only. If 32 is entered in the G.703 TS0 and the SHDSL TS0, then the framing will be passed transparently between the G.703 and SHDSL ports. If values other than 32 are assigned to both the SHDSL TS0 slot and G.703 TS0 slot then the operation is G.703 unframed (if other G.703 service values are assigned to the G.703 time slots).

### 33. Nx64K Service

The selected time slot will carry Nx64K service. The value assignment is only valid for the SHDSL time slots.

### A. Apply New Map

This command saves and activates any changes made by the user.

### U. Undo New Map

This command will undo any changes made by the user since the last saved configuration. The new pending map will revert to the currently active time slot assignments.

```

Circuit ID:                                01-Jan-00 22:03:22
Unit Mode: NT                               Provisioning Type: Local

                                Cross-Connect Map
                                SHDSL Timeslots      G.703 Timeslots
TS0 = 32   TS12 = 1   TS24 = 1   TS0 = 32   TS12 = 1   TS24 = 1
TS1 = 1    TS13 = 1   TS25 = 1   TS1 = 1    TS13 = 1   TS25 = 1
TS2 = 1    TS14 = 1   TS26 = 1   TS2 = 1    TS14 = 1   TS26 = 1
TS3 = 1    TS15 = 1   TS27 = 1   TS3 = 1    TS15 = 1   TS27 = 1
TS4 = 1    TS16 = 1   TS28 = 1   TS4 = 1    TS16 = 1   TS28 = 1
TS5 = 1    TS17 = 1   TS29 = 1   TS5 = 1    TS17 = 1   TS29 = 1
TS6 = 1    TS18 = 1   TS30 = 1   TS6 = 1    TS18 = 1   TS30 = 1
TS7 = 1    TS19 = 1   TS31 = 1   TS7 = 1    TS19 = 1   TS31 = 1
TS8 = 1    TS20 = 1   TS32 = N/A TS8 = 1    TS20 = 1
TS9 = 1    TS21 = 1   TS33 = N/A TS9 = 1    TS21 = 1
TS10 = 1   TS22 = 1   TS34 = N/A TS10 = 1   TS22 = 1
TS11 = 1   TS23 = 1   TS35 = N/A TS11 = 1   TS23 = 1

Timeslot Assignments                Commands
0. Idle                             A. Apply New Map   G. Full G.703 Service
1.-31. G.703 Service 1-31           U. Undo New Map   N. Full Nx64K Service
32. G.704 Frame                     Tab. Select SHDSL or G.703 Timeslots
33. Nx64K Service                   Arrow Keys. Move Cursor

                                G.704 Framing = LT Delivered
  
```

**Figure 6. Cross-Connect Map**

### G. Full G.703 Service

If this quick key command is selected, the cross-connect map will automatically configure the time slots for Full G.703 service, and the framing will be set for transparent. Refer to the *Typical Applications* subsection for more information.

### N. Full Nx64K Service

If this quick key command is selected, the cross-connect map will automatically configure the time slots for full Nx64K service. Refer to the *Typical Applications* subsection for more information.

### Tab. Select SHDSL or G.703 Timeslots

The tab key moves the cursor between the SHDSL and G.703 sections of the cross-connect map.

### Arrow Keys. Move Cursor

The arrow keys allow movement between the individual time slots.

### G.703 Service Time Slots

A service is comprised of an arbitrary collection of time slots from the SHDSL interface that shall be configured via the management interface. Time slot allocation on an ordered noncontiguous basis is possible with each time slot within a service having the same delay. An example is illustrated in **Figure 7**.

All unused time slots contain a configurable bit pattern that is set via the management interface. The default bit pattern is all 1s. Unused time slots are those which are sent out of the G.703 port, but are not part of a service. The G.703 port transmits the unused time slot patterns, and the receive ignores the unused time slots.

The service values (1-31) correlate to the G.703 Services test options. These options provide the capability to loopback and test time slots by service value, so as not to affect other services in surrounding time slots.

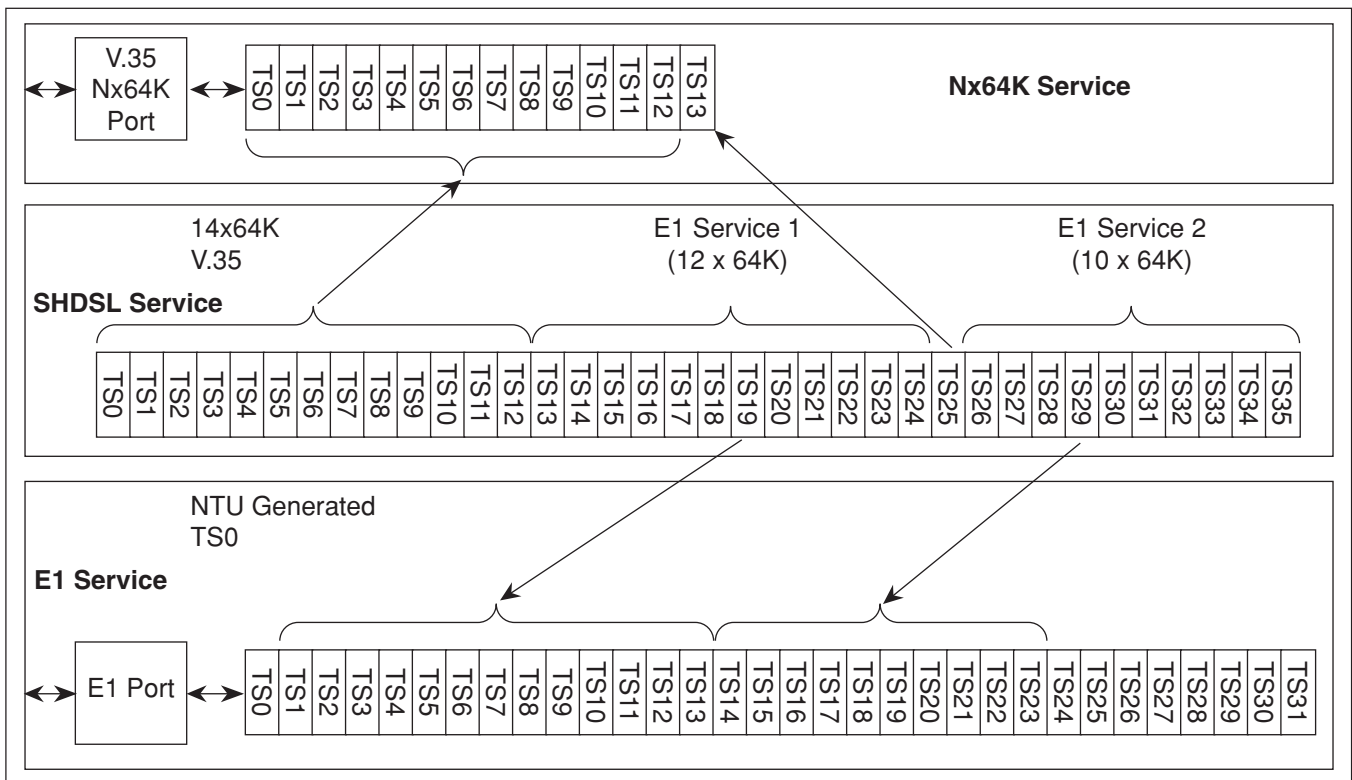
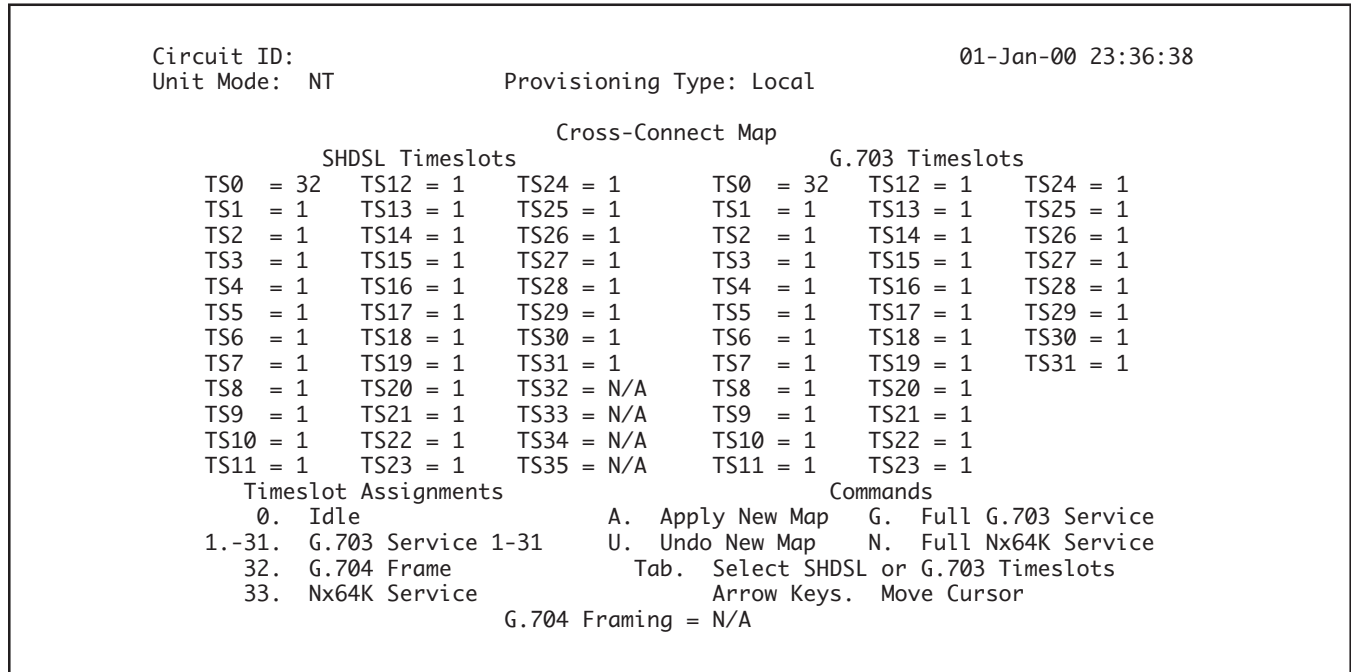

**Figure 7. Time Slot Allocation**

## Typical Applications

Framed Full E1 Service is set up using the quick key “G,” and then selecting “A” to save the changes. The screen in **Figure 8** illustrates a cross-connect map configured for Framed Full E1 Service.

Unframed Full E1 Service is set up using the quick key “G,” entering “1” in both the SHDSL TS0 slot and the G.703 TS0 slot, and then selecting “A” to save the changes. The screen in **Figure 9** illustrates a cross-connect map configured for Unframed Full E1 Service.



**Figure 8. Framed Full E1 Service**

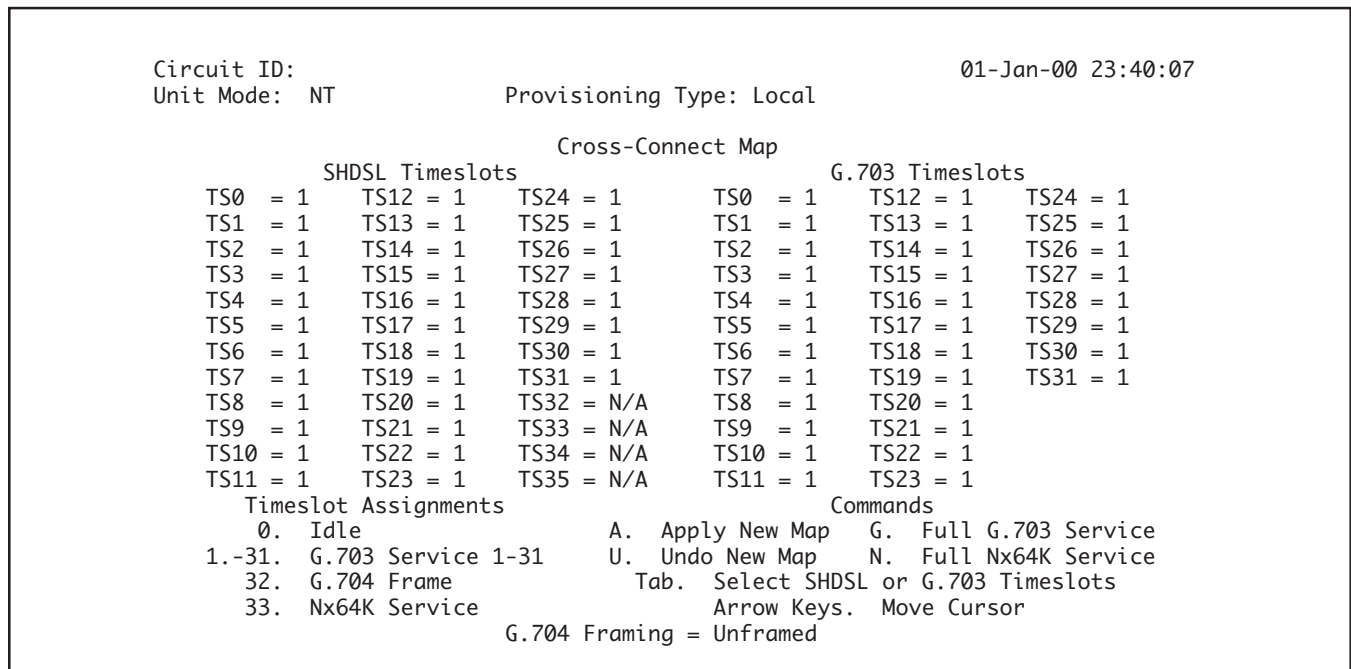

**Figure 9. Unframed Full E1 Service**

Full Nx64K 2 Mbps Service is set up using the quick key “N,” and then selecting “A” to save the changes. The screen in **Figure 10** illustrates a cross-connect map configured for Full Nx64K 2 Mbps Service.

In addition, when setting up Full Nx64K 2 Mbps Service, the type of line interface must be specified. V.35, V.36, or X.21 may be selected. To reach this portion of the menu, select “2,” *Provisioning*, from the main menu, and choose the local or the remote unit provisioning. Select “4,” *Nx64K Options*, and then select “2,” *Interface Type Manual Select*. Finally, enter the desired line interface.

### Back-to-Back NTU Operation

The NTU supports back-to-back operation (**Figure 11**)

1. One NTU must be configured as the NT (STU-R)
2. The other NTU must be configured as the LT (STU-C)

The STU-C and STU-R modes are selected via the local management port only. The default mode for the NxNTU is STU-R.

#### NOTE

For the LT (STU-C), Network and Customer direction are opposite of ITU G.991.2 specification definitions. In a back-to-back configuration, the “Network” direction is always toward the SHDSL port and the “Customer” direction is always away from the SHDSL port

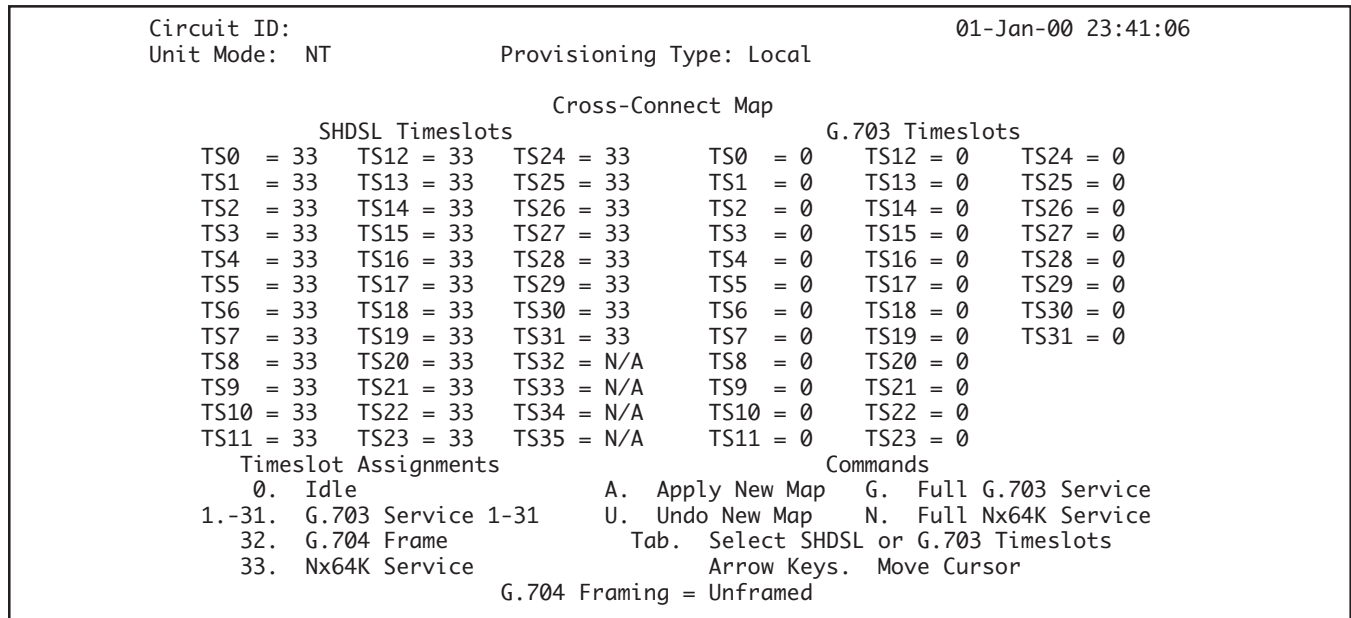

**Figure 10. Full Nx64K 2 Mbps Service**

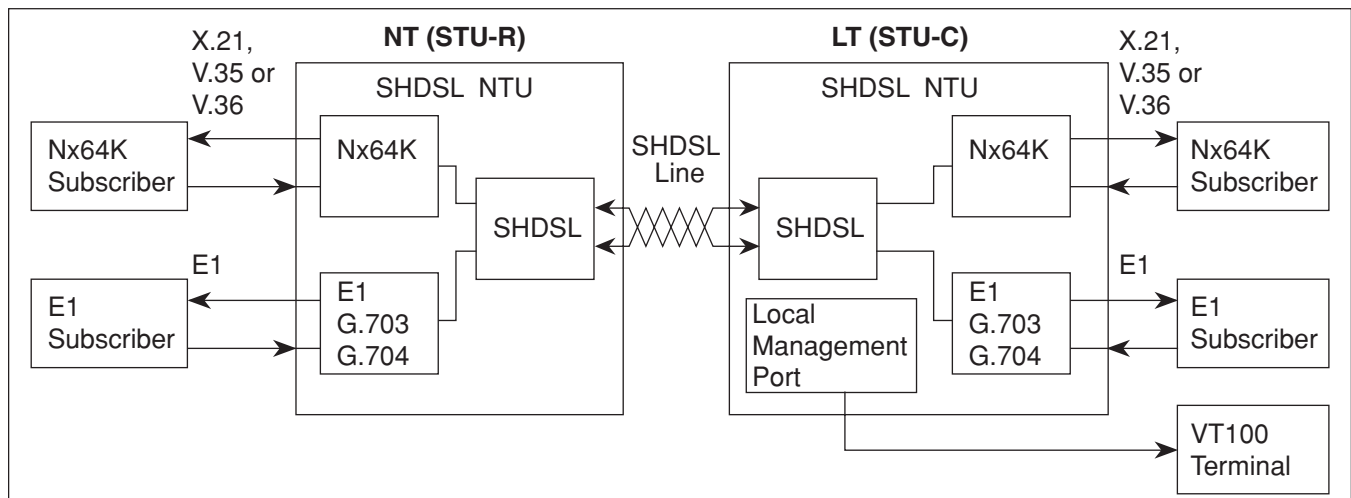

**Figure 11. Back-to-Back NTU Operation**

### Bit Error Rate Test

The SHDSL NTU contains a built-in Bit Error Rate Test (BERT). The BERT involves injecting and detecting a Pseudorandom Binary Sequence (PRBS) toward the network on the selected payload (i.e. G.703, Nx64, or entire SHDSL payload). The PRBS used in the SHDSL NTU is PRS15 as defined in ITU-T O.150 and O.151. It is also known as a 2e-15 pattern.

The BERT is only accessible via the VT100 terminal screens. Select “4. Test” from the Main Menu Screen. From the Test Screen, the SHDSL BERT, G.703 BERT, and Nx64K BERT options will appear, and each has one of the following status messages:

**N/A** – This BERT is currently unavailable. Only one BERT can be active at a time. For example, if SHDSL BERT is active, all others will be N/A.

**ACTIVE** – This BERT is currently in progress. The source column identifies the person who initiated the BERT.

**INACTIVE** – This BERT is not currently in progress. After selecting a BERT type from the Test Screen, the BERT Screen will appear, illustrating both BERT statistics and commands.

If no BERT is currently active, the following list of commands will be available:

**Start** – Starts the BERT on the selected port/service.

If the BERT is currently active, the following list of commands will be available:

**Stop** – Stops the BERT in progress.

**Inject a Single Bit Error** – Injects one bit error into the pattern.

**Restart** – Clears out all statistics and restarts the BERT.

In addition to the commands, the following statistical information is provided:

**Bit Error Rate** – Total number of bit errors divided by the total number of bits in the current test interval.

**Bit Error Count** – Total number of bit errors in the current test interval.

**Pattern Sync Loss Count** – Total number of times that the BERT has lost pattern sync.

**Errored Seconds** – Total number of seconds in which at least one bit error has occurred.

**Total Elapsed Time** – Total time that has elapsed since the test began (Days: Hours: Minutes: Seconds).

A BERT status field supplies the following information:

**On** – The BERT has started and has pattern sync.

**Searching for pattern** – The BERT has lost pattern sync.

**Off** – This BERT is currently off.

### Loopbacks

There are five types of local loopbacks and five types of remote loopbacks available for each of the three line interfaces (V.35, G.703, and SHDSL). When initiating a loopback, the first step is choosing a line interface. When V.35 is chosen, the loopback will occur at the V.35 drivers and receivers. When G.703 is chosen, the loopback will occur at the G.703 drivers and receivers. When SHDSL is chosen, the loopback will occur at the SHDSL drivers and receivers.

---

#### NOTE

All remote loopbacks are initiated at the local Express 6530 unit.

---

**Local Dual Sided Loopback** – Provides a bidirectional loopback at the NTU (**Figure 12**).

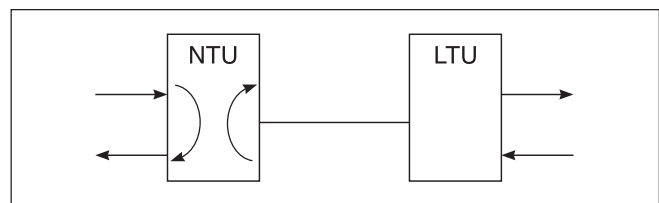

**Figure 12. Local Dual Sided Loopback**

**Remote Dual Sided Loopback** – Initiated at the NTU and provides bidirectional loopback at the LTU (**Figure 13**).

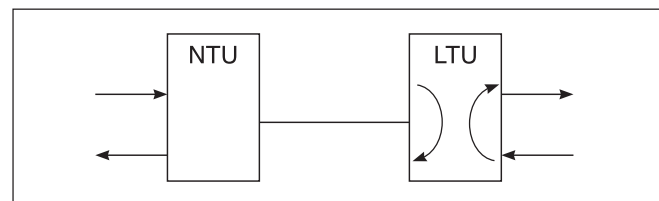

**Figure 13. Remote Dual Sided Loopback**

**Local Customer Transparent Loopback** – Provides a loopback at the NTU in the customer direction (**Figure 14**). Data is passed transparently to the network side.

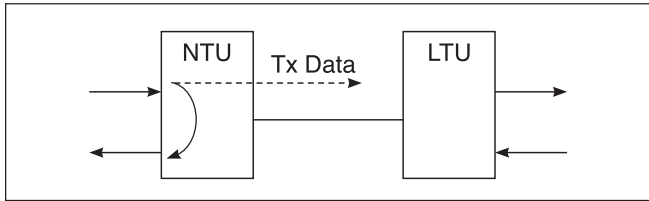

**Figure 14. Local Customer Transparent Loopback**

**Remote Customer Transparent Loopback** – Initiated at the NTU and provides a loopback at the LTU in the customer direction (**Figure 15**). Data is passed transparently to the network side.

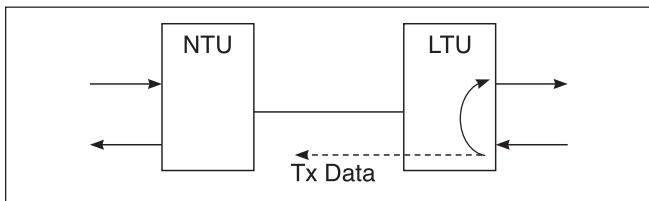

**Figure 15. Remote Customer Transparent Loopback**

**Local Customer Nontransparent Loopback** – Provides a loopback at the NTU in the customer direction (**Figure 16**). AIS signal is injected into the network side.

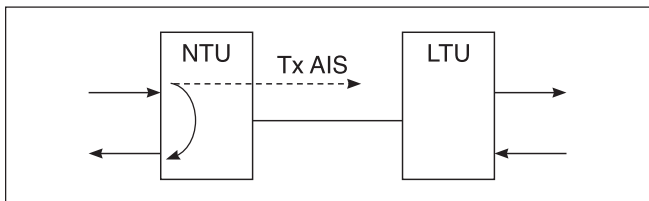

**Figure 16. Local Customer Nontransparent Loopback**

**Remote Customer Nontransparent Loopback** – Initiated at the NTU and provides a loopback at the LTU in the customer direction (**Figure 17**). AIS signal is injected into the network side.

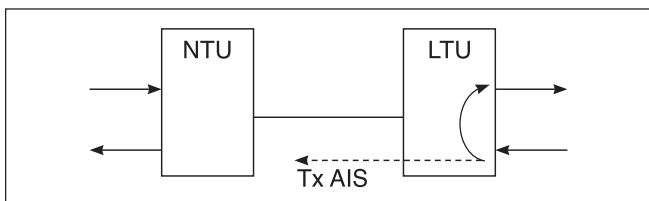

**Figure 17. Remote Customer Nontransparent Loopback**

**Local Network Transparent Loopback** – Provides a loopback at the NTU in the network direction (**Figure 18**). Data is passed transparently to the customer side.

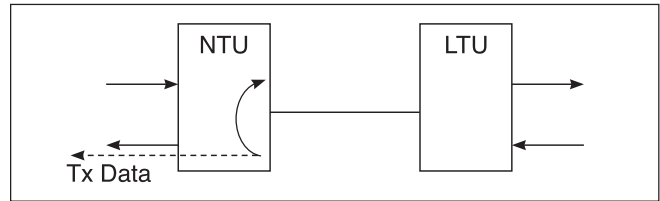

**Figure 18. Local Network Transparent Loopback**

**Remote Network Transparent Loopback** – Initiated at the NTU and provides a loopback at the LTU in the network direction (**Figure 19**). Data is passed transparently to the customer side.

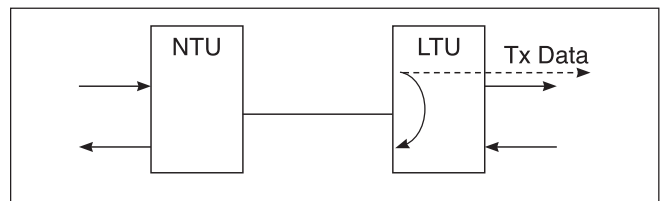

**Figure 19. Remote Network Transparent Loopback**

**Local Network Nontransparent Loopback** – Provides a loopback at the NTU in the network direction (**Figure 20**). AIS signal is injected into the customer side.

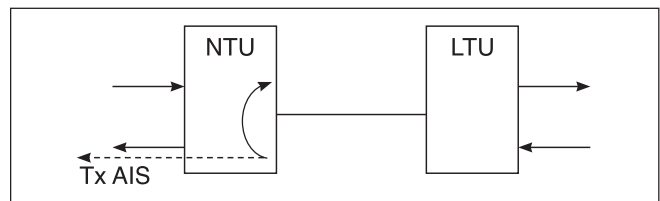

**Figure 20. Local Network Nontransparent Loopback**

**Local Network Nontransparent Loopback** – Initiated at the NTU and provides a loopback at the LTU in the network direction (**Figure 21**). AIS signal is injected into the customer side.

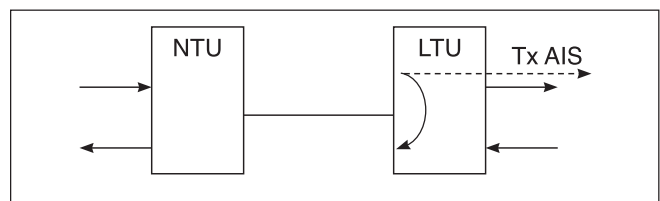

**Figure 21. Remote Network Nontransparent Loopback**

Loopbacks may be initiated via the VT100 test screens, front panel pushbuttons, Nx64K port control leads, or by receiving V.54 or PN127 in-band looping signals. Not all loopback types are available for all

ports and port services by all initiating sources. See **Table 9** for an overview. A key to the symbols displayed in the Table 9 is available below the Table.

**Table 9. Loopback Overview**

Initiating Source	Ports			Services	
	Customer, away from SHDSL Port (left)	Network, toward SHDSL Port (right)	SHDSL Port	G.704 Service	Nx64K Service
<b>VT100 Test Screens</b>					
<b>VT100 Loopback On</b> (Initiates one of five loopback types, regardless of the associated Loopback Type Option setting.)*					(Same as Nx64K Port)
<b>VT100 Loopback Off</b>					
<b>LL Button On</b> (Initiates a Local Customer Loopback per the selected port Loopback Type Option setting)					Single service only (Same as Nx64K Port)
<b>LL Button Off</b>					
<b>RL Button On</b> (Initiates a Remote Network Loopback per the remote unit's selected port Loopback Type Option setting)*	Sends In-Band Patterns	N/A	Sends EOC Request Message	Single service only	(Same as Nx64K Port)
<b>RL Button Off</b>	Sends In-Band Patterns		Sends EOC Request Message	Sends In-Band Patterns	
<b>Nx64K Port Control Leads</b>					
<b>C141 LL On</b> (Initiates a Local Customer Loopback per the Nx64K port Loopback Type Option setting)		N/A	N/A	N/A	(Same as Nx64K Port)
<b>C141 LL Off</b>		N/A	N/A	N/A	
<b>C140 RL On</b> (Initiates a Remote Network Loopback per the remote unit Nx64K port Loopback Type Option setting)*	Sends In-Band Patterns	N/A	N/A	N/A	(Same as Nx64K Port)
<b>C140 RL Off</b>		N/A	N/A	N/A	
<b>In-band Looping Protocol Reception</b>					
<b>Receive In-band Preparatory Signal</b> (Applies the loopback after detection of in-band V.54 or PN127 remote looping pattern per the associated service Loopback Type Option setting)	(Same as Nx64K Service)	N/A	N/A		
<b>Receive In-band Termination Signal</b> (Terminates loopback after detection of in-band V.54 or PN127 remote looping pattern)		N/A	N/A		

**Key:** Dual Loop    Transparent Loop    Nontransparent Loop    No Loop

\* The reception of in-band loopback patterns and EOC loopback request messages may be ignored or blocked on certain SHDSL LTUs installed in Total Access 3000 Systems

## Multiple Services

The NTU supports the configuration of multiple services. These services are routed to either the G.703/G.704 interface or the Nx64K interface. The Nx64K interface supports a single service with  $1 \leq N \leq 36$ . The G.703 interface (with G.704 framing) supports multiple services (often termed “Stacked E1”). The G.703 interface without any framing supports a single 2048 kBit/s service. (See ITU-T G991.2 Annex. E.1-TPS-TC for European 2048 kbit/s digital Unstructured Leased Line (D2048U).)

The Nx64K service and G.703 service are capable of operating simultaneously. The total number of time slots must be less than or equal to the maximum number of SHDSL time slots (excluding TS0 if structured E1 is used). The G.703 interface with framing (G.704) runs over SHDSL in aligned mode and supports simultaneous services using the Nx64K port for the second service. (See ITU-T G991-2 Annex E.7 - TPS-TC for Aligned European 2048 kbit/s digital Structured Leased Line (D2048S) and Fractional.)

The SHDSL NTU supports CRC-4 detection/generation toward the SHDSL network (**Figure 22**). The CRC-4 detection/generation can operate in the following modes (configurable via the management interface):

1. CRC-4 detection/generation disabled
2. CRC-4 detection/generation enabled

When less than 32 time slots are configured on the G.703 port, the NTU bases the CRC-4 detection/generation on filling the unused time slots with a fixed pattern configurable via the management interface. This CRC-4 detection/generation is also required for multi-rate (single or simultaneous services) where less than 31 G.704 time slots are carried over the SHDSL line.

### NOTE

All framed services operate in aligned mode.

## Operation

The SHDSL NTU supports multiple rate line operation as specified in ITU-T G.991.2. All services described in this document operate in multiple rate mode, with a corresponding change in maximum payload. Unstructured E1 is supported for SHDSL rates equal to 32 and with all G.703 time slot assignments equal to the same G.703 service value (1 to 31).

The G.703 interface supports operation in the following modes that are selectable via the management interface:

1. Framed
2. Framed pass through
3. Unframed

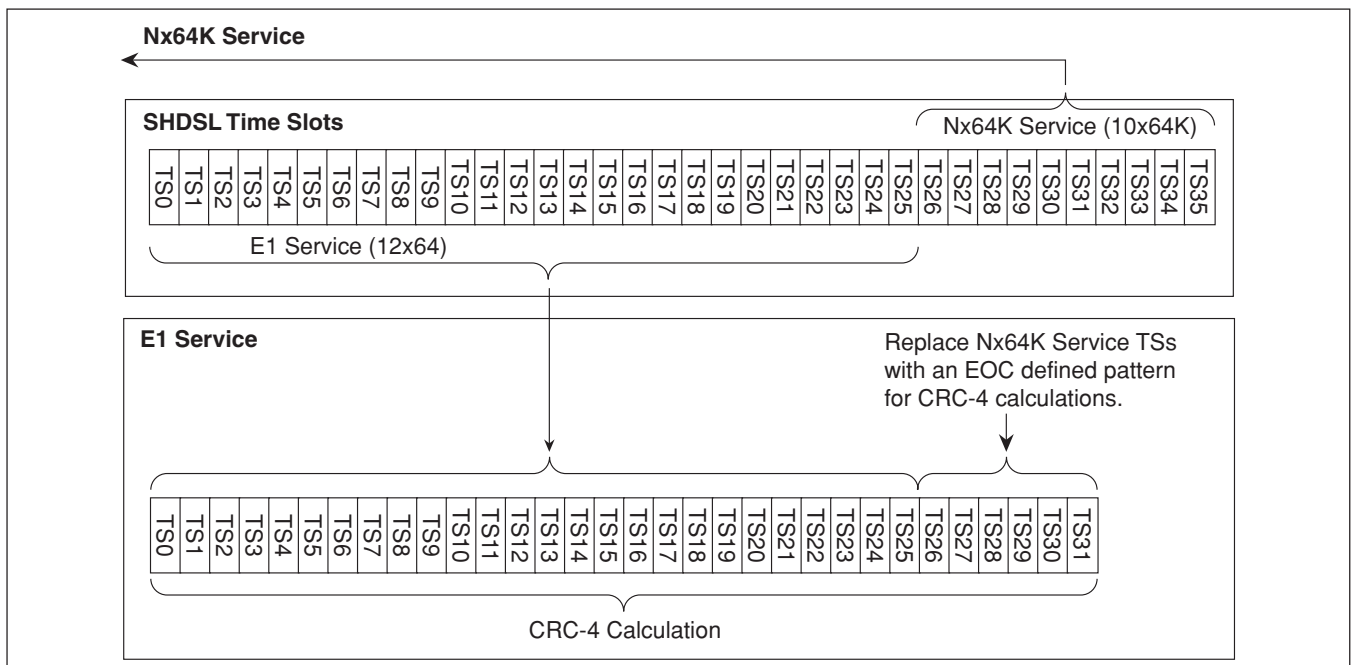

**Figure 22. CRC-4 Detection/Generation**



The NTU provides framing on the E1 port as described in G.704 (sections 2.3 and 5) and G.706 (section 4) and G.736. In this mode, the data arriving at the SHDSL interface need not contain any G.704 framing and the NTU generates the framing. One or more services can be routed into time slots 1-31.

CRC-4 multiframe may be enabled or disabled. The default is disabled. The NTU routes one or more services from the SHDSL payload into time slots 1-31, as well as routing time slot 0. In this mode G.704 framing is present in the data arriving on the SHDSL interface, and this is passed transparently to the G.703 interface.

---

**NOTE**

Not all time slots are necessarily routed between the SHDSL and G.703 interface – some may be routed from the SHDSL to the Nx64K interface. See the *CRC-4 Multiframe* subsection.

---

The NTU monitors the G.704 framing to detect errors (and thus drive the NTU LEDs) and to determine the value of the TS0 spare bits. The NTU transfers all SHDSL payload time slots transparently through the G.703 port without framing or monitoring. In this mode the port operates as a 2 Mbit/s G.703 interface without any G.704 framing. This implies that the whole SHDSL payload comprises a single service.

The following alarm conditions can be monitored on the G.703/G.704 interface (if applicable to the current configuration):

1. AIS (Alarm Indication Signal)
2. BER (Excessive Bit Error Rate)
3. LOMFA (Loss of Multi-Frame Alignment)
4. LOF (Loss of Frame)
5. LOS (Loss of Signal)
6. RAI (Remote Alarm Indication)
7. Slip

When the NTU is configured for an unframed service the only alarm available is LOS. Consequential actions can only be undertaken if G.704 framing is either delivered by the remote unit or is being generated on the NTU. If framing is being generated by the LT then the LT is responsible for these actions.

While any of the alarm states LOS, AIS, LOF, LOMFA and BER are detected, the following consequential actions will occur:

1. The remote alarm indication (bit 3 of the TS0 B- word) will be set as described in the G.704, G.726 and G.706;
2. The G.703/G.704 alarm LED will be on,
3. AIS will be transmitted toward the network in all corresponding data time slots.

---

**NOTE**

RAI assertion by the NTU can be disabled (the default state) under the G.703 Options Screen by the Customer RAI generation option.

---

When remote alarm indication is detected, the alarm condition will be displayed on the front panel.

## 4. SPECIFICATIONS

Table 10 lists the specifications for the Express 6530 SHDSL NxNTU.

**Table 10. Express 6530 SHDSL NxNTU Specifications**

<b>Network Interface</b>	
Line Rate: .....	SHDSL per ITU G.991.2
Line Code: .....	TC PAM
Connector: .....	RJ-45
DSL Timing: .....	Network, Internal, and DTE
<b>DTE Interface (DIGITAL)</b>	
Bit Rate: .....	64 kbps to 2.304 Mbps (Nx64 kbps)
Connectors: .....	CCITT V.35/V.36 (M34 Female Connector) CCITT X.21 (DB15 Female Connector)
<b>DTE Interface (E1)</b>	
Bit Rate: .....	2.048 Mbps
Connector: .....	RJ-45, 120 ohm Balanced Interface
Framing: .....	G.703 (CCS) CRC-4 (enable/disable) Unframed
<b>Craft Port</b>	
Bit Rate: .....	2.4 kbps to 38.4 kbps
Connector: .....	DB-9, Female, V.28
<b>Agency Approvals:</b> K.20, K.21, CISPER 22, IEC 950, CE MARK, 300 386-2	
<b>Environment</b>	
Operating: .....	0°C to 50°C (32°F to 122°F)
Storage: .....	-20°C to 70°C (-4°F to 158°F)
Relative Humidity: .....	Up to 95%, noncondensing
<b>Physical</b>	
Dimensions: .....	1.5 in. H, 9.0 in. W, 6.25 in. D (38.1 mm H, 228.6 mm W, 158.75 mm D)
Weight: .....	2 lbs.
Power: .....	90-240 V, 50-60 Hz, 5 W or -48 VDC
Power Connector: .....	IEC 60320 C13

## 5. WARRANTY AND CUSTOMER SERVICE

ADTRAN will replace or repair this product within five (5) years from the date of shipment if it does not meet its published specifications or fails while in service. Refer to *ADTRAN International Equipment Warranty*, Document: 60000003#I-3.

Contact Customer and Product Service (CAPS) prior to returning equipment to ADTRAN.

For service, CAPS requests, or further information, contact one of the following numbers:

### International Customer and Product Service Contact Numbers

#### ADTRAN, Inc.

Attention: International Department  
901 Explorer Boulevard  
Huntsville, Alabama 35806  
USA  
[www.adtran.com](http://www.adtran.com)

#### U.S. Headquarters

256 963-8000 voice  
256 963-6300 fax  
256 963-8200 fax back  
[international@adtran.com](mailto:international@adtran.com)

#### Asia Pacific - Hong Kong

852 2824-8283 voice  
852 2824-8928 fax  
[sales.asia@adtran.com](mailto:sales.asia@adtran.com)

#### Asia Pacific - Melbourne, Australia

613 9658 0500 voice  
613 9658 0599 fax  
[sales.australia@adtran.com](mailto:sales.australia@adtran.com)

#### Asia Pacific - Beijing, China

8610 8857 6415 voice  
8610 8857 6417 fax  
[sales.china@adtran.com](mailto:sales.china@adtran.com)

#### Canada - Ontario

416 290-0585 voice  
416 296-1259 fax  
[sales.ontario@adtran.com](mailto:sales.ontario@adtran.com)

#### Canada - Quebec

877 923-8726 toll free  
514 940-2888 voice  
514 940-2890 fax  
[sales.quebec@adtran.com](mailto:sales.quebec@adtran.com)

#### Canada - Other Provinces

877 923-8726 toll free  
[sales.canada@adtran.com](mailto:sales.canada@adtran.com)

#### Europe - Germany

49 6007 930 203 voice  
49 6007 930 204 fax  
256 963-8695 (USA)  
[sales.europe@adtran.com](mailto:sales.europe@adtran.com)

#### Latin America/Caribbean

954 474-4424 (USA) voice  
954 474-1298 fax  
[sales.latin@adtran.com](mailto:sales.latin@adtran.com)

#### Mexico

954 474-4424 (USA) voice  
954 577-0358 fax  
[sales.mexico@adtran.com](mailto:sales.mexico@adtran.com)

