



ISU 512
ISDN Service Unit

USER MANUAL

	Part Number
ISU 512 (U Interface)	1202086L1
ISU 512 ST (ST Interface)	1202086L2
RS-530 to V.35 Adapter	1200072L1
RS-366 Y Cable	1200120L1
RJ-45 to DB-25 Adapter	3196.ADPT003

61202.086L1-1B
September 1997

Trademark:

5ESS is a registered trademark of AT&T

DMS-100 is a trademark of Northern Telecom, Inc.

ISU is a trademark of ADTRAN, Inc.



901 Explorer Boulevard
P.O. Box 140000
Huntsville, AL 35814-4000
Phone: (205) 963-8000

© 1997 ADTRAN, Inc.
All rights reserved.
Printed in USA.

FCC regulations require that the following information be provided in this manual:

1. This equipment complies with Part 68 of the FCC rules. On the bottom of the equipment housing is a label that shows the FCC registration number and Ringer Equivalence Number (REN) for this equipment. If requested, provide this information to the telephone company.
2. If this equipment causes harm to the telephone network, the telephone company may temporarily discontinue service. If possible, advance notification is given, otherwise, notification is given as soon as possible. The telephone company will advise the customer of the right to file a complaint with the FCC.
3. The telephone company may make changes in its facilities, equipment, operations, or procedures that could affect the proper operation of this equipment; advance notification and the opportunity to maintain uninterrupted service is given.
4. If experiencing difficulty with this equipment, please contact ADTRAN for repair and warranty information. The telephone company may require this equipment to be disconnected from the network until the problem is corrected, or it is certain the equipment is not malfunctioning.
5. This unit contains no user serviceable parts.
6. An FCC compliant telephone cord with a modular plug is provided with this equipment. In addition, an FCC compliant cable appropriate for the dial backup option ordered is provided with this equipment. This equipment is designed to be connected to the telephone network or premises wiring using an FCC compatible modular jack, which is Part 68 compliant.
7. The following information may be required when applying to the local telephone company for leased line facilities.

Service Type	Digital Facility Interface Code	Service Order Code	Network Jacks
ISDN	021S5	6.0F	RJ-49C

**FEDERAL COMMUNICATIONS COMMISSION
RADIO FREQUENCY INTERFERENCE STATEMENT**

1202086L1

This equipment has been tested and found to comply with the limits for a Class B digital device, pursuant to Part 15 of the FCC Rules. These limits are designed to provide reasonable protection against harmful interference in a residential environment. This equipment generates, uses, and can radiate radio frequency energy and, if not installed and used in accordance with the instructions, may cause harmful interference to radio or TV reception, which can be determined by turning the equipment off and on. The user is encouraged to try to correct the interference by one or more of the following measures:

- *Reorient or relocate the receiving antenna.*
- *Increase the separation between the equipment and receiver.*
- *Connect the equipment into an outlet on a circuit different from that to which the receiver is connected.*
- *Consult the dealer or an experienced radio/TV technician for help.*

WARNING

Change or modifications to this unit not expressly approved by the party responsible for compliance could void the user's authority to operate the equipment.

1202086L2

This equipment has been tested and found to comply with the limits for a Class A digital device, pursuant to Part 15 of the FCC Rules. These limits are designed to provide reasonable protection against harmful interference in a residential environment. This equipment generates, uses, and can radiate radio frequency energy and, if not installed and used in accordance with the instructions, may cause harmful interference to radio or TV reception, which can be determined by turning the equipment off and on. The user is encouraged to try to correct the interference by one or more of the following measures:

- *Reorient or relocate the receiving antenna.*
- *Increase the separation between the equipment and receiver.*
- *Connect the equipment into an outlet on a circuit different from that to which the receiver is connected.*
- *Consult the dealer or an experienced radio/TV technician for help.*

WARNING

Change or modifications to this unit not expressly approved by the party responsible for compliance could void the user's authority to operate the equipment.

CANADIAN EMISSIONS REQUIREMENTS

1202086L1

This digital apparatus does not exceed the Class B limits for radio noise emissions from digital apparatus as set out in the interference-causing equipment standard entitled "Digital Apparatus," ICES-003 of the Department of Communications.

Cet appareil numérique respecte les limites de bruits radioélectriques applicables aux appareils numériques de Class B prescrites dans la norme sur le matériel brouilleur: "Appareils Numériques," NMB-003 édictée par le ministre des Communications.

1202086L2

This digital apparatus does not exceed the Class A limits for radio noise emissions from digital apparatus as set out in the interference-causing equipment standard entitled "Digital Apparatus," ICES-003 of the Department of Communications.

Cet appareil numérique respecte les limites de bruits radioélectriques applicables aux appareils numériques de Class A prescrites dans la norme sur le matériel brouilleur: "Appareils Numériques," NMB-003 édictée par le ministre des Communications.

CANADIAN EQUIPMENT LIMITATIONS

Notice: The Canadian Industry and Science Canada label identifies certified equipment. This certification means that the equipment meets certain telecommunications network protective, operational, and safety requirements. The Department does not guarantee the equipment will operate to the user's satisfaction.

Before installing this equipment, ensure that it is permissible to be connected to the facilities of the local telecommunications company. The equipment must also be installed using an acceptable method of connection. In some cases, the company's inside wiring associated with a single-line individual service may be extended by means of a certified connector assembly (telephone extension cord). Compliance with the above conditions may not prevent degradation of service in some situations.

Repairs to certified equipment should be made by an authorized Canadian maintenance facility designated by the supplier. Any repairs or alterations made by the user to this equipment, or equipment malfunctions, may give the telecommunications company cause to request the user to disconnect the equipment.

Users should ensure for their own protection that the electrical ground connections of the power utility, telephone lines, and internal metallic water pipe system, if present, are connected together. This precaution may be particularly important in rural areas.



Users should not attempt to make such connections themselves, but should contact the appropriate electric inspection authority, or an electrician, as appropriate.

The **Load Number (LN)** assigned to each terminal device denotes the percentage of the total load to be connected to a telephone loop which is used by the device, to prevent overloading. The termination on a loop may consist of any combination of devices subject only to the requirement that the total of the Load Numbers of all devices does not exceed 100.

Quick Start Guide

Before configuring the ISU™ 512, the telephone service provider must supply the switch type, service profile identifier (SPID), and local directory number (LDN). For example, for one ISDN BRI 2B+D line:

Switch Type	National ISDN-1
SPID1	20455512120100
SPID2	20455512130100
LDN1	5551212
LDN2	5551213

To configure the ISU 512 from the front panel press **Enter** from the initial status screen and continue entering the appropriate numbers until the Switch type, SPIDs and LDNs have been entered. (Note: Outside the U.S. and Canada, you will not need to enter SPIDs.)

3=CONFIG	1=Netw. options	1=Dial Line	1=Switch type	1=AT&T 5ESS
	2=DTE options	2=Leased Line	2=Call type	2=DMS-100
	3=BONDING setup		3=Terminal ID	3=NATIONAL ISDN 1
	4=Quick setup		4=Dial options	4=NEC
			5=Auto answer	5=EuroISDN
			6=Connect Timeout	1=Set SPID
			7=Call Screening	2=Set LDN
			8=Passwords	
			9=Maint Setup	

Press **Cancel** to exit to the status screen and verify **Ready** conditions for each BRI line configured. If the status screen reads **SYNC, DOWN, TEL, or SPID**, either the configuration of the switch type and SPIDs are incorrect or there may be a problem with the ISDN line or translations; see the chapter *Troubleshooting*. Outside of the U.S. and Canada, only the LDNs will need to be entered.

Service Profile/ Directory Number	Line Interface	Maximum Bandwidth
SPID1/LDN1 SPID2/LDN2	Line 1	128 kbps
SPID3/LDN3 SPID4/LDN4	Line 2	256 kbps
SPID5/LDN5 SPID6/LDN6	Line 3	384 kbps
SPID7/LDN7 SPID8/LDN8	Line 4	512 kbps

To configure the ISU 512 using the VT 100 terminal interface, use the following procedure:

1. Connect a VT 100 async terminal, or personal computer with a terminal emulator package, to the Chain In port using an RJ-45 cable and the RJ-45 to DB-25 adapter (part number 3196.ADPT003).
2. Configure the terminal for 9600 bps, 8 data bits, 1 stop bit, no parity (8/1/n).
3. Type **!V** and press **Enter**.
4. When the terminal displays the Configuration menu, enter the assigned SPIDs, LDNs, and switch type.
5. Connect the ISDN lines.

Once the **Ready** condition has been achieved, a call can be placed from the Configuration menu using the **Ctl+D** command, a test can be run using **Ctl+T**, or the status of the line can be checked using **Ctl+V**. The status of the line and the interface leads can be monitored while a call is active. **Ctl+X** exits the VT 100 terminal and returns control to the Maintenance interface.

Table of Contents

Chapter 1. Understanding ISDN and the ISU 512	1
ISDN Overview	1
Product Overview	1
ISU 512 Interoperability	4
Recommended Operating Protocols.....	5
Chapter 2. Ordering ISDN	7
Chapter 3. Installation	9
Installation	9
Network Connection.....	9
DTE Data Connection	10
Dial Interface Connection.....	10
Smart Dial String Formats	10
The Maintenance Interface.....	12
Software Update	13
VT 100 Menu Interface	14
Chapter 4. Operation	19
Initial Self Test	19
Menu Structure	20
Main Menu	20
Status Menu	20
Test Menu.....	20
Configuration (CONFIG) Menu	21
Dial Menu.....	21
Basic Menu Traversal.....	21
Front Panel	22
LCD Window	23
Enter	23
Numeric Keypad	23
Cancel.....	23
Up and Down Arrows	23
LED Description	23
Chapter 5. Configuration	25
Using ISDN Basic Rate Switched Service	25
Configuring Network Options for Dial Operation	27
Switch Type	27
Call Type.....	27
Speech.....	28
Audio	28

Table of Contents

Data 56 kbps.....	28
Data 64 kbps.....	28
Terminal Identification	29
Setting the SPID.....	29
Setting the LDN.....	30
Dial Options.....	30
Front Panel	31
RS-366	31
1 sec or EON.....	31
2 sec or EON.....	31
5 sec or EON (default).....	32
10 sec or EON.....	32
20 sec or EON.....	32
Wait for EON	32
Security	32
V.25 bis.....	32
Auto Answer	33
Disabled.....	33
Enabled.....	33
Dump all calls.....	33
Connect Timeout.....	34
Call Screening.....	34
Remote Access.....	35
Remote Download (RDL)	35
Remote Supervision.....	36
Maintenance Setup	37
Auto Traps.....	37
ADLP Address.....	37
Port Mode	37
Call NumID	38
Configuring the ISU 512 for Leased Digital Service.....	39
Clock Mode.....	39
Channel Rate	40
Test Remote	41
Maintenance Setup	41
Auto Traps.....	41
ADLP Address.....	41
Port Mode	41
Setting DTE Options	42
Maximum Bit Rate.....	42
Connector Type.....	43
RS-530 to V.35 Cable.....	43
RS-366 Y Cable	43
CTS Options.....	44
CD Options	44
DTR Options.....	44
DSR Options.....	45
BONDING setup	46

TXINIT	46
TXFA.....	47
TXADD01.....	47
TXDEQ	47
TANULL	47
TCID	48
Call Stagger.....	48
Transparent 2x Clear Channel Protocol.....	49
Quick Setup Configuration.....	50
Dial 512K.....	50
Dial 384K.....	51
Dial 448K.....	51
Dial 336K.....	51
Video 384K.....	52
Video 336K.....	52
Leased Master	52
Leased Slave and Ldm SlvMstr	53
Dialing Options	54
Hang Up Line.....	54
Dial Number.....	54
Redial Last Number	54
Answer Call.....	54
Dial Stored Number	54
Store/Review Number	55
Configuring the ISU 512 for V.25 bis In-band Dialing.....	56
Chapter 6. Testing	57
Test Options	57
Loopback DTE.....	57
Loopback Protocol.....	57
2047 Checker	58
Near-End Block Errors/Far-End Block Errors (NEBE/FEBE)	59
Software Version.....	59
Chapter 7. Troubleshooting	61
If Self Test Fails.....	61
If an ISDN Network Line Reads Down	61
If the Display Reads TEI1	63
If the Display Reads TEI2	64
If the Display Reads SPID{1,3,5, or 7}.....	65
If the Display Reads SPID{2,4,6, or 8}.....	65
Chapter 8. Specifications Summary.....	67
Specifications and Features.....	67
Network Interface	67
DTE Interface	67
Dialing Selections	67
Data Rates.....	67

Table of Contents

Rate Adaption	67
Interoperability	67
D Channel Switch Compatibility	68
B Channel Aggregation	68
Display	68
Environmental	68
Physical	68
Power.....	68
Appendix A. Status Buffer Messages	69
Appendix B. S-Register List	79
Appendix C. AT Commands	85
Appendix D. Pinouts	89
Acronyms	97
Glossary.....	99
Index	107

List of Figures

Figure 1-1:	ISU 512 Rear Panel	2
Figure 1-2:	ISU 512 (U interface) Applications	4
Figure 3-1:	Maintenance Port VT 100 Menu	12
Figure 3-2:	VT 100 Configuration Menu	15
Figure 3-3:	VT 100 Configuration Menu 2	15
Figure 3-4:	VT 100 Status Screen	16
Figure 3-5:	VT 100 Test Menu	16
Figure 3-6:	VT 100 Dial Menu	17
Figure 4-1:	Network Connection Status	19
Figure 4-2:	LCD Display of the Main Menu	20
Figure 4-3:	ISU 512 Front View	22
Figure 5-1:	Configuration Menu	26
Figure 5-2:	Dial Options Menu	31
Figure 5-3:	Leased Line Menu	39
Figure 5-4:	Limited Distance Modem Application	40
Figure 5-5:	Leased Application with Channel Banks	40
Figure 6-1:	ISU 512 Loopback Points	57
Figure D-1:	EIA-232 to DB-25 Adapter Connector	89
Figure D-2:	RJ-45 ISDN Line Interface	89
Figure D-3:	EIA-232, RS-366, and RS-530 Connector	90
Figure D-4:	V.35 Connector	90
Figure D-5:	RS-366 Y Cable	95
Figure D-6:	RS-530 to V.35 Adapter Cable	95

Table of Contents

List of Tables

Table 1-A: ISU 512 Synchronous Rates	5
Table C-A: AT Commands	85
Table D-A: Pinouts for Chain In and Chain Out Ports	89
Table D-B: Pinouts for IFC RJ-45 Connectors	90
Table D-C: RS-366 Dialing Port Pinouts	91
Table D-D: RS-530 Pinouts	92
Table D-E: V.35 Pinouts	93
Table D-F: RS-530-to-V.35 Adapter Cable Pinouts	94

Table of Contents

Chapter 1

Understanding ISDN and the ISU 512

ISDN OVERVIEW

The Integrated Services Digital Network (ISDN) is a public or private switched digital network. ISDN is an international standard for digital communications, allowing a full range of enhanced services supporting voice, data, and image applications through standard interfaces over a single pair of telephone wires. ISDN provides a means of integrating these services and modernizing communication networks for information movement and management efficiency.

PRODUCT OVERVIEW

The ADTRAN ISDN Service Unit (ISU™) 512 is a stand alone device that connects data terminal equipment (DTE) to the ISDN network or to a leased digital network for data transmission. The ISU 512 is a basic inverse multiplexer that provides cost-effective high-speed data transmission for a single application at rates up to 512 kbps.

From the network, ISDN is delivered by up to four 2-wire 2B1Q ISDN Basic Rate U-interfaces which connect directly to the ISU 512 (U interface). ISDN network termination is designed into the ISU 512, eliminating the need for separate NT1s. For network testing, the ISU 512 responds to NT1 test commands from the telephone company central office (CO). The ISU 512 (ST interface) is designed to work with the 4-wire AMI signals provided by an NT1.

The ISU 512 transmits data over an RS-530 or V.35 interface, selectable from the front panel. The ISU 512 performs at synchronous data transfer rates of 56 kbps to 512 kbps. At rates over 64 kbps, the BONDING Mode 1 inverse multiplexing protocol synchronizes data over up to eight 64 kbps B channels. By supporting BONDING, the ISU 512 interoperates with other BONDING-compatible inverse multiplexers and ISDN terminal adapters. The ISU 512 is intended to support the transfer of data and images over ISDN.

The ISU 512 has four RJ-45 jacks available on the rear panel for network connection (see Figure 1-1).

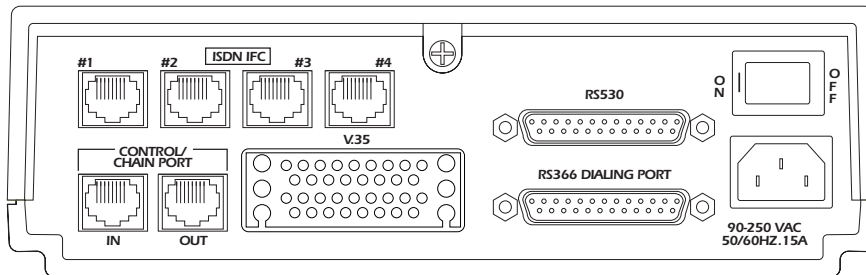

Figure 1-1
ISU 512 Rear Panel

The ISU 512 (U interface) also supports a leased digital connection that allows data to be transferred at up to 512 kbps. This type of service is a permanent connection between end points and is sometimes referred to as a leased connection, a dedicated connection, a nailed-up connection, a private circuit, or a limited distance modem (LDM) connection. Leased connection or leased application is used in this manual to represent these types of services.

The ISU 512 can be configured using the front panel keypad, remotely over the ISDN line, or using a VT 100 terminal operating at 9600 bps (8 data bits, 1 stop bit, no parity). The VT 100 terminal interface is connected to the ISU 512 through the Chain In port on the rear of the unit. See the section *VT 100 Menu Interface* in Chapter 3 for more information. The front panel keypad and the terminal interface support test modes, test status, and dialing.

Dialing from the ISU 512 is accomplished in a variety of ways:

- Manually from the front panel keypad.
- Manually from up to ten stored numbers.
- Automatically through an RS-366 dialing port used in video conferencing applications; a special RS-366 Y cable provides the two RS-366 interfaces for this application (part number 1200120L1).
- V.25 bis in-band dialing (used in applications such as LAN/WAN bridging).
- Dialing while DTR is enabled. From Stored Number 0.
- Dialing from the VT 100 terminal interface.

The ISU 512 (U interface) also supports dedicated leased 2B1Q services. This provides a dedicated point-to-point service (as in a limited distance modem or leased line application) with no dialing necessary.

The ISU 512 is designed to operate in a dual-port mode for videoconferencing at 112/128 kbps. This allows end-to-end compatibility when communicating with a video system that is utilizing two Switched 56 DSUs or a dual-port ISDN terminal adaptor. For this application, 56/64 kbps is transmitted over the V.35 interface and the RS-530 interface. An RS-530 to V.35 adapter (part number 1200072L1) is available to provide the necessary V.35 interface for the second port. Also, a special RS-366 Y cable (part number 1200120L1) provides the two RS-366 interfaces for this application. For convenience in communicating with multiple video sites, the ISU 512 transparently switches between the dual-port mode at 112/128 kbps and the single-port mode of 336/384 kbps without user intervention and reconfiguration of the unit.

ISU 512 INTEROPERABILITY

Telephone networks are evolving from analog technologies to digital technologies such as ISDN. This transition is time-consuming and costly for telephone companies and upgrading all locations and facilities is a lengthy process.

The ISU 512 bridges this transition by supporting communications with existing and future network services and equipment. The ISU 512 supports communications with Switched 56 (SW56) Service and Switched 56 DSUs (2-wire and 4-wire) as well as various ISDN terminal adapters, ISDN terminal equipment, and BONDING Mode 1-compatible inverse multiplexers.

Figure 1-2 illustrates the ISU 512 (U interface) operation in various switched network services and customer premises products.

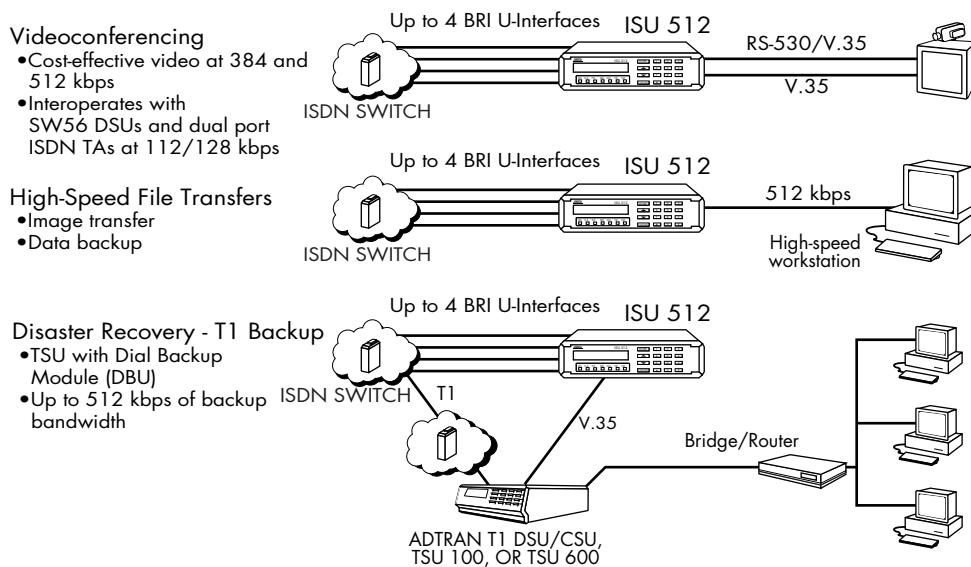

Figure 1-2
ISU 512 (U interface) Applications



The ISU 512 (ST interface) will also support these configurations but will require an external NT1 for each BRI line.

RECOMMENDED OPERATING PROTOCOLS

The ISU 512 supports BONDING Mode 1. For applications such as videoconferencing, in which the unit needs to interoperate with two SW56 lines or one dual-port ISDN device, the 2 x clear channel protocol (dual-port mode) is used. The ISU 512 automatically uses the 2 x clear channel protocol whenever it does not find a BONDING partner. The first call (incoming or outgoing) connects to the V.35 port in 2 x clear channel protocol. The second call (incoming or outgoing) connects to the RS-530 port. An RS-530 to V.35 cable (part number 1200072L1) may be required in some applications. Table 1-A lists the synchronous rates supported by the ISU 512, and the number of interfaces required from the telephone company to accomplish the rate.

Table 1-A
ISU 512 Synchronous Rates

Rates (Synchronous)	Rate Adaption Method	IFCs Required
1x56K	BONDING/Clear Channel	1
1x64K	BONDING/Clear Channel	1
2x56K	BONDING/2 x Clear Channel Protocol	1
2x64K	BONDING/2 x Clear Channel Protocol	1
3x56K	BONDING	2
3x64K	BONDING	2
4x56K	BONDING	2
4x64K	BONDING	2
5x56K	BONDING	3
5x64K	BONDING	3
6x56K	BONDING	3
6x64K	BONDING	3
7x56K	BONDING	4
7x64K	BONDING	4
8x56K	BONDING	4
8x64K	BONDING	4

Chapter 2

Ordering ISDN

ISDN is a complex service with many network options. Obtaining service from the local telephone company and long distance providers can be complicated.

The following instructions only apply to North American switches.

In North America, the development of ISDN Ordering Codes (IOCs) simplifies the process of ordering ISDN service. The ISDN Solutions Group, a consortium of ISDN equipment vendors, service providers, and Bellcore, established these codes to represent predetermined line configurations for ISDN Basic Rate service for specific applications.

ADTRAN and Bellcore have registered and tested eight generic IOCs. These IOCs are supported by all major local exchange carriers as well as several independent carriers.

Capability S (previously **Generic Data M**) ordering code is recommended for ISU 512 applications. It is the most feature-rich and supports most voice and data applications. The voice capability is not necessary for operation of the ISU 512; however it is useful in troubleshooting a misconfigured ISDN line. In some areas, ISDN tariffs may warrant the use of ordering codes with less features. For example, in a particular region, there may be additional monthly expense associated with having voice service on each B channel. If you have a data only application **Capability R** (previously **Generic Data I**) may be more cost-effective. Each ISDN line provides 112/128 kbps of service. If 512 kbps is needed for your application, order four ISDN lines. If 384 kbps is needed, only order three ISDN lines, etc.

For more information regarding ordering ISDN, see the ADTRAN document *Ordering ISDN Service User Guide* part number 60000.015-8, or contact the telephone company for alternative line configurations. The *Ordering ISDN Service User Guide* is available on the ADTRAN home page at <http://www.adtran.com> (go to the Service and Support page and then to the ISDN Information Desk) or by calling ADTRAN at (205) 963-8000.

Chapter 3 Installation

INSTALLATION

After unpacking the unit, immediately inspect it for possible shipping damage. If damage is discovered, file a claim immediately with the shipping carrier, then contact ADTRAN Customer Service; see the inside back cover of this manual for phone numbers.

NETWORK CONNECTION

The ISU 512 (U interface) supports either **Dial** or **Leased** operation. The ISU 512 (ST interface) supports only **Dial** operation. Four 8-pin RJ-45 modular jacks on the rear panel of the ISU 512 allow connection to either network service.

Dial operation uses the ISDN Basic Rate interface and allows the ISU 512 to dial out over the ISDN network. When used in this mode of operation, the telephone company provided ISDN Basic Rate interface is connected to the RJ-45 connectors marked **ISDN IFC #1, #2, #3, and #4**. Connect the Basic Rate interfaces to the ISU 512 in order, starting with **ISDN IFC #1**, until the maximum number of lines (four) is reached.

The **Leased** mode of operation supports a dedicated 2B1Q data service at rates of up to 512 kbps by using nailed up circuits or a permanent connection between end points. This could be a limited distance modem or point-to-point connection.

See the appendix *Pinouts* for network connection pin assignments.

DTE DATA CONNECTION

Data terminal equipment (DTE) is connected to the ISU 512 by using the V.35 interface, and/or the RS-530 interface on the rear panel of the ISU 512. The maximum cable lengths recommended are 50 feet for the RS-530 interface, or 150 feet for the V.35 interface. The pin assignments for the DTE interfaces are shown in the appendix *Pinouts*.

The RS-530 interface and the V.35 interface support data rates up to 512 kbps. The DTE rate can be configured from the front panel or the VT 100 terminal interface of the ISU 512. See the chapter *Configuration* for information regarding configuring the ISU 512 with the appropriate data rates for the application.



CAUTION To prevent possible radio frequency interference emissions, shielded cables are required.

DIAL INTERFACE CONNECTION

If out-of-band RS-366 dialing is required for applications such as video conferencing, the dialing interface of the host DTE should be connected to the port labeled **RS366 DIALING PORT**. A special RS-366 Y cable provides the two RS-366 interfaces required for dual-port videoconferencing applications (part number 1200120L1). For pin assignment information for the RS-366 connector and the RS-366 Y cable, see the appendix *Pinouts*.

Smart Dial String Formats

The ISU 512 accepts changes to **Call Type** and **Channel Rate** by using suffix commands appended to the end of the dial string. The following string format is used.

dial string call type channel rate
|-----|-----|-----|
|XXX XXX XXXX|#C #R

Where #C changes the Call Type as follows:

- 1 = Speech
- 2 = Audio
- 3 = 56K Data
- 4 = 64K Data

Where #R changes the Channel Rate (number of ISDN B channels) as follows:

0 = (2x56k and 2x64k) 2 x Clear Channel Protocol
 1 = 1 B Channel (1x56k, 1x64k) BONDING Mode 1
 2 = 2 B Channels (2x56k, 2x64k) BONDING Mode 1
 3 = 3 B Channels (3x56k, 3x64k) BONDING Mode 1
 4 = 4 B Channels (4x56k, 4x64k) BONDING Mode 1
 5 = 5 B Channels (5x56k, 5x64k) BONDING Mode 1
 6 = 6 B Channels (6x56k, 6x64k) BONDING Mode 1
 7 = 7 B Channels (7x56k, 7x64k) BONDING Mode 1
 8 = 8 B Channels (8x56k, 8x64k) BONDING Mode 1

The following are dialing examples:

Two-port call using 64k call type (2x64)	7082906055#4#0
Two-port call using 56k call type (2x56k)	7082906055#3#0
BONDING 384k using 64k call type (6x64k)	7082906055#4#6
BONDING 336k using 56k call type (6x56k)	7082906055#3#6
BONDING 256k using 64k call type (4x64k)	7082906055#4#4

If no suffix is used, the call is placed using the values configured for the ISU 512. For example, if the ISU 512 is configured for 384K, the dial string 7082906055 is the same as 7082906055#4#6.

If the Channel Rate suffix is used, the Call Type suffix is required. However, the Channel Rate is not required to make changes to the Call Type. For example, if the ISU 512 is configured for 384K Call Type, only the #3 suffix is required to change the Call Type to 336K. The dial string 7082906055#3 is the same as 7082906055#3#6.

When placing non-bonded two channel calls, the originating end must use both the Call Type and Channel Rate suffixes; otherwise, the ISU 512 attempts to negotiate BONDING before using 2 x Clear Channel protocol. This works for Ascend and ADTRAN; Promptus hangs the call up. Using the Channel Rate suffix #0 causes the ISU 512 to omit BONDING negotiation and use only 2 x Clear Channel protocol; this succeeds with all vendors.

THE MAINTENANCE INTERFACE

The Maintenance Interface is available at 9600 bps, 8 data bits, no parity, through the **CHAIN IN** port. See the appendix *Pinouts* for the Chain In port pinout. The VT 100 terminal or null modem can be connected to the Chain In port using the RJ-45 to DB-25 adapter (part number 3196.ADPT003) and the RJ-45 to RJ-45 cable provided with the unit. The port contains transmit and receive data (EIA-232 compatible). This interface can be used to set internal S-registers, dial ISDN connections, and disconnect calls. This port also allows ADTRAN Technical Support personnel to retrieve vital information from the unit if a problem is encountered during initial configuration of the ISU 512. Most problems can be solved without resorting to this port for assistance.

The terminal should be set for **9600 bps, 8 data bits, and no parity**. The maintenance port is activated by typing **!V** at the **--512-->** prompt.

There are four maintenance port commands available to display and clear the status buffer, display the internal print buffer, loop status and help screen; see Figure 3-1.

```
.... Adtran ISU512 Maintenance Port Help ....
      !V - VT100 configuration and status menus
      !E - Display and clear status buffer
      !P - Display internal printf buffer
      !U - Display loop status
      !G - Restart ISDN Lines
      !? - Display help

--512-->
```

Figure 3-1
Maintenance Port VT 100 Menu

WARNING *Plugging the RJ-45 cable from the telephone service provider into the **Chain In** or **Chain Out** ports could cause damage to the ISU 512.*

Software Update

There are two methods available for updating ISU 512 software. The local method involves using the Chain In port and is described in this section. The remote method involves transmitting smart dial strings over a dial-up connection and is described in the section *Remote Access* of the chapter *Configuration*.

The ISU 512 contains Flash memory allowing the software to be updated using the Chain In port. The ISU 512 software can be updated using any PC with an EIA-232 COM port and a communication package supporting XMODEM protocol. Download speed and format are set to 38400 bps, 8 data bits, 1 stop bit, no parity, and no flow control. After obtaining a new code file with the extension (.bin) from Technical Support (see the inside back cover), use the following procedure to update the software:



NOTE

Ensure the terminal software package has flow control turned off.

1. Power the ISU 512 *Off*.
2. Connect the PC to the ISU 512 using an RJ-45 to DB-25 adapter (part number 3196.ADPT003) connected from the Chain In (RJ-45) connector on the rear panel of the ISU 512 to the COM port on the PC. See the appendix *Pinnouts* for a diagram of this cable.
3. Start the communication package, supporting XMODEM protocol, on the PC. Set for Connect Local if necessary.
4. Set the COM port for **38400, 8, 1, n** and **no flow control**.
5. Start the XMODEM protocol and transfer the .bin file to the ISU 512. XMODEM should come on-line and wait for the far end to connect. The far end in this case is the ISU 512.
6. Power *On* the ISU 512 while holding the **Up Arrow**. Holding the **Up Arrow** during self test initiates the software update.



CAUTION

*Do not power *Off* the unit during the loading process. After the load is complete the ISU 512 restarts itself. If power is lost during the software load, repeat the procedure from the beginning.*



NOTE

It may be necessary to set the communications software to Connect Local, which sets the session up to ignore carrier detect on the EIA-232 port and transfer files anyway.

VT 100 MENU INTERFACE

The VT 100 menu interface can be used by connecting a VT 100 compatible terminal to the Chain In port on the back of the ISU 512. The VT 100 terminal (or PC running terminal emulation software) is connected to the Chain In port using the RJ-45 to DB-25 adapter (part number 3196.ADPT003) and the RJ-45 to RJ-45 cable provided with the unit. See the appendix *Pinouts* for the Chain In port pinout information. The Chain In port is a DCE connector that contains transmit (Tx) and receive (Rx) data (EIA-232 compatible signals) and system ground. The terminal should be set for **9600 bps, 8 data bits, 1 stop bit, and no parity**. The VT 100 menu is activated by typing **!V** at the **-- 512->** prompt.

Remote access to the ISU 512 is supported through the Chain In port by use of a null modem cable connected to a modem (DCE interface). Use the RJ-45 to DB-25 adapter (part number 3196.ADPT003) and the RJ-45 to RJ-45 cable to connect the modem to the Chain In port. Ensure that the modem is set for **Ignore DTR** and **Auto Answer** is enabled.

The VT 100 menu interface can be used instead of the front panel to set options and dial up ISDN connections. Test functions and unit status can also be obtained by using the VT 100 menu interface. To select a function, press the number corresponding to the function and press **Enter**.

The bottom of each screen displays commands available for accessing other menus or exiting the VT 100 interface. These commands require the use of the **Control** key (**Ctl**) and a letter.

The first screen displayed is the Configuration Screen (**Ctl+C**). From this screen ISU 512 options are configured; see Figure 3-2. Selecting option **32)-MORE-** displays a second Configuration screen with additional setup options; see Figure 3-3.

The Status Screen (**Ctl+V**) is used to view the current status of the ISU 512; see Figure 3-4. The Test Screen (**Ctl+T**) activates DTE and protocol loopbacks; see Figure 3-5. The Dial Screen (**Ctl+D**) is used to dial and terminate calls; see Figure 3-6.

Select **Ctl+X** to exit the VT 100 menu interface and return control to the Maintenance interface. See the section *The Maintenance Interface* for more information.

```

ISU 512 Configuration Menu
1) Netw. options = Dial Line      17) LDN 6 =
2) Switch type = AT&T 5ESS      18) LDN 7 =
3) Call type = Data 64Kbps      19) LDN 8 =
4) SPID 1 = 0192255360          20) Dial options = Front Panel
5) SPID 2 = 0192255370          21) Auto answer = Enabled
6) SPID 3 =                      22) Connect Timeout = 30 sec (def)
7) SPID 4 =                      23) Call Screening = Answer any
8) SPID 5 =                      24) Auto Traps = Disable
9) SPID 6 =                      25) Call NumID = Enabled
10) SPID 7 =                     26) Max Bit Rate = 64K Mode1
11) SPID 8 =                     27) 64K Mode1 = 8x64K
12) LDN 1 = 9225536              28) Connector Type = RS-530
13) LDN 2 = 9225537              29) 530-U35 Cable = Disabled
14) LDN 3 =                      30) RS366-Y Cable = Disabled
15) LDN 4 =                      31) CTS Options = Off U.25 ANSR
16) LDN 5 =                      32) -- MORE --
-----
Select =                          Enter SELECT   Esc NO CHANGE
-----
Cti-V STATUS  Cti-T TEST  Cti-C CONFIG  Cti-D DIAL   Cti-X EXIT

```

Figure 3-2
VT 100 Configuration Menu

```

ISU 512 Configuration Menu
1) CD Options = Normal
2) DTR Options = Ignore DTR
3) DSR Options = DSR forced on
4) TXINIT = 50 sec
5) TXFA = 10 sec (def)
6) TXADD01 = 50 sec (def)
7) TXDEQ = 50 sec (def)
8) TANULL = 50 sec
9) TCID = 5 sec (def)
10) CALL STAGGER = 100 msec
11) Quick setup
12) -- MORE --
-----
Select = _                          Enter SELECT   Esc NO CHANGE
-----
Cti-V STATUS  Cti-T TEST  Cti-C CONFIG  Cti-D DIAL   Cti-X EXIT

```

Figure 3-3
VT 100 Configuration Menu 2

```
ISU 512 Status Menu
UNIT/LOOP STATUS          STATUS BUFFER
Loop Rate                 = Data 64Kbps      1 = Hardware Rev. F
Max Bit Rate              = 64K Mode1       2 = EMPTY
DTE Format                 = Synchronous     3 = EMPTY
Test Status               = No Test         4 = EMPTY
Self Test                 = Passed          5 = EMPTY
Software Rev              = ISU Ver G.04    6 = EMPTY
Checksum                  = 86fa           7 = EMPTY
Loop Status 1             = Down            8 = EMPTY
Loop Status 2             = Down            9 = EMPTY
Loop Status 3             = Down           10 = EMPTY
Loop Status 4             = Down           11 = EMPTY
Num Dialed                = No Call        12 = EMPTY
RTS                       = OFF           13 = EMPTY
CTS                       = OFF           14 = EMPTY
TD                        = OFF           15 = EMPTY
RD                        = OFF           16 = EMPTY
DCD                       = OFF           17 = EMPTY
DTR                       = OFF           18 = EMPTY
DSR                       = ON            19 = EMPTY
                          20 = EMPTY

Cti-U STATUS  Cti-T TEST  Cti-C CONFIG  Cti-D DIAL  Cti-X EXIT
```

Figure 3-4
VT 100 Status Screen

```
ISU 512 Test Menu
Test
1) Loopback DTE
2) Loopback Protocol
3) NEBE/FEBE
4) 2047 Checker
Menu option:

Cti-U STATUS  Cti-T TEST  Cti-C CONFIG  Cti-D DIAL  Cti-X EXIT
```

Figure 3-5
VT 100 Test Menu

```
ISU 512 Dial Menu
1) Hang up line
2) Dial number
3) Redial last #
4) Answer Call
5) Dial stored #
6) Store/Review #
Menu option:

Cti-V STATUS  Cti-T TEST  Cti-C CONFIG  Cti-D DIAL  Cti-X EXIT
```

Figure 3-6
VT 100 Dial Menu

Chapter 4 Operation

INITIAL SELF TEST

The ISU 512 performs an initial self test upon initial installation. Once the self test is successfully completed, the current status mode is displayed. If the ISU 512 is not connected to the network, the Status menu displays **DOWN** next to the network connection number. If the unit is connected to the network and functioning properly, **READY** is displayed next to the network connection number; see Figure 4-1. A list of current status messages is provided in the appendix *Status Buffer Messages*.

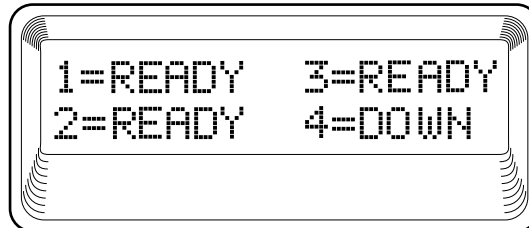

Figure 4-1
Network Connection Status

To quickly and easily configure the ISU 512 for most common applications, see *Quick Setup Configuration* in the chapter *Configuration*.

MENU STRUCTURE

The ISU 512 uses a multilevel menu approach to access its many features. All menu operations are displayed in the LCD window or are available from the VT 100 terminal interface.

The opening menu is the access point to all other operations. There are four Main menu branches: Status, Test, Configuration, and Dial.

Each Main menu item has several functions and submenus to identify and access specific parameters.

Main Menu

There are four branches of the main menu as shown in Figure 4-2.

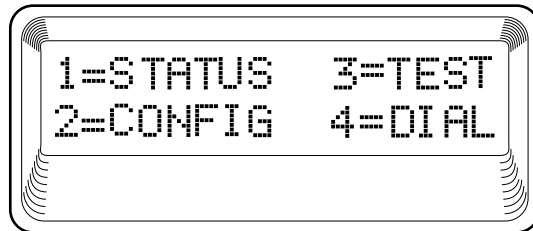

Figure 4-2
LCD Display of the Main Menu

Status Menu

Selecting **1=STATUS** from the top of the menu tree displays the contents of the status buffer. The **Up** and **Down** arrows allow the viewing of the last twenty status messages generated during operation of the unit. (An explanation of Status Buffer Messages can be found in the appendix, *Status Buffer Messages*.) Pressing **0** clears the buffer. Pressing **Cancel** returns to the top of the menu.

Test Menu

Test controls local and remote testing.

Configuration (CONFIG) Menu

Configuration selects network and DTE operating parameters.

Dial Menu

Dial provides manual dialing functions. Key in a number to dial or select one of the ten stored numbers.

Basic Menu Traversal

Four function keys on the left side of the ISU 512 keypad allow the various menu branches to be entered, exited, and scrolled through. The four function keys are defined below:

Enter	Selects flashing menu item.
Up Arrow	Scrolls up the menu tree.
Down Arrow	Scrolls down the menu tree.
Cancel	Exits (back one level) from the current branch of the menu.



NOTE

Function keys are represented in bold, initially capitalized text. Selectable menu items and messages displayed on the LCD are represented in bold type as they appear on the LCD.

To choose an item, press the corresponding number on the keypad. The item flashes on and off to show it is the currently selected (active) choice. Pressing either the **Up** or **Down Arrow** scrolls through the available menu items. Press **Enter** to select the item.

When a command is selected, the ISU 512 issues one of two commands:

Command Accepted	Indicates a successful command processed by the ISU 512.
Command Rejected	Indicates improper configuration attempted. The command is not executed and no configuration change occurs.

The following example illustrates how to select ISU 512 Dial Options:

1. Select Configuration (CONFIG) by pressing **3**, then press **Enter**.
2. Use the **Up** and **Down Arrows** to view submenu items.

3. Choose an item on the submenu such as Network Options (Netw. options) by pressing the corresponding number followed by **Enter**.
4. To select Dial Line options, press **1**, then press **Enter**.

The menu path follows:

3=CONFIG
 1=Netw. options
 1=Dial Line
 4=Dial Options

It is important to note that some features in the ISU 512 do not immediately take effect upon selection. This prevents unintentional reconfiguration of the ISU 512 during an active call. Items such as **Leased/Dial line**, **SPID/LDN**, and **ISDN switch type**, take effect only when the ISU 512 is powered up or the Basic Rate interface is bounced (line broken and restored). Also, items such as **Bit Rate**, **BONDING setup**, and **Call type** take effect only at the beginning of a new call.

FRONT PANEL

Figure 4-3 shows the ISU 512 front panel.

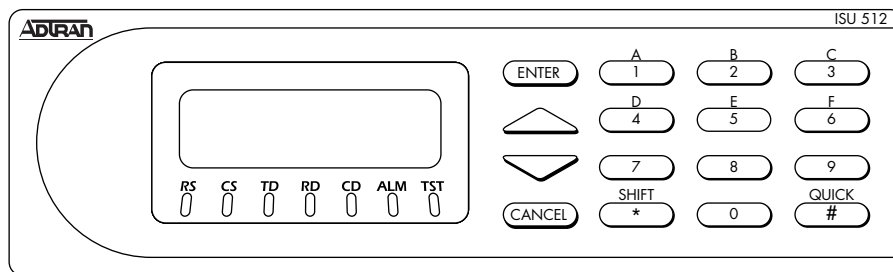

Figure 4-3
ISU 512 Front View

The ISU 512 front panel consists of a 2-line, 16-character LCD display, seven LED indicators, and a 16-button keypad. This allows for configuring, dialing, testing, and monitoring the unit without data terminal or test equipment.

LCD Window

Displays menu items and messages in 2 lines by 16 characters.

Enter

Selects active menu items. To select a menu item, press the number of the item to activate. When the menu item is flashing, press **Enter** to select it. A submenu item is invoked or a configuration parameter is set.

Numeric Keypad

The numeric keypad contains the numbers 0 through 9, which are used to activate menu items and enter parameters.

Cancel

Stops the current activity and returns to the previous menu. Repeat until the desired menu level is reached. When a submenu item is displayed, press **Cancel** to exit the current display and return to the previous menu. Repeat until the desired menu level is reached.

Up and Down Arrows

Up and **Down Arrows** scroll through the submenu items available in the current menu. Submenu items display two at a time in a circular or wrapping fashion. When the submenu items are scrolled, they continuously appear from beginning to end in a forward (**Down Arrow**) or reverse (**Up Arrow**) pattern.

LED Description

The LED indicators monitor data flow and display the status of key DTE interface leads described as follows:

RS	Request to send.
CS	Clear to send. Indicates the ISU 512 is ready to transmit.
TD	Transmit data. On when the DTE is transmitting to the ISU 512.
RD	Receive data. On when the ISU 512 is receiving data from the far end.
CD	Carrier detect. Indicates the ISU 512 is connected to a remote unit.
TR	Terminal ready from DTE. On when DTR is active at DTE interface.
SR	Data set ready.

Chapter 4: Operation

Chapter 5 Configuration

USING ISDN BASIC RATE SWITCHED SERVICE

This section explains how to configure the ISU 512 when using ISDN Basic Rate switched service. Figure 5-1 illustrates the entire Configuration branch of the menu tree.

CONFIGURING NETWORK OPTIONS FOR DIAL OPERATION

This section describes how to configure the ISU 512 for Dial operation such as Switch type, Call type, Terminal ID, Dial options, and Auto answer. To dial calls over ISDN, the ISU 512 must be configured for **Dial Line**.

Switch Type

Find out what kind of ISDN switch the local CO is using by asking the telephone administrator or the telephone company representative. Configure the ISU 512 for either a Northern Telecom DMS-100™, AT&T 5ESS® CO switch, or a switch conforming to the National ISDN-1 standard [usually an AT&T 5ESS, NTI DMS-100, Siemens EWSD, or EuroISDN (CTR3 compliant)]. Outside of North America, use the AT&T 5ESS, NEC, or EuroISDN switch selection.

Use the following menu path:

```

3=CONFIG
  1=Netw. options
    1=Dial Line
      1=Switch Type
        1=AT&T 5ESS (default)
        2=DMS-100
        3=NATIONAL ISDN 1
        4=NEC Switch
        5=EuroISDN (only available on the ISU 512 ST)

```

Call Type

The Call type can be configured four different ways, depending on the type of service used.

Use the following menu to configure the call type:

```

3=CONFIG
  1=Netw. options
    1=Dial Line
      2=Call type
        1=Speech
        2=Audio
        3=Data 56Kbps
        4=Data 64Kbps (default)

```

Speech

Speech directs the call control software to request a Mu-law / A-law speech circuit as the bearer capability for outgoing calls. The Speech option is used with an ISDN line configured for voice service. In some areas voice service costs less than data service. A **Speech** call type does not guarantee an end-to-end digital connection with some local and long distance carriers.

Audio

Audio directs the call control software to request a 3.1 kHz audio circuit as the bearer capability for outgoing calls. The Audio option is used with an ISDN line configured for voice service. In some areas audio service is less expensive than data service. Selecting an **Audio** call type guarantees a digital end-to-end ISDN connection.

Data 56 kbps

Data 56 kbps directs the call control software to request a 64 kbps data circuit that is rate-adapted to 56 kbps. Data 56 kbps is intended for use in circumstances where interoperability with Switched 56 service is desired.

Data 64 kbps (default)

The default Call type for ISDN service is Data 64 kbps. This directs the call control software to request an unrestricted 64 kbps circuit.

Terminal Identification

Terminal identification is assigned by the local telephone company. Use the following menu path to set the terminal identification.

```

3=CONFIG
  1=Netw. options
    1=Dial Line
      3=Terminal ID
        1=Set SPID
        2=Set LDN
  
```

Setting the SPID

The service profile identifier (SPID) is a sequence of digits used to identify ISDN terminal equipment to the ISDN switch. The SPID is assigned by the local phone company when the ISDN line is installed and it usually looks similar to the phone number. Obtain SPIDs from the telephone administrator or local telephone representative.



NOTE

Outside of North America, SPIDs do not have to be entered.

The number of SPIDs required (up to 8) depends on how the ISDN line is configured. For instance, there are no SPIDs for a point-to-point line. Multipoint lines may have one or two SPIDs. The ISU 512 uses the presence of SPID 1 to determine if the line is multipoint. If the line has only one SPID, then it must be entered in SPID 1, SPID 3, SPID 5, and SPID 7, depending on the number of lines being installed.

Use the **Up** and **Down** arrows to select the SPID to enter. SPID numbers correspond to the IFC connector on the rear of the ISU 512 as follows:

IFC #1	SPID 1 (pair with LDN 1) and SPID 2 (pair with LDN 2)
IFC #2	SPID 3 (pair with LDN 3) and SPID 4 (pair with LDN 4)
IFC #3	SPID 5 (pair with LDN 5) and SPID 6 (pair with LDN 6)
IFC #4	SPID 7 (pair with LDN 7) and SPID 8 (pair with LDN 8)

Press **Enter** to select the SPID and use the keypad to enter the SPID number. While keying/editing a SPID, the **Up** arrow allows backspacing through the number string to correct mistakes. The **Down** arrow scrolls back to the last digit entered. To cancel a number, use the **Up** arrow to backspace through the number, then press **Enter**. After entering each SPID, press **Enter**.

Setting the LDN

The local directory number (LDN) is used when placing or receiving BONDING calls. The LDN is the local phone number assigned to the line. This option allows the entry of up to eight LDNs.

Use the **Up** and **Down** arrows to select the LDN to enter. LDNs correspond to the IFC connectors on the rear of the ISU 512 as follows:

IFC #1	LDN 1 (pair with SPID 1) and LDN 2 (pair with SPID 2)
IFC #2	LDN 3 (pair with SPID 3) and LDN 4 (pair with SPID 4)
IFC #3	LDN 5 (pair with SPID 5) and LDN 6 (pair with SPID 6)
IFC #4	LDN 7 (pair with SPID 7) and LDN 8 (pair with SPID 8)

Press **Enter** to select the LDN and use the keypad to enter the LDN number. While keying/editing an LDN, the **Up** arrow allows backspacing through the number string to correct mistakes. The **Down** arrow scrolls back to the last digit entered. To cancel a number, use the **Up** arrow to backspace through the number, then press **Enter**. After entering each LDN, press **Enter**.



NOTE *Disconnect the network interfaces from the unit before initially entering or altering the SPIDs and LDNs.*

If only one SPID is provided for each line, enter the LDN(s) as follows:

IFC #1	LDN 1 and LDN 2 (pair with SPID 1)
IFC #2	LDN 3 and LDN 4 (pair with SPID 3)
IFC #3	LDN 5 and LDN 6 (pair with SPID 5)
IFC #4	LDN 7 and LDN 8 (pair with SPID 7)

Dial Options

The ISU 512 can be configured to dial using the front panel (default), EIA-366 parallel dialing port, or V.25 bis; see Figure 5-2.

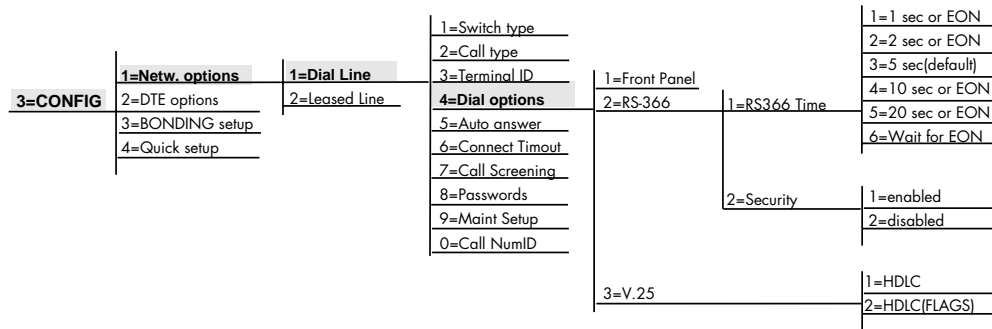

Figure 5-2
Dial Options Menu

Front Panel

To establish and disconnect calls using the front panel, configure **Dial options** for **Front Panel**. See the section *Front Panel* for more details.

RS-366

To establish and disconnect calls using the RS-366 parallel dialing port, configure the unit for RS-366 dialing. This enables the RS-366 port on the rear of the unit. An RS-366 Y cable (part number 1200120L1) is available for dual RS-366 applications such as videoconferencing. DTE RS-366 dialers can end a string of dialed numbers by sending the end of number (EON) to alert the ISU 512 that the entire number has been sent. Another method is to stop sending numbers and allow the ISU to time out, then dial the number. Use the following options to fine-tune the dialed number termination:

1 sec or EON

The ISU 512 assumes the dial string is fully entered if more than 1 second elapses since input of the last digit, or the unit receives the EON command.

2 sec or EON

The ISU 512 assumes the dial string is fully entered if more than 2 seconds elapse since input of the last digit, or the unit receives the EON command.

5 sec or EON (default)

The ISU 512 assumes the dial string is fully entered if more than 5 seconds elapse since input of the last digit, or an EON command is received. This is the factory default setting.

10 sec or EON

The ISU 512 assumes the dial string is fully entered if more than 10 seconds elapse since input of the last digit, or the unit receives the EON command.

20 sec or EON

The ISU 512 assumes the dial string is fully entered if more than 20 seconds elapse since input of the last digit, or the unit receives the EON command.

Wait for EON

The ISU 512 assumes the dial string is fully entered only if the unit receives the EON command.



NOTE

See the section *RS-366 Y Cable* in this chapter for information on enabling the RS-366 Y cable for dual-port video applications.

Security

This option should remain disabled for all normal commercial applications. It is designed for use with only a few specialized military applications and is not described in this manual. For more information on this option, contact ADT-RAN Technical Support (see the inside back cover).

V.25 bis

Configuring the ISU 512 for **HDLC V.25 bis** enables in-band dialing over a DTE interface using standard synchronous HDLC V.25 bis commands with Mark Idle. Configuring the ISU 512 for **HDLC(FLAGS) V.25 bis** enables in-band dialing over a DTE interface using standard synchronous HDLC V.25 bis commands with 7E HEX idle. V.25 bis can be used to establish and end a call. Calls can be disconnected using the front panel, a VT 100 terminal, or from the far-end unit. See *Configuring the ISU 512 for V.25 bis In-band Dialing* in this chapter for more information.

Auto Answer

The ISU 512 can be configured to automatically answer or not answer. Use the following menu path:

```
3=CONFIG
  1=Netw. options
    1=Dial Line
      5=Auto answer
        1=Disabled
        2=Enabled (default)
        3=Dump all calls
```

Disabled

When **Disabled** is selected, the ISU 512 does not answer incoming calls. The ringing call can be dumped using the **Hang Up Line** command. Disable Auto Answer if V.25 bis is in control of answering incoming calls with the **CIC/DIC** commands; other settings override V.25 control of the answer function.

Enabled

When **Enabled** is selected, the ISU 512 accepts incoming calls.

Dump all calls

When **Dump all calls** is selected, the ISU 512 does not accept any incoming calls, keeping the line clear for outgoing calls.

Connect Timeout

The **Connect Timeout** option sets the length of time that the ISU 512 waits for a far-end unit to answer an outgoing call. Use the following menu path:

```
3=CONFIG
  1=Netw. options
    1=Dial Line
      6=Connect Timeout
        1=15 sec
        2=30 sec (def)
        3=1 Minute
        4=2 Minute
        5=4 Minute
```

Call Screening

Call Screening allows the ISU 512 to answer all incoming calls (default) or only calls originating from phone numbers stored in the **DIAL** menu as stored numbers SN0 through SN9. See the section *Dial Options* for reviewing and storing numbers. Use the following menu path to configure Call Screening options:

```
3=CONFIG
  1=Netw. options
    1=Dial Line
      7=Call Screening
        1=Answer any (default)
        2=Answer if SN0..9
```

When **Call Screening** is set to answer any numbers stored in SN0 through SN9, an incoming call is not answered if the Call ID received from the switch does not match a stored number. Depending on the switch type, the Call ID may be presented in either a seven-digit or ten-digit format. The ISU 512 displays the Call ID for all dumped calls in the Status buffer. See the appendix *Status Buffer Messages* for more information on the Status buffer.

Because different switches handle calls and Call ID differently, use the following procedure to determine if your switch uses a seven-digit or ten-digit Call ID format/Call ID (phone number).

1. Select **Ansr if SN0. . 9** under **Call Screening**.
2. Store your multi-digit number in SN0.

3. Place a call to the ISU 512 with the stored number to see if it answers.
4. If the ISU 512 does not answer the call, look at the Call ID message in the Status buffer. More than likely, the Call ID number is a ten-digit number
5. Store the number in SN0 as it is displayed in the Call ID message and test **Call Screening** again.

Remote Access

Remote Download (RDL)

The ISU 512 has the ability to download the contents of Flash Memory (software) to another ISU 512 over a dial-up connection. By using a smart dial string with a #7 suffix, the originating ISU 512 transfers its Flash Memory contents to the remote unit. This allows software updates using only the ISDN connection.

The ISU 512 can be protected from illegal software loads by using the password protection built into the remote protocol. Use the following menu path to access the remote download (RDL) password:

```

3=CONFIG
  1=Netw. options
    1=Dial Line
      8=Passwords
        2=RDL Password
  
```

The smart dial string format for this type of call is as follows:

```
<number>#7#<password>
```

For example, the dial string **9224323#7#1234** would place a remote download call to the remote unit and send the **1234** string as the RDL password. If the remote unit's RDL password is **1234** the request is accepted and the transfer is completed. If the password does not match, the call is terminated by the remote unit. The remote unit places **Inv Password** in the status buffer.

The password may be up to six alphanumeric characters in length. If no RDL password is entered, the unit is unprotected and all attempts to update are accepted.

Remote Supervision

The ISU 512 has the ability to be remotely accessed and configured from another ISU 512. The originating ISU 512 can remotely access another ISU 512 using a smart dial string with a #6 suffix.

The ISU 512 can be protected from illegal access by using the password protection built into the remote protocol. The Supervision (SPV) password can be accessed in the menu tree at:

```
3=CONFIG
  1=Netw. options
    1=Dial Line
      8=Passwords
        1=SPV Password
```

The smart dial string format for this type of call is as follows:
<number>#6#<password>

For example, the dial string **9224323#6#4321** places a remote supervisory call to the remote unit and sends the **4321** string as the SPV password. If the remote unit's SPV password matches the request is accepted. If the password does not match, the call is terminated by the remote unit. The remote unit places **Inv Password** in the status buffer.

During remote SPV, the remote unit can be accessed via the front panel or the VT 100/maintenance port interface. While in remote SPV, the maintenance port prompt changes from the **--512-->** to the **--REM-->** prompt. The VT 100 screens change to signify any configuration changes being passed to the remote unit. The originating unit's configuration is not changed while a remote SPV is in progress.

The password may be up to six alphanumeric characters in length. If no SPV password is entered, the unit is unprotected and all attempts at remote configuration are accepted.

Maintenance Setup

There are three Maintenance Setup options: Auto Traps, ADLP Address, and Port Mode.

Auto Traps

Auto Traps is for use with Port Mode=ATEL. The ISU 512 monitors and reports alarms for network failures or degrading performance conditions. The ISU 512 can be configured to generate protocol traps autonomously by selecting **Enable**. To disable protocol traps, select **Disable**. The ISU 512 sends a trap for the following conditions:

ISDN #1, #2, #3, #4 Link Down

ISDN #1, #2, #3, #4 Link Up

Data Call connected at unexpected data rate. (less than expected)

ADLP Address

Select **ADLP Address** to enter an ADLP address to the ISU 512 as required for use with ADTRAN T-Watch Management Software. This address is used when the ISU 512 maintenance port is programmed for ADLP or ATEL mode.

Port Mode

Port Mode allows the unit to be set for VT 100 terminal or ADLP/ATEL mode for use with ADTRAN T-Watch or ADVISOR SNMP software packages. Selecting **ADLP** allows the ISU 512 to use the ADTRAN Data Link Protocol which is used to send T-Watch commands between the PC and the ISU 512. Selecting **ATEL** allows the ISU 512 to use ADLP/ATEL protocols to communicate with the ADTRAN ADVISOR SNMP software. Select **Terminal Mode** to allow access of the ISU 512 using a VT 100 terminal. Use the following menu path to access Maintenance Setup for Dial Line operation:

```

3=CONFIG
  1=Netw. options
    1=Dial Line
      9=Maint. Setup
        1=Auto Traps
        2=ADLP Address
        3=Port Mode
  
```

Call NumID

When **Call NumID** is enabled, the ISU 512 will send the caller ID INFO setup message to the ISDN switch.

When **Call NumID** is disabled, the caller ID INFO setup message will not be sent to the ISDN switch.

CONFIGURING THE ISU 512 FOR LEASED DIGITAL SERVICE

This section explains how to configure the ISU 512 when using a 2B1Q Leased Digital service or a service that provides a permanent connection between end points. This mode is only supported by the ISU 512 (U interface).

Selecting **Leased Line** configures the unit for leased line service or service that provides a permanent connection between end points such as limited distance modem or LDM service; see Figure 5-3.

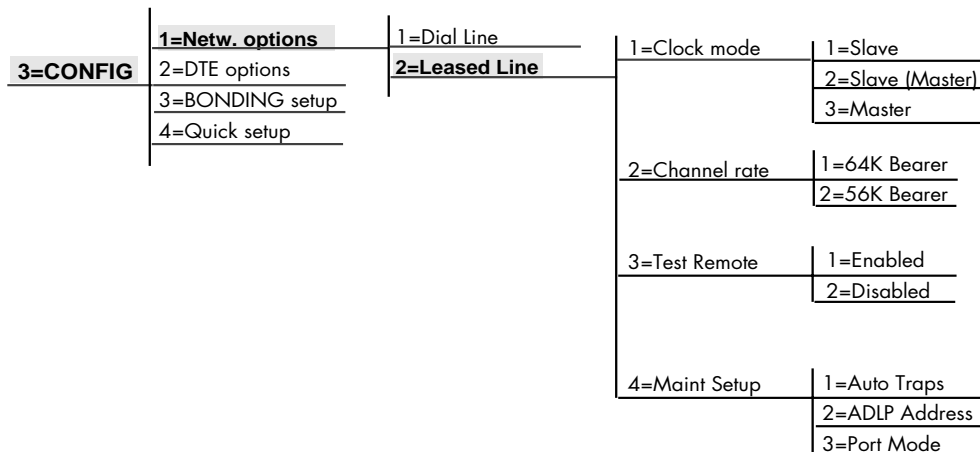

Figure 5-3
Leased Line Menu

Clock Mode

By configuring the ISU 512 for **Master** timing, the ISU 512 can provide clocking for both ends of the phone line. This **Master** option is intended to be used at one end of a limited distance modem application, where two ISU 512 units are directly connected without the use of channel banks; see Figure 5-4. The far-end unit should be configured for **Leased Slave** and it derives its clocking from the ISU 512 configured as **Leased Master** timing.

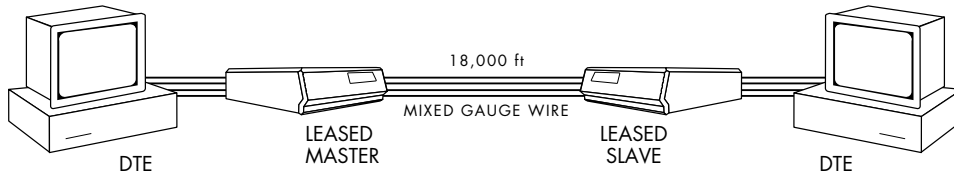

Figure 5-4
Limited Distance Modem Application

If two ISU 512 units are connected through channel banks, one unit should be configured for **Slave** mode and the other for **Slave (Master)**; see Figure 5-5. To easily configure ISU 512s for this application, one unit can be optioned using **Quick Setup, Leased Slave** and the other can be optioned using **Quick Setup, Leased Slave(Master)**. For more information, see the section *Quick Setup Configuration* in this chapter.

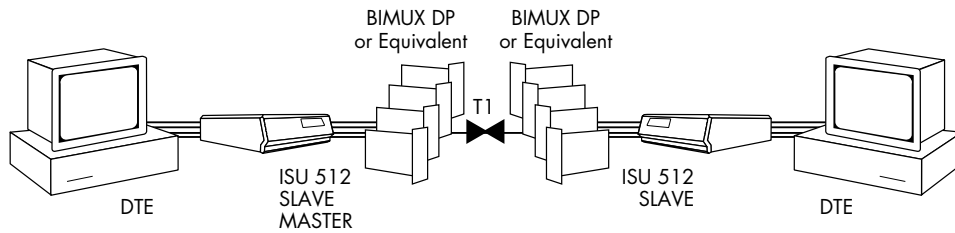

Figure 5-5
Leased Application with Channel Banks

Channel Rate

In **Leased Line** operation, the channel rate for the ISU 512 can be configured for 56 kbps or 64 kbps. When 64 kbps is selected, bandwidth of 1x64 kbps to 8x64 kbps can be selected by setting the maximum bit rate. See *Maximum Bit Rate* in the section *Setting DTE Options* for more information.

Test Remote

When the Test Remote option is enabled the unit performs an automatic 2047 BERT of the line(s) immediately following BONDING connection. When disabled (default), no test is performed after initialization.

Maintenance Setup

There are three Maintenance Setup options: Auto Traps, ADLP Address, and Port Mode.

Auto Traps

The **Auto Traps** option is for use with Port Mode=A TEL. The ISU 512 monitors and reports alarms for network failures or degrading performance conditions. The ISU 512 can be configured to generate protocol traps autonomously by selecting **Enable**. To disable protocol traps, select **Disable**. The ISU 512 sends a trap for the following conditions:

ISDN #1, #2, #3, #4 Link Down

ISDN #1, #2, #3, #4 Link Up

Data Call connected at unexpected data rate. (less than expected)

ADLP Address

Select **ADLP Address** to enter an ADLP address to the ISU 512 as required for use with ADTRAN T-Watch Management Software. This address is used when the ISU 512 maintenance port is programmed for ADLP or A TEL mode.

Port Mode

Port Mode allows the unit to be set for VT 100 terminal (default) or ADLP/A TEL mode for use with ADTRAN T-Watch or ADVISOR SNMP software packages. Selecting **ADLP** allows the ISU 512 to use the ADTRAN Data Link Protocol which is used to send T-Watch commands between the PC and the ISU 512. Selecting **A TEL** allows the ISU 512 to use ADLP/A TEL protocols to communicate with the ADTRAN ADVISOR SNMP software. Use the following menu path to access Maintenance Setup for Dial Line operation:

```

3=CONFIG
  1=Netw. options
    2=Leased Line
      4=Maint. Setup
        1=Auto Traps
        2=ADLP Address
        3=Port Mode
  
```

SETTING DTE OPTIONS

The DTE Options menu is used to select the configuration parameters that control the operation of the DTE interface ports of the ISU 512, such as the maximum bit rate and the connector type. Changes to the DTE options affect both ports (RS-530 and V.35) during dual-port mode and single-port modes of operation.

Maximum Bit Rate

The DTE bit rate can be set for 64K MODE 1 or 56K MODE 1. After selecting the maximum bit rate (**Max Bit Rate**), **64K MODE 1** or **56K MODE 1** blinks to indicate the call type set under network, dial line options. Choosing **64K MODE 1** changes the call type setting to **Data 64kbps**. Choosing **56K MODE 1** changes the call type setting to **Data 56kbps**. After selecting 64K Mode 1 or 56K Mode 1, options are available for selecting multiples of the call type:

- 3=CONFIG
 - 2=DTE options
 - 1=Max Bit Rate
-
- 1=64K Model
 - 1=1x64K
 - 2=2x64K
 - 3=3x64K
 - 4=4x64K
 - 5=5x64K
 - 6=6x64K
 - 7=7x64K
 - 8=8x64K
-
- 2=56K Model
 - 1=1x56K
 - 2=2x56K
 - 3=3x56K
 - 4=4x56K
 - 5=5x56K
 - 6=6x56K
 - 7=7x56K
 - 8=8x64K

Connector Type

Specify the interface by selecting the desired connector type. Use the following menu path to select the connector type.

```

3=CONFIG
  2=DTE options
    2=Connector Type
      1=RS-530
      2=V.35 (default)
  
```

RS-530 to V.35 Cable

The RS-530 to V.35 cable (part number 1200072L1) must be enabled for some dual-port applications, such as videoconferencing. Setting this option to Enabled allows the use of the RS-530 to V.35 cable. This cable converts the RS-530 connector to a V.35 interface. Use the following menu path to enable/disable the RS-530 to V.35 cable.

```

3=CONFIG
  2=DTE options
    3=530-V35 Cable
      1=Enable
      2=Disable (default)
  
```

RS-366 Y Cable

Setting this option to Enabled allows the RS-366 port to use the RS-366 Y cable. The RS-366 Y cable (part number 1200120L1) is used for dual-port video applications. Use the following menu path to enable/disable the RS-366 Y cable:

```

3=CONFIG
  2=DTE options
    4=RS366-Y Cable
      1=Enable
      2=Disable (default)
  
```

CTS Options

Selecting **Forced CTS** causes the CTS signal on the DTE connector to be continually asserted. **Follow RTS** causes the CTS signal to follow the state of the RTS lead. **Follow CD** causes the CTS signal to follow the state of the CD lead. **Off V.25 ANSR** drives CTS off while answering a call with V.25 bis dialing enabled. This setting is used for Panasonic video conferencing equipment with V.25 bis dialing enabled. Use the following menu path to set the CTS options:

```
3=CONFIG
  2=DTE options
    5=CTS Options
      1=Forced CTS (default)
      2=Follow RTS
      3=Follow CD
      4=Off V.25 ANSR
```

CD Options

Selecting **CD Forced on** causes the carrier detect signal to always be asserted. Selecting **Normal** causes the carrier detect signal to be asserted when a call has been successfully established. Selecting **Off Link Down** causes the carrier detect signal to be disasserted when the U-interface is not present. Use the following menu path to set CD options:

```
3=CONFIG
  2=DTE options
    6=CD Options
      1=CD Forced on
      2=Normal (default)
      3=Off Link Down
```

DTR Options

Selecting **Ignore DTR** causes the ISU 512 to disregard the state of the DTR pin. **Idle when Off** forces the unit to end the current call when DTR is no longer asserted. **Off>On dial #0** allows one call attempt to be automatically established when the DTR signal goes from inactive to active. While DTR is active, front panel dialing is also possible. When DTR goes inactive any outgoing call present is disconnected. **Off>On dial #0** uses the phone number in the stored number register 0 to establish the call. Use the following menu path to set DTR options:

```

3=CONFIG
  2=DTE options
    7=DTR Options
      1=Ignore DTR (default)
      2=Idle when Off
      3=Off>On dial #0
      4=Dial #0 if On
      5=Answer if On

```

To store a number for automatic dialing see *Dialing Options*. Selecting **Dial #0 if On** allows calls to be automatically established when the DTR signal is in the active state. The unit attempts to establish a call using SN0-SN4 until the call is established or DTR goes inactive. Selecting **Answer if On** allows the unit to answer an incoming call only if the DTR signal is asserted.



*During dual-port mode, if DTR options is set to **Idle when off**, dropping DTR on the V.35 port terminates both calls; dropping DTR on the RS-530 port terminates only the call on the RS-530 port.*

DSR Options

Selecting **DSR forced on** causes the DSR signal on the DTE connector to always be asserted. Selecting **OFF Idle + Test** causes DSR to be disasserted if the network interface is in test or there is not an active call. **OFF Link Down** causes DSR to be disasserted if the network interface is disrupted. Use the following menu path to set DSR Options:

```

3=CONFIG
  2=DTE options
    8=DSR Options
      1=DSR forced on (default)
      2=OFF Idle+Test
      3=OFF Link Down

```

BONDING SETUP

The ISU 512 communicates with many different types of telecommunication equipment including other ISU 512s, ISDN terminal adapters, Switched 56 DSUs, and BONDING mode 1-compatible inverse multiplexers. The ISU 512 supports the BONDING mode 1 (Bandwidth on Demand Interoperability Group) adaptation protocol.

See *Recommended Operating Protocols* in this chapter for more information on recommended modes of operation.

The BONDING mode 1 protocol allows the ISU 512 to communicate at bit rates in excess of 64 kbps to a maximum of 512 kbps. BONDING provides high-speed communication between ISU 512s, ISDN TE/TAs, and inverse multiplexing equipment supporting the BONDING protocol. The protocol allows use of synchronous bit rates. When the ISU 512 uses the BONDING mode 1 protocol, up to eight separate ISDN phone calls are required to seize control of all ISDN bearer channels. The protocol corrects any delays existing between the bearer channels and presents a single high-speed data channel to the DTE. For successful high-speed operation, both the near and far-end DCE need to be configured to use the BONDING mode 1 protocol. The BONDING mode 1 protocol negotiation phase has numerous timers to allow transmission delays due to satellite hops, international calls, etc.

```
3=CONFIG
  3=BONDING setup
    1=TXINIT
    2=TXFA
    3=TXADD01
    4=TXDEQ
    5=TANULL
    6=TCID
    7=CALL STAGGER
```

TXINIT

This option specifies the length of time the originating endpoint attempts to detect the BONDING negotiation pattern from the answering endpoint before deciding the BONDING call has failed. In general, this timer value should be left at the factory default setting of 10 seconds. Select from values of 1, 2, 5, 10 (default), 20, 50, 100, and 200 seconds.

TXFA

This option specifies the length of time both endpoints attempt to detect the BONDING frame pattern when a call is connected before deciding the BONDING call has failed. This timer value should be left at the factory default setting of 10 seconds. However, when interoperating with other manufacturers' BONDING equipment, it may be necessary to lengthen this timer so that it matches TXADD01. Select from values of 1, 2, 5, 10 (default), 20, 50, 100, and 200 seconds.

TXADD01

This option specifies the length of time both endpoints wait for the additional call to be connected at the end of negotiation before deciding the BONDING call has failed. The factory default setting of 50 seconds is sufficient for most calls to connect, although when dialing overseas it may be necessary to lengthen this timer to allow for slower call routing. Values of 1, 2, 5, 10, 20, 50 (default), 100, and 200 seconds can be selected.

TXDEQ

This option specifies the length of time both endpoints attempt to equalize the network delay between the bearer channels before deciding the BONDING call has failed. This timer default setting is 50 seconds. Values of 1, 2, 5, 10, 20, 50 (default), 100, and 200 seconds are available.

TANULL

This option specifies the length of time the answering endpoint attempts to detect the BONDING negotiation pattern from the originating endpoint before aborting to clear channel mode. In general, this timer value should be left at the factory default setting of 10 seconds. However, it may be necessary to shorten this timer if the DTE equipment connected to the ISU also has timer constraints for completing non-BONDING parameter negotiation. Values of 1, 2, 5, 10 (default), 20, 50, 100, and 200 seconds can be selected.

TCID

This option specifies the length of time both endpoints attempt to negotiate an agreeable value for bearer channels and channel capacities before deciding the BONDING call has failed. This timer default setting is 5 seconds. Values of 1, 2, 5 (default), 10, 20, 50, 100, and 200 seconds can be selected.

Call Stagger

This option specifies the amount of delay placed between calls. The default setting is 0 ms (no delay). Values of 0 ms (default), 100 ms, 200 ms, 500 ms, 1 second, and 2 seconds can be selected.

TRANSPARENT 2 X CLEAR CHANNEL PROTOCOL

Due to the large number of existing videoconferencing circuits that utilize dual-port terminal adapters or two SW56 DSU/CSU units, the ISU 512 has been designed to operate with these existing circuits by using a transparent 2x56/64 Clear Channel protocol. During incoming and outgoing calls, the ISU 512 attempts BONDING mode 1 protocol first. If the BONDING protocol fails to negotiate with a far-end unit supporting the BONDING protocol, the ISU 512 automatically attempts 2 x Clear Channel protocol. During this mode, the first connected call (incoming or outgoing) is attached to the primary port (V.35 connector) and 56 kbps or 64 kbps data rate is used depending on the Call Type used during the call placement or acceptance. Front panel display reads 1x56/64. The second call, (answered or initiated) is attached to the RS-530 port (an RS-530 to V.35 cable adapter, part number 1200072L1 is available) and reads 2x56/64.

The second call is dialed using the front panel, the VT 100 terminal interface, or by using the RS-366 port. By using an RS-366 Y cable adapter (part number 1200120L1), the single RS-366 port on the back of the ISU 512 can be converted to two ports. The RS-366 Y cable connects to the single RS-366 port on one end and has two connectors for the dual ports required on videoconferencing equipment. The cable should be enabled from the front panel interface or through the VT 100 menu screen. The cable has one connector labeled **PRI-MARY**. This primary connector places the call for the primary port, the V.35 connector. The other RS-366 connector is used to dial the RS-530 port. A call must currently be active on the primary port before the second call can be placed. This ensures the first call does not connect with a unit supporting the BONDING protocol. For example, if a call is placed through the primary RS-366 connector, and the ISU 512 connects to a unit on the other end that supports the BONDING protocol, then BONDING places the remaining calls automatically. If the ISU 512 does not find a unit at the other end that supports BONDING, the ISU 512 keeps the first call active, and automatically uses 2 x Clear Channel Protocol. The second call placed through the secondary RS-366 connector connects on the RS-530 port.



If the ISU 512 is to be used in the application described, then the RS-366 Y cable should be enabled and the connector type for the DTE port should be set to the primary port, the V.35 port. An RS-530 to V.35 cable adapter (part number 1200072L1) can be used to adapt the RS-530 port to an existing V.35 interface when required.

Videoconferencing equipment should be set for *delayed second call* dialing when using the RS-366 Y cable for dialing 2-clear channel calls.

QUICK SETUP CONFIGURATION

To configure the DTE Options quickly and easily, the Quick Setup menu is available to automatically set up the eight most common DTE configurations. For fine-tuning a particular application and DTE settings, the section *Setting DTE Options* in this chapter provides a step-by-step process for detailed configuration of the DTE Options.

To aid in configuring the DTE options for the ISU 512, many common configurations are preset for **Quick Setup**. These include various dial, leased, and video options. Use the following menu path to access Quick Setup options:

```
3=CONFIG
  4=Quick setup
    1=Dial 512K
    2=Dial 384K
    3=Dial 448K
    4=Dial 336K
    5=Video 384K
    6=Video 336K
    7=Leased Slave
    8=Leased Master
    9=Ldm SlvMstr
```

Dial 512K

When the ISU 512 is configured for **Dial 512K** service the following parameters are automatically preset:

Service type	ISDN dial line
Automatic answering	Enabled
ISDN call type	64 kbps data
Dial options	Front Panel
Maximum bit rate	512 kbps
DTR options	Ignore
RS-530-V35 cable	Disabled
RS-366-Y cable	Disabled

Dial 384K

When the ISU 512 is configured for **Dial 384K** service the following parameters are automatically preset:

Service type	ISDN dial line
Automatic answering	Enabled
ISDN call type	64 kbps data
Dial options	Front panel
Maximum bit rate	384 kbps
DTR options	Ignore
RS-530-V35 cable	Disabled
RS-366-Y cable	Disabled

Dial 448K

When the ISU 512 is configured for **Dial 448K** service the following parameters are automatically preset:

Service type	ISDN dial line
Automatic answering	Enabled
ISDN call type	56 kbps data
Dial options	Front panel
Maximum bit rate	448 kbps
DTR options	Ignore
RS-530-V35 cable	Disabled
RS-366-Y cable	Disabled

Dial 336K

When the ISU 512 is configured for **Dial 336K** service the following parameters are automatically preset:

Service type	ISDN dial line
Automatic answering	Enabled
ISDN call type	56 kbps data
Dial Options	Front panel

Maximum bit rate	336 kbps
DTR Options	Ignore
RS-530-V35 cable	Disabled
RS366-Y cable	Disabled

Video 384K

When the ISU 512 is configured for **Video 384K** the following parameters are automatically preset:

Service type	ISDN dial line
Automatic answering	Enabled
ISDN call type	64 kbps data
Dial options	RS-366
Maximum bit rate	384 kbps
DTR options	Idle when Off
RS-530-V35 cable	Enabled
RS-366-Y cable	Enabled

Video 336K

When the ISU 512 is configured for **Video 336K** the following parameters are automatically preset:

Service type	ISDN dial line
Automatic answering	Disabled
ISDN call type	56 kbps data
Dial options	RS-366
Maximum bit rate	336 kbps
DTR options	Idle when Off
RS-530-V35 cable	Enabled
RS-366-Y cable	Enabled

Leased Master

When the ISU 512 is configured for **Leased Master** the following parameters are automatically preset:

Service type	Leased Line
Automatic answering	Enabled

Maximum bit rate	512 kbps data
DTR options	Ignore
Clock mode	Master
Channel rate	64K Bearer
RS-530-V35 cable	Disabled
RS-366-Y cable	Disabled

Leased Slave and Ldm SlvMstr

When the ISU 512 is configured for **Leased Slave** or **Ldm SlvMstr** (limited distance modem slavemaster) the following parameters are automatically preset:

Service type	Leased Line
Automatic answering	Enabled
Maximum bit rate	512 kbps
DTR options	Ignore
Clock mode	Slave
Channel rate	64K Bearer
RS-530-V35 cable	Disabled
RS-366-Y cable	Disabled

DIALING OPTIONS

Selecting **4=DIAL** or pressing the # (pound) from the top of the menu tree displays the available dialing options. (See Figure 5-3.) Use the following menu path to set dialing options:

- 4=Dial
 - 1=Hang up line
 - 2=Dial number
 - 3=Redial last #
 - 4=Answer Call
 - 5=Dial stored #
 - 6=Store/Review #

Hang Up Line

Terminates current call.

Dial Number

Allows a number to be entered and dialed from the key pad. If an error is made while entering a number, press **Cancel** to erase and reenter the number. Press **Cancel** twice consecutively to exit without dialing a number. Press **Enter** after entering a number to dial the number and save the dialed number as stored number 9 for redialing purposes.

Redial Last Number

Allows redial of the last number called or attempted. This number was saved as stored number 9 from the last attempted phone call.

Answer Call

Allows selective answer of incoming calls when the Auto Answer is configured for disable. Auto Answer is described in *Auto Answer* in this chapter.

Dial Stored Number

Allows the dialing of one of ten stored phone numbers. Upon entering this menu, the **Up** and **Down** arrows permit viewing and selection of a stored number. Press **Enter** to dial the number. A copy of that number is saved as stored number 9 (SN9) for redial purposes.

Store/Review Number

Enter and review stored numbers. Press the **Up** and **Down** arrow keys to scroll through the 10 stored numbers (SN0 - SN9). To store a number, scroll in the desired stored number location, enter the number, and press **Enter** to save. If a mistake is made, press **Cancel** to clear the line and allow another attempt. Press **Cancel** twice in succession to exit without changing the selected stored number.

CONFIGURING THE ISU 512 FOR V.25 BIS IN-BAND DIALING

V.25 bis dialing is used primarily by data terminal equipment with synchronous interfaces (HDLC/SDLC or BSC/BISYNC) not supporting the AT command set, which is commonly used by asynchronous devices. The ISU 512 supports V.25 bis in-band dialing in accordance with Fascicle VIII.I - V.25 bis (Malaga-Torremolinos 1984, Melbourne 1988).

Recommendation V.25 uses the following DCE/DTE control signals:

Transmitted data	Circuit 103
Received data	Circuit 104
Ready for sending	Circuit 106
Data set ready	Circuit 107
Data terminal ready	Circuit 108/2
Calling indicator	Circuit 125

The ISU 512 supports the following V.25 bis commands to control automatic calling and answering:

CRN	Call request (number in command)
CRS	Call request (using stored number)
PRN	Program stored number
RLN	List stored number
CIC	Connect incoming call
DIC	Disconnect incoming call



NOTE

*When using stored numbers, V.25 bis accesses stored numbers 1 through 9 used by front panel dialing. See **Dialing Options** (in this chapter).*



NOTE

Auto answer should be disabled if V.25 bis is in control of answering incoming calls with the CIC/DIC commands, since the other settings for Auto answer will override V.25 control of the answer function.

Chapter 6 Testing

TEST OPTIONS

Selecting **2=TEST** from the Main menu tree displays available local testing options. Use the following menu path to select test options:

```
2=Test
  1=Loopback DTE
  2=Loopback Proto
  3=2047 Checker
  4=NEBE/FEBE
  5=Software Ver
```

Loopback DTE

Causes both DTE ports to loopback toward user equipment. This allows performance of a bit error rate test (BERT) between the ISU 512 and end user equipment to verify proper cable connection, etc.

Loopback Protocol

Allows data to be looped back toward the network after passing through BONDING protocol. See Figure 6-1 for loopback points.

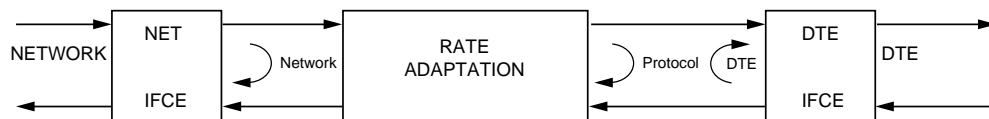

Figure 6-1
ISU 512 Loopback Points

2047 Checker

The ISU 512 has the ability to loopback the remote unit and generate/check 2047 BERT pattern through the BONDING protocol. This allows 2047 BERT patterns to be run on multiple ISDN connections (through BONDING). The originating ISU 512 generates the 2047 patterns and checks the incoming pattern for errors. The test is run for a period of time defined in S-register 26. The larger the value in S26 the longer the test runs before entering data mode. The results of the test are placed in the status buffer of the originating unit.

The Smart Dial String Format for this type of call is:

<number>#5

For example, the dial string 9224323#5 places a remote loopback call to the remote unit. After BONDING connects, the originating unit displays the byte count and error count for the current test along with the amount of time left in the test. The remote unit remains in protocol loopback and displays the amount of time left before the unit(s) enter data mode. This allows the originate side to complete the test and write the results to the status buffer.

Pressing **0** clears the counts. Pressing **Cancel** ends the test.



*Pressing **Cancel** on the Remote unit before the end of the test causes the Originate unit to receive errors and terminate the test. Pressing **Cancel** on the Originate unit before the end of the test does not terminate the test at the Remote Site.*

Near-End Block Errors/Far-End Block Errors (NEBE/FEBE)

Allows the user to monitor the quality of the local loop by viewing the number of near-end block errors (NEBE) and far-end block errors (FEBE) occurring on the ISDN U-interface. An incrementing count of NEBEs indicates a problem on the local loop from the switch to the NT-1. An incrementing count of FEBEs indicates a problem on the local loop from the NT-1 to the switch. A call does not have to be placed to use the NEBE/FEBE counter.

**NOTE**

Since this is a function of the U interface, it only applies to the ISU 512 with U interface.

Software Version

Allows determination of the software version in use on the ISU 512.

Pressing **Cancel** exits any of these options.

Chapter 6: Testing

Chapter 7

Troubleshooting

IF SELF TEST FAILS

When the ISU 512 powers up, it performs an internal self test. This takes approximately 10 seconds. At the end of the test, the front panel displays **Self Test Passed**. If **Self Test Passed** is not displayed, perform the following procedure to verify if the problem can be solved locally:

1. Ensure the ISU 512 is receiving power and is switched *On*.
2. Turn *Off* the ISU 512; while holding the **0** key, power up the ISU 512. Continue holding **0** for approximately 30 seconds, until the unit powers up. This resets all the internal settings to factory defaults and erases SPID and LDN information.
3. If the ISU 512 still does not pass Self Test, call ADTRAN Technical Support; see the inside back cover of this manual.

IF AN ISDN NETWORK LINE READS DOWN



If EuroISDN switch type is selected and the front panel displays DOWN, it is only an indication that a call has not been placed to activate the line.

When the ISU 512 has been set up, connected to ISDN lines, and the front panel displays **DOWN** for any of the network ISDN lines, use the following troubleshooting procedure:

1. Cycle power on the ISU 512, leaving it *Off* for a minimum of 2 seconds.
2. If **Ready** is not displayed after waiting another full minute, disconnect the ISU 512 from the ISDN line. Using a functioning voice phone, call the local

directory number(s) provided with the ISDN line. Calling a good ISDN line with nothing connected usually results in a ring or fast busy tone. If the call is completed or a not-in-service intercept is received, then there is probably something wrong with the translation of the ISDN line. Contact the phone service provider for help.

3. If the ISU 512 continues to read **DOWN**, there is a physical problem with the ISDN line (probably Layer 1 setup). The problem is one or more of the following:
 - The ISU 512 software setup
 - The ISU 512 hardware
 - CPE wiring
 - Wiring from the telephone service provider
 - Hardware of the telephone service provider
 - Software setup of the telephone service provider

To isolate the problem, perform the following procedure:

- A. Ensure the ISDN line is plugged into the correct IFC connector on the back of the ISU 512.
- B. Ensure the ISU 512 is configured for Dial Line service. **CONFIG, Netw. options,** and **Dial Line** should be selected from the menu.
- C. Connect another piece of functioning ISDN equipment to the ISDN line.
- D. Contact the service provider and ensure you have an ISDN Basic Rate U-Interface with 2B1Q line coding (wrong options are an S or T interface or AMI line coding). For the ISU 512 (ST), the S or T interface option would be correct.
- E. Ensure the ISDN phone lines are connected to the actual ISDN telephone line (Basic Rate interface) provided by the telephone company. Ensure the ISDN line is not connected through another piece of equipment in a wiring closet.

-
- F. Ensure nothing else is bridged across the ISDN line pair.
 - G. With a minimum of extra wiring, try connecting to the line pair at the point where service provider's wiring ends.
 - H. With the ISU 512 connected to the ISDN line and powered up, contact and inform the service provider's repair group that your ISDN basic rate line has a Physical Layer 1 problem. Request the ISDN line be checked.

IF THE DISPLAY READS TEI1

If the ISU 512 reads **TEI1**, then the ISU 512 is physically connected to the local telephone service provider but is unable to establish Logical Layer 2. The problem is in one or more of the following places:

- The ISU 512 software setup
- The telephone service provider's software setup
- Hardware configuration if the line is extended from the switch

To isolate the problem, use the following procedure:

1. Ensure the ISU 512 is set up for the correct switch type by selecting **CONFIG, Netw. options, Dial Line**, and **Switch type**.
2. Ensure ISDN line quality is satisfactory by checking for near- and far-end block errors (NEBEs and FEBEs) by selecting **Test, NEBE/FEBE**.



*NEBE/FEBE count may indicate a non-zero number during test initialization. Press **0** and wait for several minutes.*

If the counts are non-zero, there may be a physical link problem (probably Layer 1 setup) caused by one or more of the following:

- The ISU 512 software setup
- The ISU 512 hardware
- CPE wiring
- Wiring from the telephone service provider
- Hardware of the telephone service provider
- Software setup of the telephone service provider

3. Connect another piece of functioning ISDN equipment to the ISDN line.
4. With the ISU 512 connected to the ISDN line and powered up, talk to your service provider's repair group and tell them you have an ISDN basic rate line that appears physically OK but has no terminal endpoint identifier (TEI). Ask them to check the line translation and ensure that ISDN the line supports Dynamic TEI allocation. Tell them that you have an NT1 and terminal adapter device connected to the ISDN line.

IF THE DISPLAY READS TEI2



Outside of North America, only one TEI is usually assigned per basic rate line.

If the ISU 512 continues to read **TEI2**, the ISU 512 has completely initialized the first phone number but is unable to establish Logical Layer 2 for the second phone number. The problem is in one or more of the following places:

- The ISU 512 software setup
- The software setup of the telephone service provider

To isolate the problem, use the following procedure:

1. Make sure that the ISU 512 is set up with the correct SPID and LDN by selecting **CONFIG, Netw. options, Dial Line, Terminal ID, and SPID/LDN**.
2. Try swapping SPID1 with SPID2 and LDN1 with LDN2, SPID3 with SPID4 and LDN3 with LDN4, SPID5 with SPID6 and LDN5 with LDN6, and SPID7 with SPID8 and LDN7 with LDN8. Determine if the problem is the second phone number or the quantity of phone numbers.
3. Connect another piece of functioning ISDN equipment to the ISDN line.
4. With the ISU 512 connected to the ISDN line and powered up, talk to your service provider's repair group and inform them you have an ISDN basic rate line that appears physically OK but has no Terminal Endpoint Identifier (TEI). Ask them to check the ISDN line translation and ensure that the ISDN line supports dynamic TEI allocation. Inform them an NT1 and terminal adapter device are connected to the ISDN line.

IF THE DISPLAY READS SPID{1,3,5, OR 7}

**NOTE**

This section does not apply to installations outside of North America.

If the ISU 512 reads **SPID1**, then the ISU 512 is physically connected to the local telephone service provider and has established Logical Layer 2. The ISU 512 is unable to establish layer 3. The problem is with one or more of the following:

- The ISU 512 software setup
- The software setup of the telephone service provider

To isolate the problem, use the following procedure:

1. Ensure the ISU 512 is set up for the correct switch type by selecting **CONFIG, Netw. options, Dial Line**, and **Switch type**.
2. Ensure that the ISU 512 is set up with the correct SPID and LDN by selecting **CONFIG, Netw. options, Dial Line, Terminal ID**, and **SPID/LDN**. Review the section *Setting the SPID* in the chapter *Configuration*.
3. Connect another piece of functioning ISDN equipment to the ISDN line.
4. With the ISU 512 connected to the ISDN line and powered up, talk to your service provider's repair group and inform them you have an ISDN basic rate line that appears physically OK but has no Terminal Endpoint Identifier (TEI). Ask them to check the ISDN line translation and ensure that the line supports dynamic TEI allocation. Inform them an NT1 and terminal adapter device are connected to the ISDN line.

IF THE DISPLAY READS SPID{2,4,6, OR 8}

**NOTE**

This section does not apply to installations outside of North America.

If the ISU 512 continues to read **SPID2**, the ISU 512 has completely initialized the first phone number but is unable to establish Logical Layer 3 for the second phone number. The problem is with one or more of the following:

- The ISU 512 software setup
- The software setup of the telephone service provider

To isolate the problem, perform the following procedure.

1. Ensure the ISU 512 is set up with the correct SPID and LDN by selecting **CONFIG, Netw. options, Dial Line, Terminal ID**, and **SPID/LDN**.
2. Try swapping SPID1 with SPID2 and LDN1 with LDN2, SPID3 with SPID4 and LDN3 with LDN4, SPID5 with SPID6 and LDN5 with LDN6, and SPID7 with SPID8 and LDN7 with LDN8. Determine if the problem is the second phone number or the quantity of phone numbers.
3. Connect another piece of functioning ISDN equipment to the ISDN line.
4. With the ISU 512 connected to the ISDN line and powered up, talk to your service provider's repair group and inform them you have an ISDN basic rate line that appears physically OK but has no Terminal Endpoint Identifier (TEI). Ask them to check the ISDN line translation and ensure that the line supports dynamic TEI allocation. Inform them an NT1 and terminal adapter device are connected to the ISDN line.

Chapter 8

Specifications Summary

SPECIFICATIONS AND FEATURES

This section describes the standard specifications and features incorporated in the ISU 512.

Network Interface

Four RJ-45s for ISDN Basic Rate Interface

DTE Interface

RS-530 or V.35 (both connectors present)

Dialing Selections

- Manual or automatic stored number dialing, DTR assertion
- V.25 bis in-band DTE dialing
- RS-366 dial interface
- VT 100 menu interface

Data Rates

- Network: up to four BRIs (maximum of eight 56/64 kbps B channels)
- DTE: 56 kbps to 512 kbps synchronous

Rate Adaption

- BONDING mode 1
- 2 x Clear Channel, dual port Clear Channel

Interoperability

- BONDING inverse multiplexers
- Switched 56 DSUs
- ISDN TAs

D Channel Switch Compatibility

- AT&T 5ESS
- NTI DMS-100
- National ISDN-1
- EuroISDN (only available on the ISU 512 ST)

B Channel Aggregation

BONDING protocol Mode 1

Display

Two-line x 16-character LCD

Environmental

- Operating temperature: 0 to 50 °C (32 to 122 °F)
- Storage temperature: 20 to 70 °C (- 4 to 158 °F)
- Relative humidity: Up to 95%, non-condensing

Physical

2.25" H, 8.75" W, 11.00" D

Power

90-250 VAC, 50-60 Hz, 8-15, 5W maximum dissipation

Appendix A

Status Buffer Messages

STATUS LINE MESSAGES

Messages in all caps are generated by the ISDN network. Messages with lower case letters are generated by the ISU 512.

Call Connect B1

Bearer channel 1 connected and is currently active.

Call Connect B2

Bearer channel 2 connected and is currently active.

NET REM LOOPBACK

The ISU is performing a V.54 or DDS latching loopback toward the network.

Disconnecting

The current phone call is being disconnected (hung up).

LPBK DTE Port

The DTE connector is looped back in the DTE direction.

{1,2,3,4}:TEI1

The ISU is receiving the first Terminal Endpoint Identifier (TEI) from the network.

{1,2,3,4}:TEI2

The ISU is getting its second TEI from the network.

{1,2,3,4}:down

The network interface is not active.

{1,2,3,4}:NEOC

The ISU has been commanded to perform an ISDN loopback toward the network.

{1,2,3,4}:SPID1

The ISU is registering its first SPID with the network.

{1,2,3,4}:SPID2

The ISU is registering its second SPID with the network.

RINGING

The phone number just dialed is ringing.

BONDING nnnn

BONDING mode 1 rate adaption is running at the bit rate specified by nnnn.

BONDING Quitting

BONDING mode 1 rate adaption protocol is turning off.

BONDING Ready

BONDING mode 1 rate adaption protocol is ready.

BONDING Setup

BONDING mode 1 rate adaption protocol is setting up.

LPBK Netw. Side

The ISU 512 is in a customer initiated loopback.

{1,2,3,4}:Sync

The ISU 512 has successfully activated to the network but is still waiting for the switch to issue the ACT bit.

CALL xxxxxxxx

The ISU is calling phone number xxxxxxxx.

{1,2,3,4}:Ready

The ISU 512 is connected to an AT&T 5ESS switch and is ready to place/receive calls.

{1,2,3,4}:PLBBK

The ISU has been commanded to perform a loopback in the network direction after letting the incoming data pass through the current protocol.

Answer {1,2,3,4,5,6,7,8}

The ISU answered a call on either the first or second channel. The calling phone number is displayed if available.

ACCESS_INFO_DISC

The network was unable to deliver access information to the far end.

Bad AT bit field

User issued an AT command with an argument that was out of range.

Bad call type

ISU 512 placed a call with an improper call type.

Bad DTE baud

The DTE bit rate does not match a valid bit rate for the protocol selected.

Bad DTE bps

Bonding negotiation determined that the chosen DTE bit rate is invalid.

BAD_INFO_ELEM

Call control error.

Bad phone number

ISU 512 attempted to call an invalid phone number.

BEAR_CAP_NOT_AVA

The bearer channel requested by the user is not available.

Bearer mode

Incoming call is not of a type the ISU 512 can accept.

Bearer info mode

Incoming call information transfer capability is not known.

BONDING (+/- XXX)

The amount of bytes of corrected delay between the B2 and B1 Bearer channels (XXX can range from -8000 to +8128 bytes).

BPS mismatch

Bonding negotiation found a bit rate mismatch.

BUSY

The called number is busy.

CallID 1 in use

ISU 512 tried to place a call using SPID 1 though SPID 1 was already in use.

CallID 2 in use

ISU 512 tried to place a call using SPID 2 though SPID 2 was already in use.

Call not ringing

User executed an answer command (A) but there was not a call present.

CALL_REJECTED

The call has been rejected by the ISDN Network.

CAP_NOT_IMPLEMENT

The network or far end does not support the bearer capability requested.

CHAN_DOES_NOT_EXI

The user asked for a bearer channel that is not present.

CHAN_NOT_IMPLME

The bearer channel requested by the user has not been implemented.

CHANNEL_UNACCEPT

The user is asking for a channel that has not been subscribed.

CID>0 rcvd

Received an incoming call from a third party during negotiations with a far end BONDING unit on the use of the second Bearer channel.

DEST NOT ISDN

The number called is not ISDN (warning only).

DEST_OUT_OF_ORDER

The called number is out of order.

Dial{1,2,3,4,5,6,7,8}

The ISU 512 placed a call on either the first or second channel. The number called is displayed following the message.

Discon{1,2,3,4,5,6,7,8}

The call on either the first or second channel was disconnected from the network. The far-end phone number is displayed if available.

Disconnect Req

Far-end unit disconnected during BONDING negotiation.

DPUMP END RCVD

Indication of a hang-up or disconnect occurring during BONDING. Does not indicate an ERROR condition has occurred.

DTE not set V25

The DTE equipment is not optioned for the same bit rate as the ISU 512 for V.25 bis dialing.

DTR not up

ISU 512 tried to place a call in a dialing mode that requires DTR to be in an active state but it is not.

Dump call

ISU 512 could not accept an incoming call because it was already involved in a call.

Dump{1,2,3,4,6,7,8}

An incoming call on either the first or second channel was discarded by the ISU. The calling number is displayed if available.

FACILITY_NOT_IMP

The network does not support the requested supplementary service.

FACILITY_REJECTED

A facility requested by the user cannot be provided by the network.

FACILITY_NOT_SUB

The channel type requested has not been subscribed by the user.

FBW Disconnect

BONDING negotiation failed due to a disconnect on a B-Channel.

Hangup1/2

The call on either the first or second channel was disconnected by the ISU. The far-end phone number is also displayed.

Hardware Rev. F

The ISU 512 has a Revision F network daughterboard.

Hardware Rev. H

The ISU 512 has a Revision H network daughterboard.

INCOMING_CALL_BA

Incoming call barred. The network will not allow an incoming call.

INCOMPATIBLE_DEST

The called number cannot accept the type of call that has been placed.

INTRWORKING_UNSP

A message was sent by a far-end network that was not understood.

INVALID_CALL_REF

Call control error.

INVALID_ELEM_CON

Call control error.

INVALID_MSG_UNSP

Invalid message, protocol error.

INVALID_NUMBER_F

The dialed number has an invalid format.

L1 not up

The network interface is not active.

L2 not up

The data link layer interface is not active.

L3 not up

The call control interface is not active.

L2 #{1- 8} not up

The data link layer interface for the call number shown (BONDING) is not active.

L3 #{1- 8} not up

The call control layer interface for the call number shown (BONDING) is not active.

LDN TOO LONG

The entered Local Directory Number has too many digits.

MANDATORY_IE_LEN

Mandatory information element length error.

MANDATORY_IE_MIS

Mandatory information element missing.

Need 64K call

The BONDING protocol requires the ISU 512 to be configured for a 64k data call type.

Negotiation fail

The BONDING negotiation has failed.

NETWORK BUSY

The ISDN switch is busy and unable to process a call.

NETWORK_CONGESTI

The phone network is currently congested.

NETWORK_OUT_OF_O

The phone network is out of order.

NO_CIRCUIT_AVAIL

The requested bearer channel is not available.

NONEXISTENT_MSG

Nonexistent message was sent by the ISU.

No Sreg number

User attempted to access an S-register but did not specify an S-register (example: S=1).

No Sreg value

User attempted to change an S-register but did not specify a value (example: S2=).

NO_ROUTE

The phone network was unable to find a route to the destination number.

NO 2x64/56

2 x Clear Channel mode failed. The RS-530 port is set to primary. This is an invalid configuration for using 2 x Clear Channel mode.

NO_USER_RESPONDI

The dialed number is not responding.

NORMAL_CLEARING

The network is disconnecting the current call.

NOT end2end ISDN

The path that the call was routed over is not ISDN from end-to-end (warning only).

NUMBER_CHANGED

The number dialed has been changed.

OUTGOING_CALL_BA

The network will not allow the outgoing call to be placed.

PRE-EMPTED

The network pre-empted the call.

PROTOCOL_ERROR

Call control error.

REQ_CHANNEL_NOT_

The channel type requested is currently not available.

Remote not ISU

Bonding negotiation determined the far-end unit is not another ISU 512.

RESP_TO_STAT_ENQ

Response to status enquiry.

Ring 1/2

An incoming call on either the first or second channel entered the Ring state. The calling phone number is displayed if available.

S cmd not = or ?

User did not use proper syntax in the command string.

SERVICE_NOT_AVAIL

The service requested by the user is not available.

SOURCE NOT ISDN

The incoming calling party is not ISDN (warning only).

SReg SetError

Local DTE invalid S-register setting.

TANULL expired

Bonding timer TANULL expired; non BONDING equipment attempted to call into the ISU 512 while optioned for BONDING.

TEMPORARY_FAILURE

The network has temporarily failed; try the call again.

TIMER_EXPIRY

Call control error.

TXADD01 expired

Bonding timer TXADD01 expired, probably making a long distance call to a foreign country; adjust timer value to correct.

TXFA1 expired

Bonding timer TXFA1 expired; other vendor's BONDING equipment did not operate properly.

TXFA2 expired

Bonding timer TXFA1 expired; other vendor's BONDING equipment did not operate properly.

TXINIT expired

Bonding timer TXINIT expired; called non-BONDING equipment.

UNASSIGNED_NUMBER

The phone number dialed does not exist.

Unknown AT & cmd

User issued an unknown AT command.

UNSPECIFIED_CAUSE

Received a cause message from the network that is not understood.

USER_BUSY

The dialed number is busy.

WRONG_MESSAGE

The ISU 512 received a message that does not match the valid messages defined for the switch.

WRONG_MSG_FOR_ST

The ISU 512 received a message that is not appropriate for the state of the call.

530 Set Primary

The connector type is set to RS-530. This may cause 2 x Clear Channel mode to fail to come on-line. 2 x Clear Channel mode only works when the connector type is set to V.35.

Appendix B

S-Register List

- S0 AUTO ANSWER Determines how the ISU 512 answers an incoming call.
0=Disable (ISU 512 does not answer call)
1=Enable (ISU 512 answers all calls) (default)
2=Dump all calls
- S7 CONNECT TIME Determines how long the ISU 512 waits for an outgoing call to be answered.
15=15 seconds
30=30 seconds (default)
60=1 minute
120=2 minutes
240=4 minutes
- S26 2047 Test Time Determines the amount of test time to allocate for a remote 2047 test. This number is approximately in 1 minute increments.
0 to 255 (**2 min is default**)
- S32 DTE DSR Controls the operation of the Data Set Ready signal on the DTE connectors.
0=Force DSR on always
1=DSR active only during a call
2=DSR active only when network interface is on
- S33 DTE CD Controls the operation of the Carrier Detect line on the DTE connectors.
0=Force CD on always
1=CD is active during a call
2=LOCD
3=Off Link Down

Appendix B. S-Register List

- S34 ...DTE DTR.....Determines how the ISU 512 responds to changes in DTR.
0=Ignore DTR (default)
2=Dump incoming call when DTR is off
4=Hang-up incoming call when DTR is off
8=Hang-up outgoing call when DTR is off
- S35 ...DTE CONN.....Determines which is the current operating DTE connector.
0=V.35 connector (default)
1=RS-530 connector
- S40 ...BOND TXINIT.....Specifies the number of seconds the originating end point attempts to detect the BONDING negotiation pattern from the answering end point before deciding the BONDING call has failed. 0 to 256, **10 sec is default.**
- S41 ...BOND TXFA.....Specifies the number of seconds both end points attempt to detect the BONDING frame pattern when a call is connected before deciding the BONDING call has failed. When operating with other manufacturer's BONDING equipment it may be necessary to lengthen this timer so that it matches TXADD01. 0 to 256, **10 sec is default.**
- S42 ...BOND TXADD01.....The number of seconds both end points wait for the additional call to be connected at the end of negotiation before deciding the BONDING call has failed. When dialing overseas, it may be necessary to lengthen this timer to allow for lower call routing. 0 to 256, **50 sec is default.**
- S43 ...BOND TXDEQ.....The number of seconds both end points attempt to equalize the network delay between the bearer channels before deciding the BONDING call has failed. 0 to 256, **5 sec is default.**
- S44 ...BOND TANULL.....The number of seconds the answering end point attempts to detect the BONDING negotiation pattern from the originating end point before aborting to clear channel mode. It may be necessary to shorten this timer if the DTE equipment connected to the ISU 512 also has timer constraints for completing non-BONDING parameter negotiation. 0 to 256, **10 sec is default.**

-
- S45 BOND TCID. The number of seconds both end points attempt to negotiate agreeable values for bearer channels and channel capacities before deciding the BONDING call has failed. 0 to 256, **5 sec is default**.
- S47 RS 366 TIME Determines the amount of time the RS-366 port waits for either EON or inactivity to terminate a dial string before dialing a number.
0=Wait for EON only
10=Wait for 1 second or EON
20=Wait for 2 seconds or EON
50=Wait for 5 seconds or EON (default)
100=Wait for 10 seconds or EON
200=Wait for 20 seconds or EON
- S50 LINE MODE. Selects the operating mode of the ISU 512.
0=Dial service (switched service) (default)
1=Leased service (non-switched service)
- S51 LINE CLOCK. Selects the clock mode in leased mode.
0=Slave (default)
1=Master (leased line only, limited distance modem application only)
- S52 SWITCH TYPE Selects the network switch type for dial service.
0=AT&T 5ESS (default)
1=Northern Telecom DMS-100
2=National ISDN-1
3=NEC
4=EuroISDN (only available on the ISU 512 ST)
- S53 CALL TYPE. Call type.
0=Speech
1=Audio
2=56 kbps data
3=64 kbps data (default)

Appendix B. S-Register List

- S55DIAL MODE.Selects dialing interface.
0=Front panel only (dialing from front panel is always available) (default)
1=RS-366 dialing port
3=V.25 bis dialing
- S58CALL SCREENINGAllows the ISU 512 to screen incoming calls.
0=Answer any call (default)
1=Answer only calls from numbers matching those stored in SN0 through SN9
- S88RS-530 to V.35 Adapter Cable
0=Disable (default)
1=Enable
- S89RS-366 Y Cable Adapter
0=Disable (default)
1=Enable
- SS60 . . .Location SPID1
SS61 . . .Location SPID2
SS62 . . .Location SPID3
SS63 . . .Location SPID4
SS64 . . .Location SPID5
SS65 . . .Location SPID6
SS66 . . .Location SPID7
SS67 . . .Location SPID8
SS68 . . .Location LDN1
SS69 . . .Location LDN2
SS70 . . .Location LDN3
SS71 . . .Location LDN4
SS72 . . .Location LDN5
SS73 . . .Location LDN6
SS74 . . .Location LDN7
SS75 . . .Location LDN8

The following are the string locations for stored numbers 0 - 9:

- SS90 . . . SN0 LOC Stored number 0 string
- SS91 . . . SN1 LOC Stored number 1 string
- SS92 . . . SN2 LOC Stored number 2 string
- SS93 . . . SN3 LOC Stored number 3 string
- SS94 . . . SN4 LOC Stored number 4 string
- SS95 . . . SN5 LOC Stored number 5 string
- SS96 . . . SN6 LOC Stored number 6 string
- SS97 . . . SN7 LOC Stored number 7 string
- SS98 . . . SN8 LOC Stored number 8 string
- SS99 . . . SN9 LOC Stored number 9 string

Appendix B. S-Register List

Appendix C

AT Commands

The AT commands (shown in Table C-A) can be used with the Maintenance interface available at 9600 bps (8, n, 1) through the **CHAIN IN** port on the back panel. See the section *The Maintenance Interface* in Chapter 3 for more information.



Commands should be entered without the AT prefix.

Table C-A
AT Commands

Command	Definition	Function
A	Answer	Places the ISU 512 into answer mode
D	Dial	Precedes the telephone access number [ATD551212]
H	Hangup	Disconnects the current call
I0	Identify unit	Displays model number
I1	-	Displays software version
S	S-Register	-
SS	S String register	-
&W	-	Saves current configuration to EEPROM
Carrier Detect (CD) Control Line options		
&C0	-	CD forced
&C1	-	CD normal
&C2	-	CD with local disconnect
&C3	-	CD off link down

Table C-A
AT Commands

Command	Definition	Function
Data Terminal Ready (DTR) Control Line Options		
&D0	-	DTR ignored
&D1	-	DTR Off forces command
&D2	-	DTR Off forces idle (on allows auto answer)
Generic Unit Configurations		
&F0	-	Reset all S-registers
&F1	-	Dial 512K
&F2	-	Dial 384K
&F3	-	Dial 448K
&F4	-	Dial 336K
&F5	-	Video 384K
&F6	-	Video 336K
&F7	-	Leased Slave (not available on the ISU 512 ST)
&F8	-	Leased Master (not available on the ISU 512 ST)
&F9	-	Leased Slave Master (not available on the ISU 512 ST)
Network Options		
&L0	-	Dial Network
&L1	-	Leased Network (not available on the ISU 512 ST)
Data Set Ready (DSR) Control Line Options		
&S0	-	DSR forced
&S1	-	DSR if call up
&S2	-	DSR if link up
Accessing Stored Numbers for Dialing Options		
&Z0	-	Stored number 0
&Z1	-	Stored number 1
&Z2	-	Stored number 2
&Z3	-	Stored number 3

Table C-A
AT Commands

Command	Definition	Function
&Z4	-	Stored number 4
&Z5	-	Stored number 5
&Z6	-	Stored number 6
&Z7	-	Stored number 7
&Z8	-	Stored number 8
&Z9	-	Stored number 9
ISDN Switch Type Options		
_S0	-	5ESS
_S1	-	DMS-100
_S2	-	National ISDN-1
_S3	-	NEC
_S4	-	EuroISDN (only available on the ISU 512 ST)
ISDN U-interface Operational Mode Options		
_X0	-	ISU timing slaves to network (NT)
_X1	-	IU is U-interface timing master (LT)
Reset		
_Z	-	Unit reset, equivalent to cycling power
_F	-	Factory reset, equivalent to pressing 0 on power up

Appendix C. AT Commands

Appendix D Pinouts

Figure D-1 illustrates the EIA-232 to DB-25 adapter connector. Figures D-2 through D-4 show the interfaces for the pinouts identified in Tables D-A through D-F.

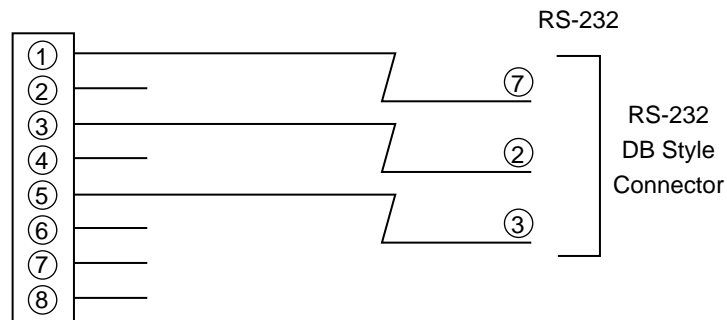

Figure D-1
EIA-232 to DB-25 Adapter Connector

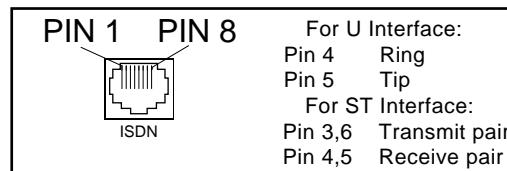

Figure D-2
RJ-45 ISDN Line Interface

Table D-A
Pinouts for Chain In and Chain Out Ports

Chain In Port		Chain Out Port	
Pin 1	Ground	Pin 1	Ground
Pin 3	Rx Data	Pin 3	Chain Rx Data
Pin 5	Tx Data	Pin 5	Chain Tx Data

Table D-B
Pinouts for IFC RJ-45 Connectors

IFC RJ-45 Connector	
Pin 4	Ring
Pin 5	Tip

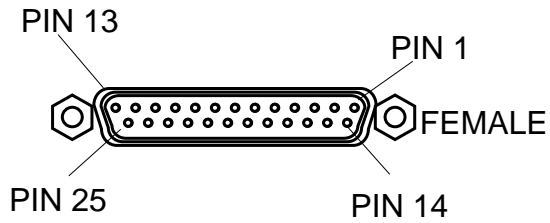

Figure D-3
EIA-232, RS-366, and RS-530 Connector

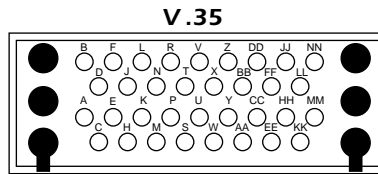

Figure D-4
V.35 Connector

Table D-C
RS-366 Dialing Port Pinouts

Pin	Name	Input/Output	Descriptions
1	Shield	I/O	Shield for Cable
2	DPR	I	Digit Present
3	ACR	O	Abandon Call and Retry
4	CRQ	I	Call Request
5	PND	O	Present Next Digit
6	PWI	O	Power Indication
7	SG	I/O	Signal Ground
13	DSC	O	Distant Station Connect
14	NB1	I	Digit LSB
15	NB2	I	Digit bit 2
16	NB4	I	Digit bit 3
17	NB8	I	Digit MSB
22	DLO	O	Data Line Occupied
Signals for 2nd RS-366 Port on RS-366 Y Cable			
8	BDPR	I	Digit Present
9	BACR	O	Abandon Call
10	BCRQ	I	Call Request
11	BPNDD	O	Present Next Digit
12	NC	N/A	No Connection
18	BDSC	O	Distant Station Carrier
19	BNB1	I	Digit LSB
20	BNB2	I	Digit Bit 2
21	BNB4	I	Digit Bit 3
23	NC	N/A	No Connection
24	BNB8	I	Digit MSB
25	BDL0	O	Data Line Occupied
I = Input, O = Output, N/A = Not Applicable			

See Figure D-3.

Table D-D
RS-530 Pinouts

Pin	Name	Input/Output	Descriptions
1	Shield	I/O	Shield for Cable
2	TD-A	I	Transmitted Data
3	RD-A	O	Received Data
4	RTS-A	I	Ready To Send
5	CTS-A	O	Clear To Send
6	DSR-A	O	Data Set Ready
7	SG	I/O	Signal Ground
8	CD-A	O	Carrier Detect
9	RC-B	O	Receive Clock (return)
10	CD-B	O	Carrier Detect (return)
11	ETC-B	I	External Transmit Clock (return)
12	TC-B	O	Transmit Clock (return)
13	CTS-B	O	Clear To Send (return)
14	TD-B	I	Transmit Data (return)
15	TC-A	O	Transmit Clock
16	RD-B	O	Receive Data (return)
17	RC-A	O	Receive Clock
18	NC	N/A	No Connection
19	RTS-B	I	Ready To Send (return)
20	DTR-A	I	Data Terminal Ready
21	NC	N/A	No Connection
22	DSR-B	O	Data Set Ready (return)
23	DTR-B	I	Data Terminal Ready (return)
24	ETC-A	I	External Transmit Clock
25	CABLE PWR	O	Power for RS-530 to V.35 Cable Adapter
I= Input, O = Output, N/A = Not Applicable			

See Figure D-3.

Table D-E
V.35 Pinouts

Pin	Name	Input/Output	Descriptions
A	Shield	I/O	Shield for Cable
B	SG	I/O	Signal Ground
C	RTS	I	Ready To Send
D	CTS	O	Clear To Send
E	DSR	O	Data Set Ready
F	CD	O	Carrier Detect
H	DTR	I	Data Terminal Ready
J	RI	O	Ring Indicator
P	SD-A	I	Send Data
R	RD-A	O	Receive Data
S	SD-B	I	Send Data (return)
T	RD-B	O	Receive Data (return)
U	TC-A	I	External Transmit Clock
V	RC-A	O	Receive Clock
W	TC-B	I	External Transmit Clock (return)
X	RC-B	O	Receive Data (return)
Y	ST-A	O	Send Timing
AA	ST-B	O	Send Timing (return)
K,L	NC	N/A	No Connection
M,N	NC	N/A	No Connection
BB	NC	N/A	No Connection
CC	NC	N/A	No Connection
DD	NC	N/A	No Connection
EE	NC	N/A	No Connection
FF	NC	N/A	No Connection
HH	NC	N/A	No Connection
J J	NC	N/A	No Connection
KK	NC	N/A	No Connection
LL	NC	N/A	No Connection
MM	NC	N/A	No Connection
NN	NC	N/A	No Connection
I = Input, O = Output, N/A = Not Applicable			

See Figure D-4.

Table D-F*RS-530-to-V.35 Adapter Cable Pinouts*

Pin	Name	Input/Output	Descriptions
A	Shield	I/O	Shield for cable
B	SG	I/O	Signal Ground
C	RTS	I	Ready to Send
D	CTS	O	Clear to Send
E	DSR	O	Data Set Ready
F	CD	O	Carrier Detect
H	DTR	I	Data Terminal Ready
J *	RI	O	Ring Indicator
P	SD-A	I	Send Data
R	RD-A	O	Receive Data
S	SD-B	I	Send Data (return)
T	RD-B	O	Receive Data (return)
U	TC-A	I	External Transmit Clock
V	RC-A	O	Receive Clock
W	TC-B	I	External Transmit Clock
X	RC-B	O	Receive Clock (return)
Y	ST-A	O	Send Timing
AA	ST-B	O	Send Timing (return)
BB	NC	N/A	No Connection
CC	NC	N/A	No Connection
DD	NC	N/A	No Connection
EE	NC	N/A	No Connection
FF	NC	N/A	No Connection
HH	NC	N/A	No Connection
JJ	NC	N/A	No Connection
KK	NC	N/A	No Connection
LL	NC	N/A	No Connection
MM	NC	N/A	No Connection
NN	NC	N/A	No Connection

*Pin J (ring indicator) is needed for most video conferencing applications.

See Figure D-4.

Figure D-5 displays the RS-366 Y cable, part number 1200120L1.

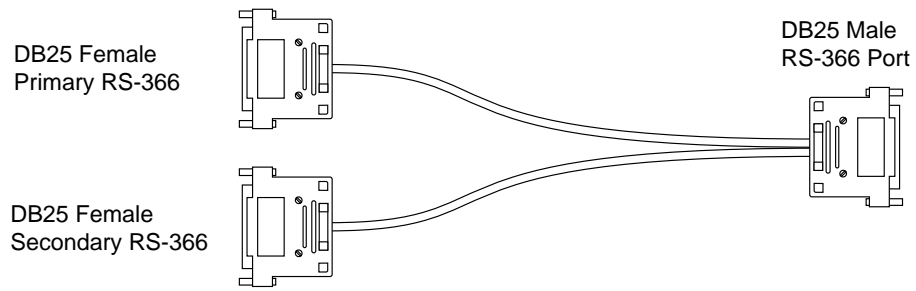

Figure D-5
RS-366 Y Cable

Figure D-6 displays the RS-530 to V.35 adapter cable, part number 1200072L1.

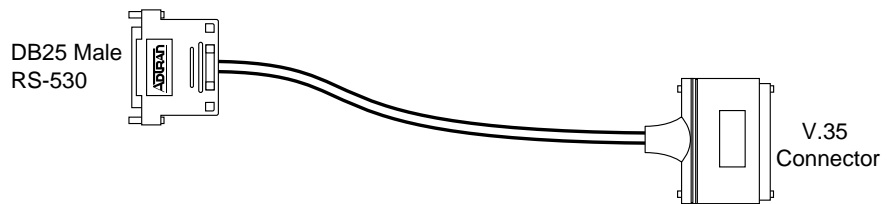

Figure D-6
RS-530 to V.35 Adapter Cable

Appendix D. Pinouts

Acronyms

AMI	Alternate Mark Inversion
ANI	Automatic Number Identification
BONDING	Bandwidth On Demand Interoperability Group
BRI	Basic Rate Interface
CCITT	Consultative Committee for International Telegraphy and Telephony
CD	Carrier Detect
CO	Central Office
CIC	Carrier Identification Code
CTS	Clear to Send
D-Delta	Signalling Channel
DCE	Data Communications Equipment
DMS	Digital Multiplex Switching
DN	Directory Number
DSR	Data Set Ready
DTE	Data Terminal Equipment
EIA	Electronic Industries Association
EKTS	Electronic Key Telephone Service
ESS	Electronic Switching System
FAX	Facsimile
FEBE	Far End Block Errors
FX	Foreign Exchange
ID	Identification
I/O	Input/Output
IOC	ISDN Ordering Codes
ISDN	Integrated Services Digital Network
ISU	ISDN Service Unit
kbps	kilobits per second

Acronyms

LAN	Local Area Network
LDM	Limlited Distance Modem
LDN	Local Directory Number
LED	Light Emitting Diode
MLHG	Multiline Hunt Group
NEBE	Near-End Block Errors
NI-1	National ISDN-1
NT	Network Termination
PC	Personal Computer
POTS	Plain Old Telephone Service
SPID	Service Profile Identifier
TA	Terminal Adapter
TE	Terminal Equipment
TEI	Terminal Endpoint Identifier
WAN	Wide Area Network

Glossary

2 B+D

The basic rate interface (BRI) in ISDN. A single ISDN circuit divided into two 64 kbps digital channels for voice or data and one 16 kbps channel for low speed data (up to 9,600 baud) and signaling. 2B+D is carried on one or two pairs of wires depending on the interface, the same wire pairs that today bring a single voice circuit into your home or office. See *ISDN*.

2B1Q

Two binary, one quarternary. An ISDN line encoding technique which uses two bits to represent four variations in amplitude and polarity.

asynchronous transmission

Not synchronous. A method of data transmission which allows characters to be sent at irregular intervals by preceding each character with a start bit and following it with a stop bit. The timing of the transmission is not determined by the timing of a previous character. Applications include communication between most small computers (especially PCs) and mainframes, lower speed transmission, and less expensive computer transmission systems. See *synchronous*.

B channel

64 kbps bearer channel used for voice, circuit, or packet switched data.

bearer service

As defined by CCITT standards, a type of telecommunication service that provides the capability for the transmission of information between user-to-network interfaces. Bearer services defined for ISDN are circuit mode and packet mode.

BONDING protocol

Industry standard B channel aggregation protocol. Developed by the Bandwidth on Demand Interoperability Group.

bridging

The technique whereby additional stations may be served from a two-point facility by extending the facility from a bridge at one of the facility's terminating points.

CCITT

Consultative Committee on International Telephony and Telegraphy. A body of the International Telegraph Union (ITU) which prepares recommendations, commonly referred to as international standards, to resolve technical telegraph and telephone problems.

central office (CO)

In telephony, the phone company switching facility or center, usually a Class 5 end office, at which subscriber's local loops terminate. Handles a specific geographic area, identified by the first three digits of the local telephone number. Usually the facilities of the local BOC.

channel bank

Equipment in a telephone central office that performs multiplexing of lower speed digital channels into a higher speed composite channel. The channel bank also detects and transmits signaling information for each channel, transmitting framing information so that time slots allocated to each channel can be identified by the receiver.

clear channel

A channel in which all the 64 kbps are used for transmission. To achieve this bit robbing signaling must be eliminated.

CPE

Customer premises equipment. A generic term for communications terminal gear owned by the customer, residing on customer premises.

CSU

Channel service unit. A component of CPE used to terminate a digital circuit, such as DDS or T1 at the customer site. Performs certain line-conditioning functions, ensures network compliance per FCC rules, and responds to loopback commands from the central office. Also ensures proper 1s density in transmitted bit stream and performs bipolar violation correction. See *DSU*.

D-channel

The ISDN channel that carries signaling information to control the call setup, tear-down, or invocation of supplementary services. The D-Channel may also be used to provide Packet Mode Data Service.

DCE

Data communications equipment. The portion of a data terminal that provides the interface to the network.

DDS

Dataphone digital service. AT&T private line service for transmitting data over a digital system. The digital transmission system transmits electrical signals directly, instead of translating the signals into tone of varied frequencies as with traditional analog transmission systems. Digital techniques provide more efficient use of transmission facilities, resulting in lower error rates and costs than analog systems.

digital loopback

Technique for testing the digital processing circuitry of a communications device. May be initiated locally or remotely via a telecommunications circuit. Device being tested will echo back a received test message after first decoding and then encoding it. The results are compared with the original message (compare with analog loopback).

DSU

Data service unit. A device providing an interface between a data terminal or other data communications device and a digital access line.

DTE

Data terminal equipment. The portion of a data terminal that interfaces to the end-user's equipment. The main difference between DCE and DTE is that pins 2 and 3 are reversed on the RS-232.

frame

A group of bits sent serially over a communications channel. Generally a local transmission unit sent between data-link-layer entities that contains its own control information for addressing and error checking. The basic data transmission unit is employed with bit-oriented protocols, similar to blocks. In video transmission, a set of electron scan lines that comprise a television picture (usually 525 in the U.S.).

four-wire circuits

Telephone lines using two wires for transmitting and two wires for receiving offering much higher quality than a 2-wire circuit. All long distance circuits are 4-wire. Almost all local phone lines and analog phones are 2-wire.

in-band signaling

Signaling made up of tones which pass within the voice frequency band and are carried along the same circuit as the talk path being established by the signals. Virtually all signaling (request for service, dialing, disconnect, etc.) in the U.S. is in-band signaling. Most of that signaling is MF (multi-frequency) dialing. The more modern form of signaling is out-of-band.

information element

The name for the data fields within an ISDN Layer 3 message.

interface

A common boundary between two systems over which the inter-system communication occurs.

ISDN

Integrated services digital network. A network architecture that enables end-to-end digital connections. The network supports diverse services through integrated access arrangements and defines a limited set of standard, multipurpose interfaces for equipment vendors, network providers, and customers. Interworking with a public switched telephone network is retained.

leased line

A telecommunication facility or link reserved for the exclusive use of one customer. Also called a dedicated line.

leased service

The exclusive use of any channel or combination of channels designated to a subscriber.

local loop

In telephony the wire pair that connects a subscriber to a phone company end office, typically containing two wires. Four-wire local loops are common, however, especially with leased voice grade circuits.

loopback

A diagnostic procedure where data is sent to the device being tested, and the output of the device is fed directly back to its input, looped around, and the returning data is checked against that which was sent.

loopback test

A test typically run on a 4-wire circuit. Two transmit leads are joined to the two receive leads. A signal is then sent around the loop. Measuring differences between the sent and received signal is the essence of a loopback test.

master clock

The source of timing signals, or the signals themselves, which all network stations use for synchronization.

message

The Layer 3 information that is passed between the CPE and SPCS for signaling.

multiplexing

The combining of multiple data channels onto a single transmission medium. Any process through which a circuit normally dedicated to a single user can be shared

by multiple users. Typically, user data streams are interleaved on a bit or byte basis (time division) or separated by different carrier frequencies (frequency division).

multipoint circuit

A circuit consisting of three or more stations connected directly electrically.

non-ISDN line

Any connection from a CPE to a SPCS that is not served by D-Channel signaling.

non-ISDN trunk

Any trunk not served by either SS7 or D-Channel signaling.

NT1

Network termination 1. A unit that provides physical and electromagnetic termination of the U-interface 2-wire transmission line, converts between Layer 1 formats used at the U- and T- reference points, and performs some maintenance functions.

packet mode

Refers to switching of packets of information for different users by statistically multiplexing them over the same transmission facilities. ISDN packet mode capabilities are based on CCITT recommendation X.25 procedures.

point-to-point

Describing a circuit connecting two points directly with no intermediate processing nodes or computers (although switching facilities could exist). A type of connection that links two logical entities (i.e., phone-line circuit).

EIA-232-C

An EIA-specified physical interface with associated electrical signaling between DCE and DTE. The most commonly employed interface between computer devices and modems.

RS-366

An EIA interface standard for autodialing.

RS-530

Interface using a DB-25 connector, but for higher speeds than RS-232. Has balanced signals (like EIA-422) except for three maintenance signals which are EIA-423.

SDLC

Synchronous data link control. A data communications line protocol associated with the IBM system network architecture. SDLC is a bit-oriented protocol (not a character-oriented protocol) that includes multiple block error checking and full duplex line operation.

S interface S reference point

The interface that connects an ISDN terminal (TEI) or terminal adapter (TA) to the NT2 reference point as defined in the I.411 Recommendation.

synchronous

1. The condition occurring when two events happen in a specific time relationship with each other, both under control of a master clock. 2. A method of data transmission requiring the transmission of timing pulses to keep the sender and receiver synchronized in their communication used to send blocks of information. Synchronous data transmission is used in high speed data circuits because there is less overhead than asynchronous transmission of characters which contain two extra bits per character to affect timing.

T interface T reference point

Performs the same function as the S interface but uses an NT1 rather than an NT2.

T1

Also T-1. A digital transmission link with a capacity of 1.544 Mbps. T1 uses two pairs of normal twisted wires. T1 normally can handle 24 voice conversations with each conversation being digitized at 64 kbps. With more advanced digital voice encoding techniques, it can handle more voice channels. T1 is a standard for digital transmission in North America.

TA

Terminal adaptor. A DCE that connects to the ISDN S-Interface and enables non-ISDN terminal equipment to communicate over the ISDN.

trunk

A single transmission path connecting two switching system. Trunks can be shared by many users, but serve only one call at a time.

two-wire circuit

A transmission circuit composed of two wires, signal and ground, used to both send and receive information. In contrast, a 4-wire circuit consists of two pairs. One pair is used to send. One pair is used to receive. All trunk circuits (long distance) are 4-wire. A 4-wire circuit delivers better reception, but also costs more. All local loop circuits (those coming from a Class 5 central office to the subscriber's phone system) are 2-wire, unless a 4-wire circuit is requested.

U-Interface

A twisted pair subscriber loop that connects the NT1 reference point to the ISDN network, as defined in the I.411 Recommendation. This interface provides Basic Rate Access with an operating frequency of 160 kbps and an information rate of 144 kbps. Under U.S. regulations, this also marks the line of demarcation between customer-owned equipment and the public network.

V.35

CCITT standard for trunk interface between a network access device and a packet network that defines signaling for data rates greater than 19.2 kbps.

videoconferencing

The real-time, usually two-way, transmission of digitized video images between two or more locations. Teleconferencing requires a wideband transmission facility. Transmitted images may be freeze-frame (where television screen is repainted every few seconds to every 20 seconds) or full motion. Bandwidth requirements for two-way videoconferencing range from 6 MHz for analog, full-motion, full-color, commercial grade TV to 56 kbps for digitally-encoded freeze-frame to 1.544 kbps for very good quality, full-color, full-motion TV.

XMODEM

An error-correcting file transfer, data transmission protocol used to transmit files between PCs. The XMODEM protocol sends information in 128 byte blocks of data. Some sums (check sums) are done on each block and the result is sent along with the block. If the result does not check out at the other end, the computer at the other end sends a request (a NAK - negative acknowledgment) to retransmit that block once again. If the block checks out, the computer sends ACK (an acknowledgment). In this way, relatively error-free transmission can be accomplished.

Glossary

Numerics

- 1 sec or EON 31
- 10 sec or EON 32
- 2 sec or EON 31
- 2 x clear channel protocol 5, 49
- 20 sec or EON 32
- 2047 checker 58
- 5 sec or EON 32

A

- adapter
 - EIA-232 to DB-25 89
- ADLP address 37, 41
- answer call 54
- arrow keys 20, 23
- AT commands 85
- audio 28
- auto answer 33
 - menu path to configure 33
- auto traps 37, 41

B

- B channel aggregation 68
- bit error rate test (BERT) 57
- bit rate 22
- BONDING mode 1 2, 5, 68
- BONDING mode 1 protocol 46, 49
- BONDING protocol 58
- bonding setup 22, 46

C

- cable
 - RS-366 Y 95
 - RS-530 to V.35 95
- call ID 34
- call NumID 38
- call screening 34
- call stagger 48
- call type 10, 11, 22, 27
 - audio 28
 - data 56 kbps 28
 - data 64 kbps 28
 - default 28
 - menu path to configure 27
 - speech 28
- cancel 20, 21, 23
- capability R 7
- capability S 7
- carrier detect 23
- CD options 44
 - menu path for setting 44
- chain in port 12, 13, 14
 - pinout 89
- chain out port pinout 89
- channel rate 10, 11, 40
- CIC/DIC 33
- clear to send 23
- clock mode 39
 - master timing 39
- configuration 21, 25
 - menu 21, 26
 - quick setup 50

connect timeout 34
connector
 EIA-232 90
 RS-366 90
 RS-530 90
 V.35 90
connector type
 selecting 43
CTS options 44
 menu path for setting 44
customer service 9

D

D channel switch compatibility 68
damage 9
data 56 kbps 28
data 64 kbps 28
data rates 67
data set ready 23
dial 21
dial 336K 51
dial 384K 51
dial 448K 51
dial 512K 50
dial interface connection 10
dial line 27
dial menu 21
dial number 54
dial operation 9
 configuring network options for 27
dial options 30
 menu 31
dial stored number 54
dialing
 examples 11
 from the ISU 512 3
dialing options 54
 answer call 54
 dial number 54
 dial stored number 54

hang up line 54
 menu path for setting 54
 redial last number 54
 store/review number 55
dialing selections 67
display specifications 68
down arrow 21, 23
DSR options 45
 menu path for setting 45
DTE 1, 10, 21
 data connection 10
DTE interface 67
DTE options
 quick setup 50
 selecting maximum bit rate 42
 setting 42
DTR options 44
 menu path for setting 45

E

EIA-232 to DB-25 adapter connector 89
enter 21, 23
environmental specifications 68
EON 31
EuroISDN switch type 61

F

far-end block errors 59
flash memory 13
 downloading 35
front panel 22, 31
function keys 21

G

generic data I 7
generic data M 7

H

hang up line 33, 54

I

if an ISDN network line reads down 61

if self test fails 61

if the display reads

 SPID{1,3,5, or 7} 65

 SPID{2,4,6, or 8} 65

 TEI1 63

 TEI2 64

IFC RJ-45 connectors 9

information desk

 ISDN 8

initial self test 19

installation 9

interoperability 4, 67

ISDN

 basic rate switched service 25

 information desk 8

 network line down 61

 ordering 7, 8

 ordering codes 7

 overview 1

ISU 512

 applications 4

 dialing from 3

 features 67

 interoperability 4

 product overview 1

 rear panel 2

 specifications 67

 synchronous rates 5

L

LCD display 22

LCD window 23

LDN

 setting 30

leased application with channel banks
 40

leased digital service

 configuring the ISU 512 for 39

leased line 39

 menu 39

leased master 39, 52

leased operation 9

leased slave 39

leased slave and Ldm SlvMstr 53

LED description 23

limited distance modem application 40

loopback

 DTE 57

 points 57

 protocol 57

M

main menu 20

maintenance interface 12

maintenance port commands 12

maintenance port VT-100 menu 12

maintenance setup

 ADLP address 37

 auto traps 37

 dial operation 37

 leased operation 41

 options 37

 port mode 37

maximum bit rate 42

menu structure 20

menu traversal 21

N

near-end block errors 59

NEBE/FEBE 59

network

 connection 9

 connection status 19

- interface 67
 - options 22, 27
- numeric keypad 23

O

- operating protocols 5
- operation 19
- ordering codes
 - ISDN 7
- ordering ISDN 8

P

- physical dimensions 68
- pinouts 89
 - chain in and chain out ports 89
 - IFC RJ-45 connector 90
 - RS-366 dialing port 91
 - RS-530 92
 - RS-530 to V.35 adapter cable 94
 - V.35 93
- port mode 37, 41
- power 68
- problem
 - procedure for isolating 62
- product overview
 - ISU 512 1
- protocol
 - 2 x clear channel 5, 49
 - BONDING 58
 - BONDING mode 1 46, 49, 68
 - clear channel 5
 - recommended operating 5
 - XMODEM 13

Q

- quick setup configuration 50

R

- radio frequency interference
 - prevention 10
- rate adaption 67
- rear panel 2
- receive data 23
- redial last number 54
- remote access 35
- remote download (RDL) 35
 - password 35
- remote supervision 36
 - password 36
- request to send 23
- RJ-45 9
- RJ-45 connector 2, 90
- RJ-45 ISDN line interface 89
- RS-366 31
 - converting to two ports 49
 - dialing 31
 - out of band 10
 - security 32
- RS-366 dialing port interface 10
 - pinouts 91
- RS-366 Y cable 43, 95
 - adapter 49
- RS-530 interface 10
- RS-530 pinouts 92
- RS-530 to V.35 adapter cable 95
 - pinouts 94
- RS-530 to V.35 cable 43

S

- security 32
- self test 19
- self test failure 61

-
- setting auto answer
 - disabled 33
 - dump all calls 33
 - enabled 33
 - setting CD options 44
 - setting CTS options 44
 - setting DSR options 45
 - setting DTE options 42
 - setting DTR options 44
 - setting terminal identification 29
 - setting the call type 27
 - setting the dial options
 - front panel 31
 - V.25 bis 32
 - setting the LDN 30
 - setting the SPID 29
 - setting the terminal identification
 - setting the LDN 30
 - setting the SPID 29
 - smart dial string 13, 35, 36, 58
 - formats 10
 - software
 - update 13
 - software version 59
 - specifications
 - environmental 68
 - physical 68
 - summary 67
 - speech 28
 - SPID
 - obtaining 29
 - setting 29
 - SPID1 65
 - SPID2 65
 - S-register list 79
 - S-registers 12
 - status 20
 - status buffer messages 20, 69
 - status menu 20
 - store/review number 55
 - switch type 27
 - menu path to configure 27
- ## T
- TANULL 47
 - TCID 48
 - TEI1 63
 - TEI2 64
 - temperature
 - operating 68
 - storage 68
 - terminal identification 29
 - menu path to set 29
 - terminal ready 23
 - test 20
 - test menu 20
 - test options 57
 - 2047 checker 58
 - loopback DTE 57
 - loopback protocol 57
 - menu path to select 57
 - NEBE/FEBE 59
 - software version 59
 - test remote 41
 - transmit data 23
 - transparent 2 x clear channel protocol 49
 - troubleshooting 61
 - two channel calls
 - non-bonded 11
 - TXADD01 47
 - TXDEQ 47
 - TXFA 47
 - TXINIT 46

U

- up arrow 20, 21, 23
- updating ISU 512 software
 - local method 13
 - remote method 13
- using ISDN Basic Rate switched service 25

V

- V.25
 - DCE/DTE control signals 56
- V.25 bis 32
 - commands to control automatic calling and answering 56
 - in-band dialing 56
- V.35
 - connector 90
 - pinouts 93
- V-35
 - interface 10
- video 336K 52
- video 384K 52
- video conferencing equipment setting 50
- VT-100 2, 12
 - configuration menu 15
 - dial menu 17
 - maintenance port menu 12
 - menu interface 14
 - status screen 16
 - Test Menu 16

W

- wait for EON 32

X

- XMODEM protocol 13

Product Support Information

Presales Inquiries and Applications Support

Please contact your local distributor, ADTRAN Applications Engineering, or ADTRAN Sales:

Applications Engineering	(800) 615-1176
Sales	(800) 827-0807

Post-Sale Support

Please contact your local distributor first. If your local distributor cannot help, please contact ADTRAN Technical Support and have the unit serial number available.

Technical Support	(888) 4ADTRAN
-------------------	---------------

Repair and Return

If ADTRAN Technical Support determines that a repair is needed, Technical Support will coordinate with the Return Material Authorization (RMA) department to issue an RMA number. For information regarding equipment currently in house or possible fees associated with repair, contact RMA directly at the following number:

RMA Department	(205) 963-8722
----------------	----------------

Identify the RMA number clearly on the package (below address), and return to the following address:

ADTRAN, Inc.
RMA Department
901 Explorer Boulevard
Huntsville, Alabama 35806

RMA # _____