

ADURAN

TSU 600

USER MANUAL

**Part Number 1200076L2
1200076L2#DC**

61200.076L2-1B
July 1997

Trademarks:

Windows is a registered trademark of Microsoft Corporation.



901 Explorer Boulevard
P.O. Box 140000
Huntsville, AL 35814-4000
Phone: (205) 963-8000

© 1997 ADTRAN, Inc.
All rights reserved.
Printed in USA.

FCC regulations require that the following information be provided to the customer in this manual.

1. This equipment complies with Part 68 of the FCC rules. The required label is affixed to the bottom of the chassis.
2. If your telephone equipment TSU 600 causes harm to the telephone network, the Telephone Company may discontinue your service temporarily. If possible, they will notify you in advance. But if advance notice isn't practical, you will be notified as soon as possible. You will be advised of your right to file a complaint with the FCC.
3. Your telephone company may make changes in its facilities, equipment, operations, or procedures that could affect the proper operation of your equipment. If they do, you will be given advance notice so as to give you an opportunity to maintain uninterrupted service.
4. If you experience trouble with this equipment TSU 600, please contact ADTRAN Customer Service for repair/ warranty information (see the inside back cover of this manual). The telephone company may ask you to disconnect this equipment from the network until the problem has been corrected, or until you are sure the equipment is not malfunctioning.
5. This unit contains no user serviceable parts.
6. The following information may be required when applying to your local telephone company for leased line facilities.

Service Type	Digital Facility Interface Code	Service Order Code	Network Jacks
1.544 Mbps Digital Interface SF	04DU9-B	6.0F	RJ48C
1.544 Mbps Digital Interface ESF	04DU9-C	6.0F	RJ48C
1.544 Mbps Digital Interface ESF with B8ZS	04DU9-S	6.0F	RJ48C

**FEDERAL COMMUNICATIONS COMMISSION
RADIO FREQUENCY INTERFERENCE STATEMENT:**

This equipment has been tested and found to comply with the limits for a Class A digital device, pursuant to Part 15 of the FCC Rules. These limits are designed to provide reasonable protection against harmful interference when the equipment is operated in a commercial environment. This equipment generates, uses, and can radiate radio frequency energy and, if not installed and used in accordance with the instruction manual, may cause harmful interference to radio frequencies. Operation of this equipment in a residential area is likely to cause harmful interference in which case the user will be required to correct the interference at his own expense.

Shielded cables must be used with this unit to ensure compliance with Class A FCC limits.

WARNING: Change or modifications to this unit not expressly approved by the party responsible for compliance could void the user's authority to operate the equipment.

Table of Contents

Chapter 1. Introduction

T1/FT1 Overview	1
T1 Service Offerings	1
Fractional T1	2
TSU 600 Overview	3
Functional Description	3
TSU	3
TSU 100	3
TSU 600	3
Identification of Rear Panel Layout	5
Features of the TSU 600	6
TSU Interfaces	7
Network Interface	7
Control Port Input	8
Chain Port Output	8
Three Methods of Control	9
Front Panel	9
ADTRAN PC Program	9
SNMP	9
Option Slot Arrangement	10
Slot 1	10
Slot 2	10
Slots 3-5	10
Slot 6	11
Option Ports	12
Secondary Interfaces (SI)	12
Other Data Interfaces	12
TSU 600 Clock Sources	13
Network Timed	13
DTE Timed	14
Internal Timing	15
Normal (CSU) Timing	16
TSU 600 Testing	17
Self Tests	17

- Loopback Tests 17
 - Classes of Loopbacks 18
 - Network Interface Loopbacks 18
 - DTE Interface Loopbacks 18
- Pattern Generation 20
 - QRSS Generation 20
 - 511 Pattern 20
- TSU 600 Configuration Applications 21
 - TSU 600 Option Modules 21
 - Bridge, PBX, Video Conferencing Application 21
 - All Voice Application 22
 - Drop and Insert, and Bridging Application 23
 - Variations of Mixed Applications 23
 - Regional Sales Office 23
 - Branch Office 23
 - Corporate 24
 - T-Watch Management Software 24

Chapter 2. Installation

- Unpack, Inspect, Power Connection 25
 - Shipped by ADTRAN 25
 - Provided by Customer 25
 - Power Connection 26
 - DC Powered Units 26
- Warranty and Customer Service 27
- Grounding Instructions (UL 1459) 28
- Wiring 30
 - Network 30
 - Connections 30
 - Control In/Chain-in 31
 - Connections 31
 - Chain-out 32
 - Connections 32
- Power Up Testing and Initialization 33
 - Self Test 33
 - Set User Passcode 34
 - To Establish a Passcode 34
 - Special Feature 34
 - No Passcode Desired 35
 - Set Unit Identification 35
 - To Set the Unit Identification 35

No Unit ID Desired	35
Set Control Port	36
Control-In (PC)	36
Chain-in	36
Normal Power-Up Procedure	38
Correct Passcode	38
Incorrect Passcode	38
No Passcode	38
Chapter 3. Operation	
Operation	39
Identification of Front Panel Layout	39
Display Panels	40
Remote	40
Module Status	40
LCD Window	41
CSU Status	41
Operation Keys	41
Copy	41
Remote	41
Home	41
Alarm	42
Shift	42
Clear	42
Cancel	42
Enter	42
Up and Down Arrows	42
Keypad	42
A, B, C, D, E, F	42
2	42
General Menu Operation	43
Select and Activate a Menu Item	43
Set the Data Field	44
Display Only Data Fields	45
Exit Any Menu Field Operation Or Display	45
Data Port Identification	45
Menu Structure	47
Opening Menu Functions	48
Status	48
Network Interface Performance Reports (NI PERF RPTS) ...	48
Network Interface (NI) Errors	48

Active Alarms	48
View History	49
Port Status	49
Remote Port	49
Configuration (CONFIG)	49
Network (NI)	49
Unit	49
Map Exchange (Map XCHANG)	49
Map In Use	49
DSO Map: A(B)	49
Port Configuration(Port Config)	49
Utility (UTIL)	50
Time/Date	50
Factory Restore	50
Set Passcode	50
Unit ID	50
Software Revision (Software REV)	50
Test	51
Network Tests	51
Run Self Test	51
Port Test	51
Cancel Tests	51
Opening Menu Functions: Detailed Discussion	51
Status	52
Network Performance Reports (NI PERF RPTS)	53
Network Interface Errors (NI ERRORS)	54
Active Alarms	55
View History	56
Port Status	56
Remote Port	57
Configuration (CONFIG)	58
Network (NI)	59
Operation	59
Network (NI) Menu Items	59
Unit	61
Operation	61
Unit Menu Items	61
Map Exchange (Map Xchng)	62
Operation	62
Map Exchange (Map Xchng) Menu items	62

Map In Use: A(B)	64
Operation	64
DS0 Map A and DS0 Map B	64
Operation	65
DS0 Map A and Map B Menu Items	65
Port Configuration (PORT CONFIG)	69
Operation	69
Utility (UTIL)	70
Time/Date	71
Operation	71
Summary for Editing Time/Date	71
Factory Restore	72
Operation	72
Set Passcode	73
Enter Passcode from Other Menus	73
Change/Set a Passcode	73
Unit ID: ID	74
Operation	74
Software Revision (Software Rev)	75
Operation	75
Port Utility	76
Operation	76
Test	77
Network Tests	78
Operation	78
Network Tests Menu Items	78
Local Loopback	78
Remote Loopback	79
Pattern	80
Pattern Result	80
Run Selftest	82
Operation	82
Port Tests	83
Operation	83
Cancel Tests	83
Chapter 4. Example Operations	
Voice and Data Mix	85
Steps to Set Up Voice and Data Mix	86
Prior to Step 1	86
Step 1. Configure the Network	86
Step 2. Configure DTE Port (1.1 - Nx56/64) (From Option Module)	87

Step 3. Select the number of DS0s/Port: 12 87

Step 4. Complete the DS0 Map Configuration 88

Step 5. Complete a Configuration Table for the DSX-1
 PBX Passthru 89

Step 6. Activate Configuration Menu 89

Configuring the Network Interface 90

Configuring the DS0 Map 92

Temporary Map 95

 Review 95

 Edit 96

 Configuring the Ports 98

Testing Example 100

 Far End Looped Back Test 100

 Network Interface Test 100

 Test Termination 105

Appendix A. TSU 600 Menu Tree 107

Appendix B. DTE Data Rate Chart 109

Appendix C. System Configuration Chart 111

 Step 1: Configure Network 111

 Step 2: Configure DTE PORT: (1.1Nx56/64) 111

 Step 3: Select number of DS0s/PORT _____ 112

 Step 4: DS0 Map A Configuration 113

 Step 5: DS0 Map B Configuration 113

Figures

Figure 1-1. Front View of the TSU 600 3

Figure 1-2. TSU 600 Rear Panel 5

Figure 1-3. TSU 600 Interfaces 7

Figure 1-4. TSU 600 Option Slot Arrangement 11

Figure 1-5. Network Timed Clock Source 13

Figure 1-6. DTE Clock Source 14

Figure 1-7. Internal Clock Source 15

Figure 1-8. Normal (CSU) 16

Figure 1-9. Network Loopback Tests 18

Figure 1-10. DTE Interface Loopback 19

Figure 1-11. Port Interface Loopback 19

Figure 1-12. TSU 600 Option Modules 21

Figure 1-13. Bridge, PBX, Video Conferencing Application Set Up 21

Figure 1-14. All Voice Application Set Up 22

Figure 1-15. Drop and Insert, Voice, and Bridging Application Set Up	23
Figure 1-16. Variations of Mixed Applications	24
Figure 2-1. Example of Chain-in	37
Figure 3-1. TSU 600 Front Panel Layout	40
Figure 3-2. Select a Menu Item	43
Figure 3-3. Sample Submenu	44
Figure 3-4. Display and Data Fields	45
Figure 3-5. Module Slots, TSU 600	46
Figure 3-6. The Four Opening Menus	47
Figure 3-7. Display of Opening Menus	48
Figure 3-8. Complete Status Menu	52
Figure 3-9. Network Interface Performance Report	53
Figure 3-10. Network Interface Error Type	55
Figure 3-11. Display of Alarm Messages	56
Figure 3-12. Complete Configuration Menu	58
Figure 3-13. Map Exchange Selection Display	62
Figure 3-14. Selection Times for Map Exchange	63
Figure 3-15. DSO Map Designations	64
Figure 3-16. Create Temp Selection Screen	66
Figure 3-17. Selected Port and Quantity of DSOs	67
Figure 3-18. Port Configuration	69
Figure 3-19. Complete Utility Menu Tree	70
Figure 3-20. Complete Test Menu	77
Figure 3-21. Test Pattern Results Display	81
Figure 4-1. Example of Voice and Data Mix	85
Figure 4-2. First Two Configuration Menu Items	89
Figure 4-3. First Two Network (NI) Configuration Menu Items	90
Figure 4-4. First Two Network (NI) Menu Items	91
Figure 4-5. DSO Map A and Map B Configuration Menu Items	92
Figure 4-6. Create Map Menu with Displayed DSO Number	92
Figure 4-7. Passthru Selection Field	93
Figure 4-8. Display of DSO Port Name	93
Figure 4-9. First Screen for Choosing to Review Temporary Files	95
Figure 4-10. A Review Screen	95
Figure 4-11. Window Showing Edit Temp Option	96
Figure 4-12. Window Showing the Error	97
Figure 4-13. Window Showing Port Configuration Option	98
Figure 4-14. Screen Used To Change Mode	98
Figure 4-15. Test Menu One	101
Figure 4-16. The Four Test Submenu Windows	102
Figure 4-17. Screen that Appears During Loopback Verification	103
Figure 4-18. Test Pattern Screen for QRSS all DSOs	103

Figure 4-19. Test Pattern Results Display 104
Figure A-1. TSU 600 Complete Menu Tree 108

Tables

Table 2-A. Network Pinout 30
Table 2-B. Control In/Chain-in Pinout 31
Table 2-C. Chain-out Pinout 32
Table B-A. DTE Data Rate vs. DS0s 110
Table C-A. Control Pin Connection Configuration Chart for
Network Interface 111
Table C-B. Configuration Chart for DTE Port 112
Table C-C. DS0 Map A Configuration 113
Table C-D. DS0 Map B Configuration 113

Chapter 1

Introduction

T1/FT1 OVERVIEW

The T1 digital communications link has been used by telephone companies (telcos) for transmitting voice since the early sixties. The D4 channel bank is a T1 digital carrier system that was introduced in the mid seventies and is still widely used by telcos. Communication demands of businesses continued to grow to the point that the telcos began offering T1 service directly to the public. D4 channel banks began to be used for T1 in corporate network topographies for voice. The technological advances in computer development also created a demand for T1 data communication which now is a large part of the T1 traffic.

T1 Service Offerings

T1 is a digital service that is delivered to the user over two pairs of wires from the service provider. The signal operates at 1.544 Mbps and is usually extended by repeaters that are installed about every mile after the first 6000 feet. The T1 signal is divided into 24 time slots which operate at 64 kbps (DSOs). Each time slot is occupied by digitized voice or by data.

The T1 signal originally used a type of framing known as D4 Superframe which identifies how the T1 is multiplexed. An enhancement of that framing format, called Extended Superframe Format (ESF), is available. It provides a non-disruptive means of full time monitoring on the digital facility. The ESF was originally used by the service provider to monitor the

performance of their service offering. Since the introduction of ESF, equipment that is installed in private networks can also provide the same performance information to the user.

Fractional T1

Fractional T1 (FT1) lets the buyer purchase less than a full T1 circuit between two points. Most carriers offer fractional T1 in increments of 56 or 64 kbps. Connection is made to the same network elements. The network allows multiple users to share the same interoffice T1 bandwidth.

Fractional T1 remains almost exclusively an Inter-Exchange Carrier (IXC) service. Local Exchange Carriers (LECs) typically do not offer FT1, so the proximity of the user to the point of presence (POP) of the IXC is key in the savings that fractional T1 offers.

Fractional T1 local access is available in two forms, 56 kbps or a full T1 line. In 56 kbps the required number of DDS lines is extended from the IXC POP and the bandwidth is combined at the office on an outbound T1 circuit. The user pays for the individual 56 kbps lines and the amount of the interoffice T1 utilized. In T1 access, the user pays for a full T1 to the IXC POP and then only for the bandwidth utilized.

TSU 600 OVERVIEW

A functional description of the T1 multiplexers, a description of the TSU 600 rear panel, and a summary of the features of the TSU 600 is provided in this section. The unit is shown in Figure 1-1.

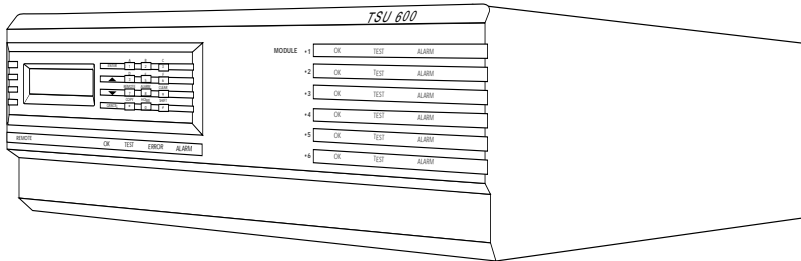

Figure 1-1
Front View of the TSU 600

Functional Description

The ADTRAN TSU 600 is one of several T1 multiplexers that offers complete flexibility for connection of various data sources to T1 or FT1 facilities. This family of TSU multiplexers includes the TSU, TSU 100, and the TSU 600.

TSU

The TSU is a T1 CSU/DSU with a single Nx56/64 serial port.

TSU 100

The TSU 100 is the same as the TSU with the added feature of a slot in the rear panel to house an option module. Each module offers up to four additional data ports.

TSU 600

The TSU 600 is the same as the TSU with the added feature of six slots in the rear panel to house up to six option modules. Each module offers up to four additional data ports for a total of 24 possible data ports.

The TSU 600 serves as the link between user data sources such as local area network (LAN) bridges and routers, computers, CAD systems, teleconferencing equipment, and PBXs. Through the use of multiple data ports, the TSU 600 can simultaneously connect one or more of these devices to a T1 circuit. The amount of bandwidth allocated to each port is custom programmable. The bandwidth allocation can be changed manually or set to automatically change at predetermined times to use the available bandwidth most advantageously. Changes in the configuration are accomplished without disrupting data flow in channels that are not being reconfigured. The unique architecture and the availability of the option modules provides a path for growth to accommodate future requirements.

Identification of Rear Panel Layout

The configuration of the rear panel of the TSU 600AC and TSU 600DC is shown in Figure 1-2.

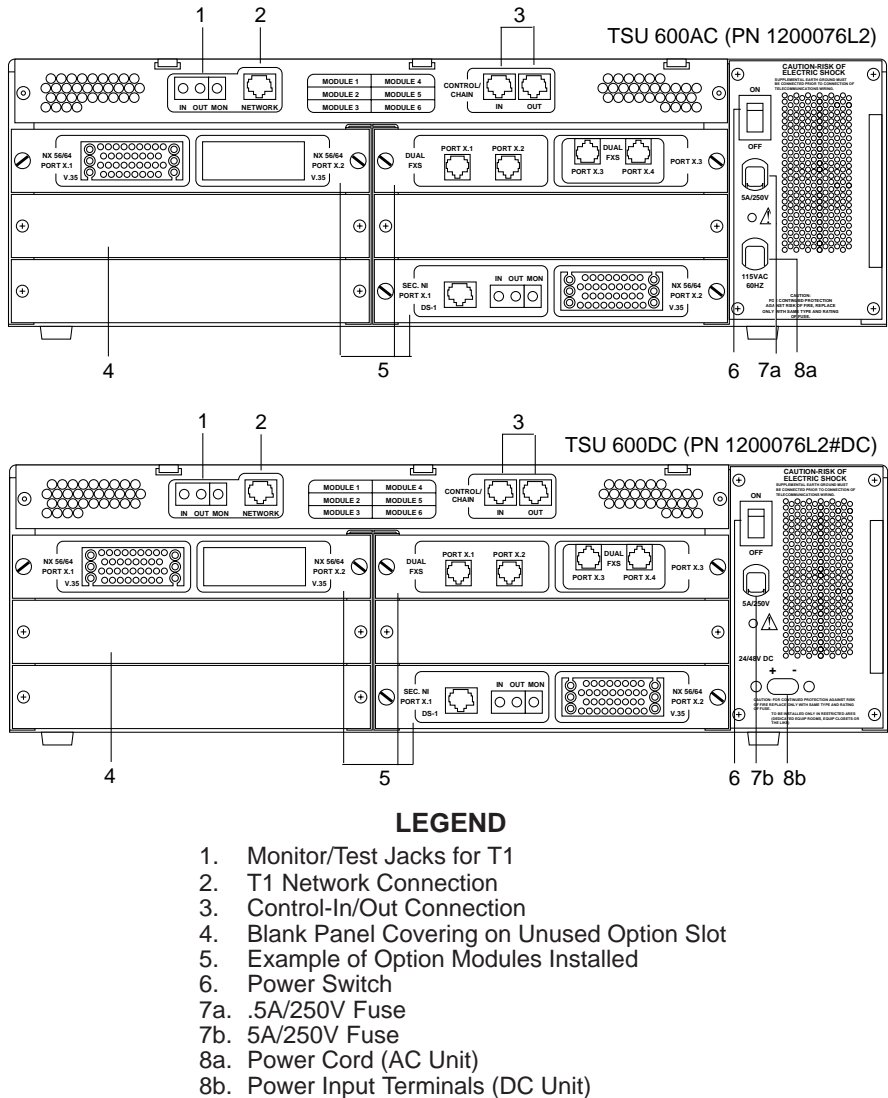

Figure 1-2
TSU 600 Rear Panel

Features of the TSU 600

The TSU 600 offers the following features:

- A DS1 interface and a 60 Hz or DC (optional) power supply.
- Six slots to house option modules with up to four additional data ports, including voice.
- Allows mix of port types to meet the data interface requirements.
- Easy configuration capabilities using simplistic menus displayed in a liquid crystal display (LCD) window operated by a front panel keypad.
- Two programmable configuration maps that define the bandwidth allocation between data ports.
- Second DS1 interface provides three Mbit aggregate throughput.
- Data drop and insert, as well as full drop and insert.
- Flash memory for software updates.
- Timing is selectable from the network, from the slot 1 data port, internally, or from a secondary interface.
- QRSS; 511 test patterns using Nx option.
- Extensive self test and monitoring provides assurance of proper operation.

TSU INTERFACES

The TSU 600 is equipped with six slots in the rear panel to house option modules which provide a variety of additional data ports. See Figure 1-3.

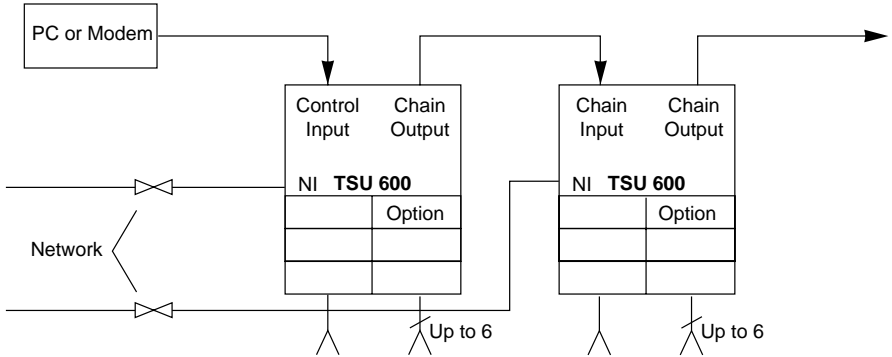

Figure 1-3
TSU 600 Interfaces

Network Interface

The Network Interface (NI) port complies with the applicable ANSI and AT&T standards.

The NI provides the following functions:

- AMI or B8ZS coding
- Automatic or manual line build out
- D4 or ESF framing
- Network performance monitoring and reporting
- Test loopbacks with QRSS generation and checking
- Extensive self test

Control Port Input

The control port input provides the following functions:

- RS-232 input from a PC or a modem for control of the TSU 600
- Chain input from another TSU 600 or TSU 100
- Up to 9600 baud operation
- Acts as input for PC control or as input for a chained connection
- Input for flash memory software downloads

Chain Port Output

The chain port output provides the following functions:

- RS-232 output to chain control to other TSUs
- Up to 9600 baud operations
- Automatic setup; no user input required

THREE METHODS OF CONTROL

Front Panel

The front panel provides complete and easy control of all items that can be configured through menu guided options. The front panel LCD also displays the status of operation and performance reports for the unit. A complete discussion of the operation of the front panel and all the menu options is found in the chapter *Operation*.

ADTRAN PC Program

T-Watch is the ADTRAN PC control program for Microsoft Windows®. It provides complete control over the configuration of the TSU 600 using a graphic interface. The T-Watch program displays the same status and performance data as the front panel LCD. These data are displayed in the form of tables and graphs.

The T-Watch program has the following capabilities:

- Interfaces with a modem which permits dialing into a remote TSU 600 location to configure the unit or read the unit's status or performance.
- Receives traps from the TSU 100 network alarm.

SNMP

The ADTRAN TSU 600 is designed to support the Simple Network Management Protocol (SNMP) through an ADTRAN ADVISOR. The proxy agent runs on a PC and can interface to the TSU 600 directly or through a modem, in the same manner as the T-Watch PC program.

OPTION SLOT ARRANGEMENT

As viewed from the rear of the TSU 600, the slots are numbered as shown in Figure 1-4. All slots are functionally identical except slots one and six. These slots offer additional functions.

Slot 1

Slot 1 is used as the source of DTE timing when the DTE timing mode is selected. If DTE timing is desired, the DTE interface port sourcing the timing must be connected to Slot 1. This slot will accept all other interface types except Secondary Network interface option modules, including DSX-1 (PBX), the Full Drop and Insert (D&I) network interface, or the Dial Backup (DBU).

Slot 2

Slot 2 is used for the Dial Backup module if a DBU is installed. This slot accepts all other interface types except Secondary Network interface option modules, including DSX-1 (PBX) and the Full Drop and Insert (D&I) network interface.

Slots 3-5

Slots 3-5 will accept any interface type except secondary interface, the interface for DTE timing, or the DBU. If other interfaces have any restriction on their location, this will be specified in the individual option card manual (provided with the option cards).

Slot 6

Slot 6 services any option module type including secondary network interface ports (DSX-1 (PBX) and Full D&I), but not the DTE timing source. If a secondary network interface port is to be used, it must be installed in slot 6.

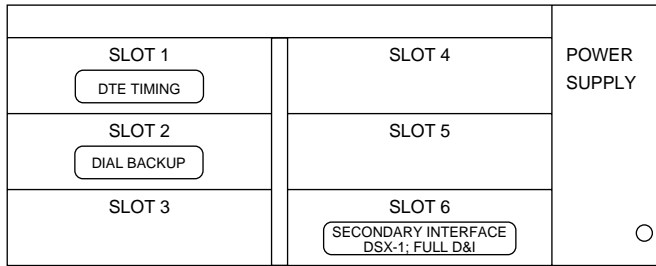

Figure 1-4
TSU 600 Option Slot Arrangement

OPTION PORTS

The option ports vary depending on the option modules installed.

Secondary Interfaces (SI)

The secondary interface is an additional interface to a DS1, a DSX1 facility, or some other network service, and it offers a source of timing. The type of interface depends on the option module installed. The interface includes the following:

- DSX1. Passthru for operation with a PBX (Terminal Interface - TI).
- Full Drop and Insert. Permits the dropping of data and insertion of new data into the same DS0 time slot. This SI module includes a long haul DS1 interface. It can also be used as a second DS1 interface to provide an up to 3 Mbit aggregate throughput.

Other Data Interfaces

Additional data interfaces can be installed in the option slot, and include the following:

- Nx56/64 serial interface. This module is the same as the base Nx interface but offers single or dual V.35 ports.
- Voice interface. 2/4 channel FXS/FX0/E&M.
- OCU DP. Interfaces to DDS or 4-wire Switched 56.
- Dial backup.

TSU 600 CLOCK SOURCES

The TSU 600 is operable from various clock sources permitting it to perform properly in many different applications. The network interface clocking options are set by using the clocking options set by using the Network (NI) Configuration menu options. The following clock source options are available:

- Network
- DTE timing
- Internal timing
- Secondary timed
- Normal (CSU)



NOTE

Network Timed

The clock option selected always designates the clock source for transmission. Clocking necessary for receiving data is always recovered from incoming data.

The network is the source of timing. The received data clocking is looped back to the network where it is used to determine the transmission timing. This option is also referred to as *loop timed* as the transmission clock is derived from the received clock. See Figure 1-5.

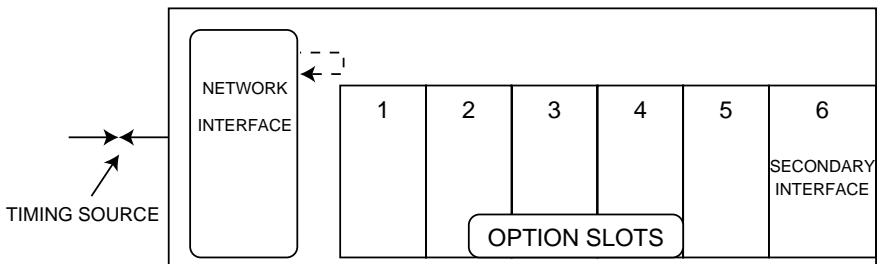

Figure 1-5
Network Timed Clock Source

DTE Timed

The DTE is the source of timing. The TSU 600 uses the incoming DTE clock to determine the transmission timing. This is typically used in applications where it is necessary to have the DTE as the primary clock source, (such as limited distance line drivers). See Figure 1-6.



The DTE source timing is restricted from use when a secondary interface is used at the same time.

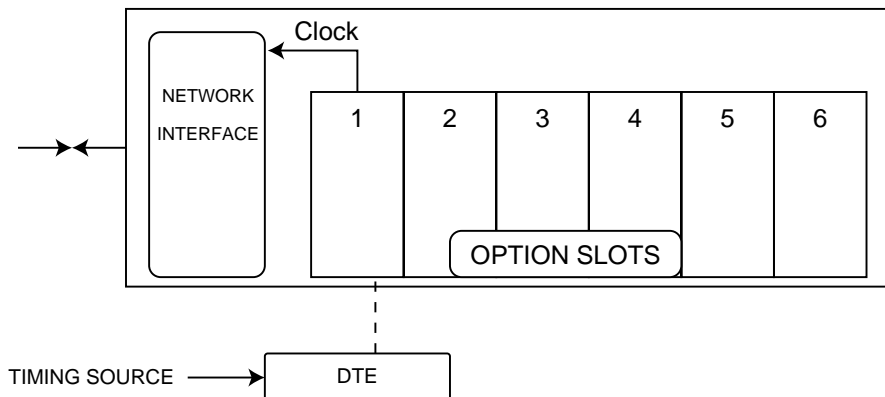

Figure 1-6
DTE Clock Source

Internal Timing

The TSU 600 is the source of timing. The TSU 600 is configured to use its own internal oscillator as the source of timing. Applications include private line driver circuits where one end is set to network and the other to internal. See Figure 1-7.



NOTE

The internal source timing is restricted from use when a secondary interface is also used.

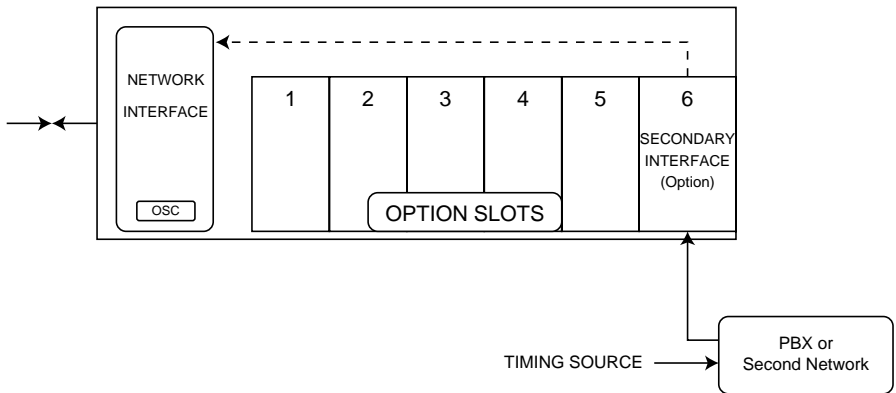

Figure 1-7
Internal Clock Source

Normal (CSU) Timing

The typical timing option arrangement is shown in Figure 1-8. The PBX is looped timed sending data to the TSU 100 which is actually synchronous to the received data. The Network Interface (NI) is the actual source of all timings. This timing option is the same as that typically used for CSUs. This is the preferred mode for use with a PBX application.

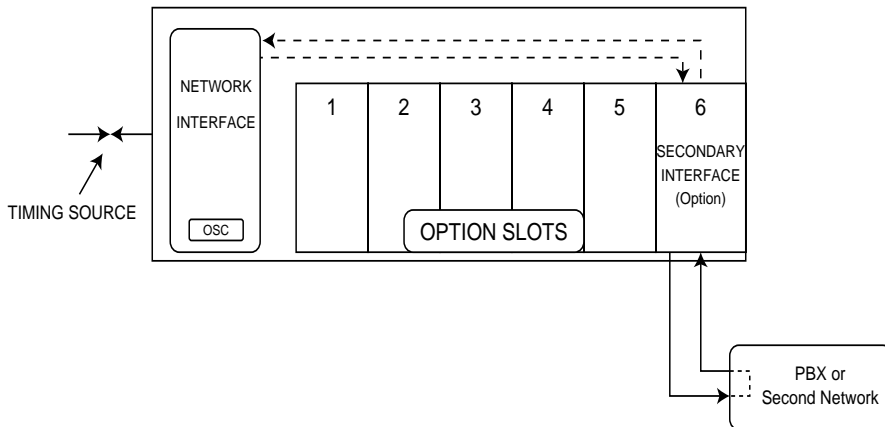

Figure 1-8
Normal (CSU)



The network interface and secondary interface clocking options are set by using the Network (NI) Configuration menu options.

TSU 600 TESTING

The TSU 600 offers three forms of testing:

- Self test
- Loopback tests (local and remote)
- Pattern generation and check

Self Tests

The self test checks the integrity of the internal operation of the electronic components by performing memory tests and by sending and verifying data test patterns through all internal interfaces. Although actual user data cannot be passed during these tests, the self test can be run with the network and DTE interfaces in place and will not disturb any external interface.

The memory portion of the self test automatically executes upon power up. A full self test can be commanded from a front panel menu or from T-Watch.

In addition to the specified self tests, background tests are also run on various parts of the internal electronics. These run during normal operation to confirm continued correct functioning. The background tests include: (1) monitoring the phase locked loop for lock, (2) sending test data through a parallel path which is looped back and verified, and (3) the standard background network performance monitoring, as required by ANSI T1.403 and AT&T 54016 specifications for which the results are stored.

Loopback Tests

A number of different loopbacks can be invoked locally from the front panel, by T-Watch commands, or remotely by using special in-band codes (AT&T D4 network loop up and loop down codes; V.54 loop up/loop down codes for the Nx56/64 serial interface). Additionally, the loopbacks can be remotely controlled by means of out-of-band commands by the T1 ESF FDL or from T-Watch by a modem connection.

Classes of Loopbacks

There are two classes of loopbacks: network interface and DTE interface.

Network Interface Loopbacks

Network interface loopbacks (see Figure 1-9) affect the entire T1 data stream. There are two types of network loopbacks, line loopback and payload loopback.

Line loopback loops all of the received data back toward the network. The transmitted data is the identical line code that was received, including any bipolar violations or framing errors.

Payload loopback is similar to line loopback, except that the framing is extracted from the received data and then regenerated for the transmitted data.

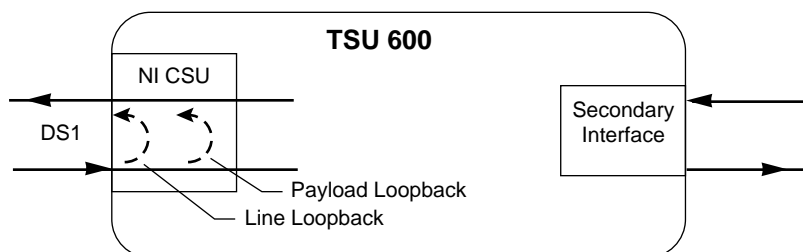

Figure 1-9
Network Loopback Tests

DTE Interface Loopbacks

DTE interface loopbacks affect only that portion of the data stream programmed to that particular interface port. The Nx56/64 serial interface offers two loopbacks, a DTE loopback and a port loopback. See Figures 1-10 and 1-11.

DTE loopback loops all data from the DTE back towards the DTE. This loopback occurs just past the interface circuit allowing a verification of the operation of the DTE to TSU 600. This loopback may be initiated by using front panel or T-Watch commands. The DTE (or external test equipment) must provide any test pattern in order to check the DTE interface. See Figure 1-10.

**NOTE**

The TSU 600 also activates a port loopback when the DTE loopback is asserted.

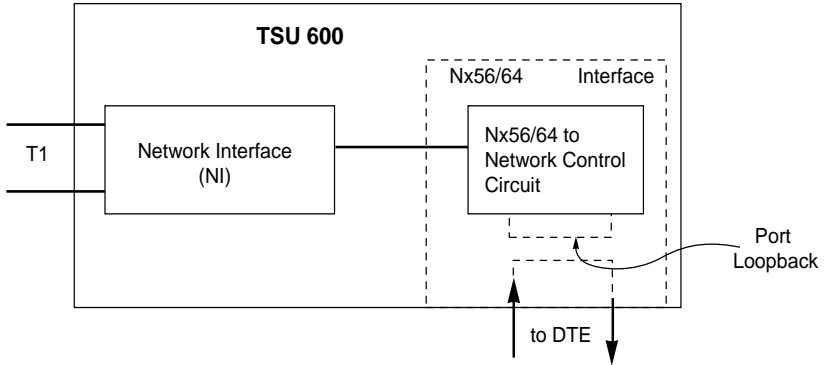

Figure 1-10
DTE Interface Loopback

Port loopback loops that portion of the network bandwidth programmed for a port back toward the network. This loopback occurs within the port electronics, but before the DTE interface. See Figure 1-11. The port loopback also automatically activates the DTE loopback looping the DTE data back on itself. The port loopback is activated by command from the front panel or from the T-Watch program. This causes a V.54 loopback code to be sent to the far end unit.

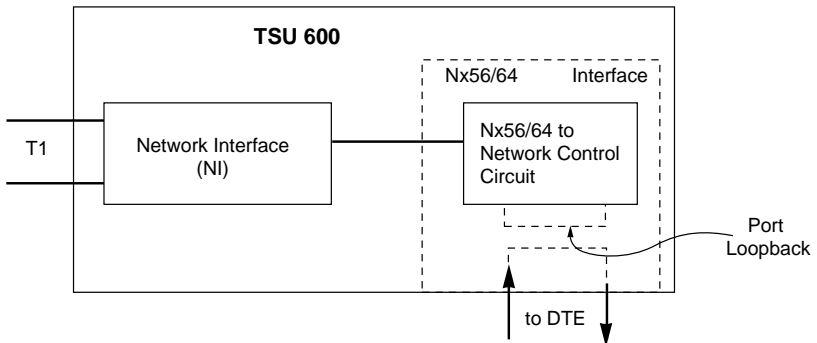

Figure 1-11
Port Interface Loopback

Pattern Generation

The TSU 600 offers two available test patterns: QRSS and 511.

QRSS Pattern

The QRSS pattern is commonly used to simulate real data in T1 interfaces. This pattern can be assigned to appear in all DS0s or only in TST DS0s. When QRSS is set in all DS0s and one of the network loopbacks previously described is activated at the far end, a total end-to-end integrity check can be run without the need for any external test equipment. When QRSS is assigned to TST DS0s, an integrity check of the link can be run along with normal data flow. The TST DS0s are user assigned as part of the DS0 Map.

511 Pattern

The 511 pattern is generated and checked by an Nx56/64 serial interface option card. It only appears in the DS0s assigned to the Nx56/64 port which is generating the pattern. When used in conjunction with the port loopback at the far end as previously described, an end-to-end integrity check can be made on the DTE ports.

TSU 600 CONFIGURATION APPLICATIONS

The following examples illustrate possible configurations of TSU 600 applications.

TSU 600 Option Modules

The TSU 600 features a unique architecture that allows the addition of six option modules and plug on boards providing an opportunity for growth to accommodate many applications (see Figure -12).

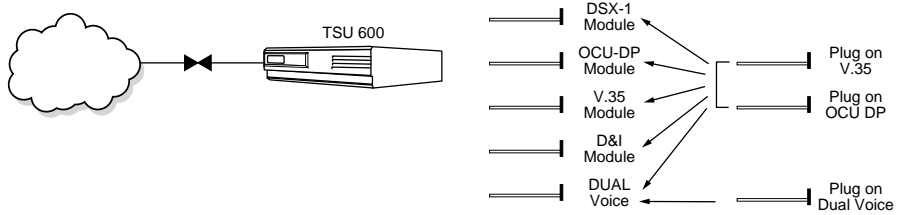

Figure 1-12

TSU 600 Option Modules

Bridge, PBX, Video Conferencing Application

In this application an Nx54/64 module provides a V.35 interface to a bridge. The PBX is interfaced to the TSU 600 with the DSX-1 module. Two switched 56 circuits are provided by an OCU DP module and OCU DP plug on board. See Figure 1-13.

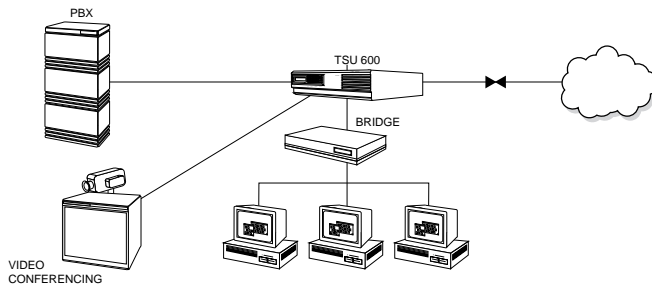

Figure 1-13

Bridge, PBX, Video Conferencing Application Set Up

All Voice Application

In this application 24 voice channels are provided for telephones and for fax machines. Six FXS dual modules with six dual FXS plug on boards provide the voice interfaces. See Figure 1-14.

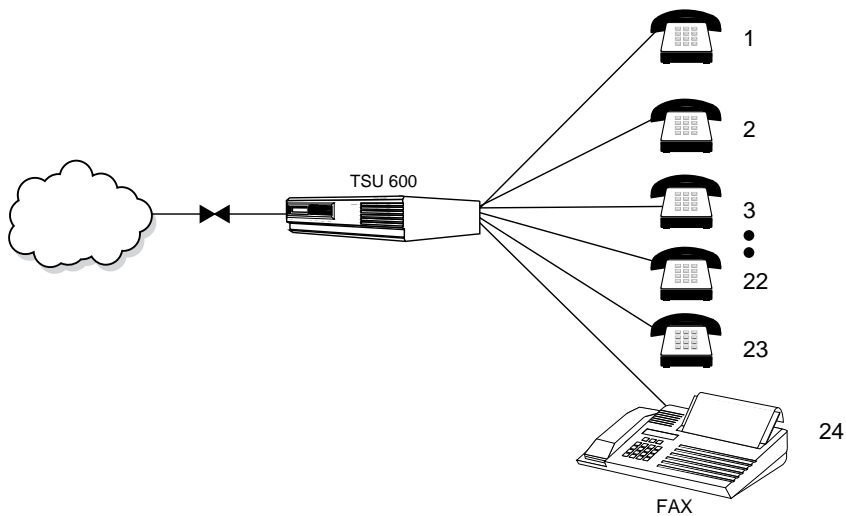

Figure 1-14
All Voice Application Set Up

Drop and Insert, Voice, and Bridging Application

The TSU 600 provides a bridge interface with an Nx56/64 module. A drop and insert module provides an interface to a remote TSU 100. The OCU DP module is used for a 56 kbps DDS circuit to a remote warehouse. The network is easily managed with T-Watch which is run on a PC. See Figure 1-15.

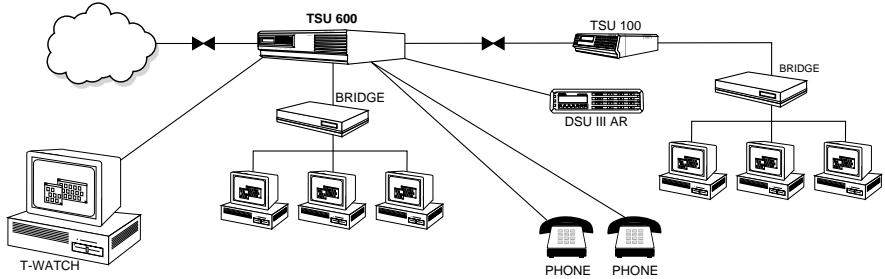

Figure 1-15

Drop and Insert, Voice, and Bridging Application Set Up

Variations of Mixed Applications

Regional Sales Office

TSU 600 supports LAN bridge with base Nx. The PBX uses a DSX-1 module. Video conferencing is interfaced by use of the plug-on V.35 interface. See Figure 1-16.

Branch Office

TSU 600 supporting LAN bridge with base Nx. The KEY system uses the DSX-1 module. See Figure 1-16.

Corporate

TSU 600 supports LAN bridge with base Nx. The PBX system uses the DSX-1 module. The plug-on V.35 is used to interface to the video telecom equipment. See Figure 1-16.

T-Watch Management Software

The T-Watch software runs under Microsoft Windows allowing full access to local and remote TSU units. Test, monitor, and performance information is available with pull down menus. It is possible to dial into the system with a modem or to access remote units via the FDL. See Figure 1-16.

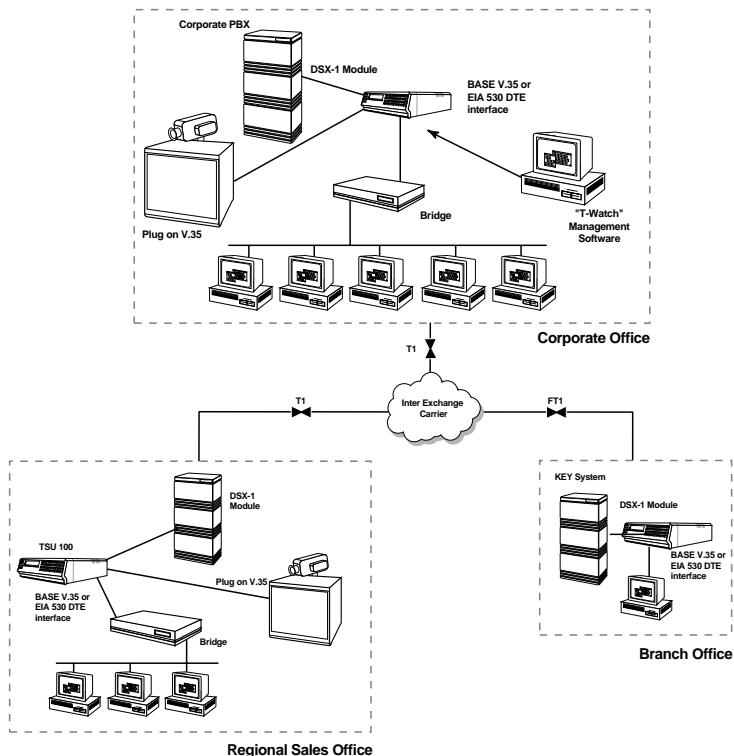

Figure 1-16
Variations of Mixed Applications

Chapter 2

Installation

UNPACK, INSPECT, POWER CONNECTION

Carefully inspect the TSU 600 for any shipping damages. If damage is suspected, file a claim immediately with the carrier and then contact ADTRAN Customer Service (see the last page of this manual). If possible, keep the original shipping container for use in shipping the TSU 600 back for repair or for verification of damage during shipment.

Shipped by ADTRAN

The following items are included in the ADTRAN shipment:

- The TSU 600
- A line interface cable: an 8-position modular to 8-position modular
- The user manual

Provided by Customer

The following items must be supplied by the customer:

- DTE cable(s)
- Cables for any expansion modules to be used with the TSU 600

Power Connection

The AC powered TSU 600 is equipped with a captive eight-foot power cord, terminated by a three-prong plug which connects to a grounded power receptacle.

Power to the TSU 600 must be from a grounded 115 VAC, 60 Hz source.

DC Powered Units

The DC powered TSU 600 (1200.076L2#DC) is equipped with a terminal strip on the rear of the unit. The power source should be connected to the terminal strip according to the polarity markings on the unit. For example, a -48V source would be connected with the -48V return attached to the (+) terminal and the -48V DC attached to the (-) terminal. Power must be from a DC source in the range of 21 to 26V DC or in the range of 40 - 56V DC.

The chassis ground connection on the rear panel is electrically isolated from the power input. The protective cover should be reinstalled over the terminal strip, once the power source is connected.

The DC powered TSU 600 is to be installed only in restricted areas (dedicated equipment rooms, equipment closets, or the like) in accordance with Articles 110-16 and 110-18 of the National Electric Code, ANSI/NFPA 70.

WARRANTY AND CUSTOMER SERVICE

ADTRAN will replace or repair this product within five years from the date of shipment if the product does not meet its published specifications or if it fails while in service. For detailed warranty, repair, and return information refer to the ADTRAN Equipment Warranty and Repair and Return Policy Procedure.

Return Material Authorization (RMA) is required prior to returning equipment to ADTRAN.

For Service, RMA requests, or more information, contact ADTRAN Customer Service listed on the inside back cover of this manual.

GROUNDING INSTRUCTIONS (UL 1459)

Grounding instruction information from the Underwriters' Laboratory *UL 1459 Standard for Safety: Telephone Equipment*, of September 20, 1993, is provided in this section.

An equipment grounding conductor that is not smaller in size than the ungrounded branch-circuit supply conductors is to be installed as part of the circuit that supplies the product or system. Bare, covered, or insulated grounding conductors are acceptable. Individually covered or insulated equipment grounding conductors shall have a continuous outer finish that is either green, or green with one or more yellow stripes. The equipment grounding conductor is to be connected to ground at the service equipment.

The attachment-plug receptacles in the vicinity of the product or system are all to be of a grounding type, and the equipment grounding conductors serving these receptacles are to be connected to earth ground at the service equipment.

A supplementary equipment grounding conductor shall be installed between the product or system and ground that is in addition to the equipment grounding conductor in the power supply cord on AC units.

The supplementary equipment grounding conductor shall not be smaller in size than the ungrounded branch-circuit supply conductors. The supplementary equipment grounding conductor shall be connected to the product at the terminal provided, and shall be connected to ground in a manner that will retain the ground connection when the product is unplugged from the receptacle. The connection to ground of the supplementary equipment grounding conductor shall be in compliance with the rules for terminating bonding jumpers at Part K or Article 250 of the Na-

tional Electrical Code, ANSI/NFPA 70. Termination of the supplementary equipment grounding conductor is permitted to be made to building steel, to a metal electrical raceway system, or to any grounded item that is permanently and reliably connected to the electrical service equipment ground.

Bare, covered, or insulated grounding conductors are acceptable. A covered or insulated grounding conductor shall have a continuous outer finish that is either green, or green with one or more yellow stripes.

WIRING

Network

On the rear panel the TSU 600 is an eight-position modular jack labeled NETWORK. This connector is used for connecting to the network. See Table 2-A for the pinout for the network connector.

Connections

The network connections are as follows:

Connector type (USOC) RJ-48C
Part number AMP# 555164-2

Table 2-A
Network Pinout

PIN	NAME	DESCRIPTION
1	R1 RXDATA-RING	Receive data from the network
2	T1 RXDATA-TIP	Receive data from the network
3	UNUSED	
4	R TXDATA-RING	Send data toward the network
5	T TXDATA-TIP	Send data toward the network
6,7,8	UNUSED	

Control In/Chain-in

This is used as an RS-232 port for connection to a computer or modem (Control In) or to another TSU 600 or TSU 100 (Chain-in). See Table 2-B for the pinout for the control/chain-in connector.

Connections

The chain-in connections are as follows:

Connector type RJ-48
Part number AMP# 555164-2

Table 2-B
Control In/Chain-in Pinout

PIN	NAME	DESCRIPTION
1	GND	Ground - connected to unit chassis
2	RTS	Request to send - flow control
3	RXDATA	Data received by the TSU 600
4	UNUSED	
5	TXDATA	Data transmitted by the TSU 600
6,7	UNUSED	
8	CTS	Clear to send-flow control

Chain-out

This is used to connect to another TSU 600 Chain-in connector. See Table 2-C for the pinout for the chain-out connector.

Connections

The chain-out connections are as follows:

Connector type RJ-48
Part number AMP# 555164-2

Table 2-C
Chain-out Pinout

PIN	NAME	DESCRIPTION
1	GND	Ground - connected to unit chassis. Connected to GND of next unit (pin 1).
2	UNUSED	
3	TX DATA	Data transmitted to chained units by the TSU 600. Connect to RX DATA of the next unit (chain in pin 3).
4	UNUSED	
5	RX DATA	Data received from chained units by the TSU 600. Connect to TX DATA of the next unit (chain in pin 5).
6,7,8	UNUSED	

POWER UP TESTING AND INITIALIZATION

When shipped from the factory, the TSU 600 is set to factory default conditions. At the first application of power, the unit automatically executes a memory self test. A full self test can be run from the front panel, and a pass code and unit ID may be set using the UTIL menu.

Self Test

Upon a power-up, the LCD displays **Memory Test Now Testing** and the Test LEDs are illuminated. When the self test is completed with no failures detected, the OK LED lights up and the LCD momentarily displays **All Tests Passed**. If a failure is detected, a list of failures is displayed in the LCD window. The full self test procedure (invoked from the front panel or T-Watch) consists of the following steps:

1. Board level tests. Each of the TSU 600 boards contains an on board processor which executes a series of tests checking the circuitry on the board.
 - a. RAM tests; EPROM checksum.
 - b. DS0 map tests.
 - c. On board data path. Sending a known test pattern through an on board loop.
2. Unit level tests.
 - a. Front panel LED verification.
 - b. Phase lock loop verify.
 - c. Board-to-board interface test. A test pattern is sent from the controller through a loopback on all other boards and checked on the controller. This verifies the data path, clocks, and control signals.

Set User Passcode

The TSU 600 is designed to operate with or without the use of a password.



NOTE

The passcode should be a number easily remembered. Once entered, the passcode is required to access any operation other than viewing.

To Establish a Passcode

Select SET PASSCODE (item 3) under the UTIL menu. At the New Passcode prompt, use numbers from the front panel of the keyboard to enter a unique number up to four (4) digits.

After pressing **Enter** a verification prompt is displayed. Respond to the verification prompt by repeating the same passcode number.

If the two entries match, the unit accepts the passcode. If they do not match the unit returns to the new passcode entry field for another attempt.



NOTE

If the unit is to be remotely accessed using T-Watch, a passcode must be entered. When managing a number of units, the passcode can be the same for all.

Special Feature

For added security protection the unit is equipped with an automatic time out for operation with the password. After ten minutes of inactivity, the unit reverts to limited access operation. To make changes in the configuration, the passcode can be reentered. See *Passcode* in the chapter *Operation* for further information concerning passcode use, and both limited and editing access.



NOTE

If the passcode number is lost, contact ADTRAN Customer Service for assistance.

No Passcode Desired

At the New Passcode prompt (in the Set Passcode menu), press **Enter** without any numerical entry. The system nullifies the need to enter a password for subsequent use and proceeds to the Unit ID prompt.

Set Unit Identification

The Unit ID sets the unit to respond to remote control (controlled by a device other than the front panel). If no Unit ID is recorded it is not possible to operate from any remote control device, including the local PC.

To Set the Unit Identification

In the Unit ID menu (item 4) under the UTIL menu, enter any value between 2 and 250. The number 1 is reserved for the PC.

Pressing **Enter** records the Unit ID number and establishes its availability for operation by remote control. The unit proceeds to the **Set Control Port** prompt.

No Unit ID Desired

Without entering any numbers at the **Unit ID** prompt, press **Enter**. Pressing **Enter** with no Unit ID recorded establishes the unit as not able to be operated by remote control.

Set Control Port

The TSU 600 can be configured from the control port only when a unit ID number has been entered. (It can be configured from the faceplate whether a unit ID number has been entered or not.)

If the control port is to be used, the control port baud rate must also be selected.

Possible uses of the control port are control in and chain-in.

Control In (PC)

The unit can be controlled from an external PC connected directly or via modem to the Control In port. When using Control In, the selection of the Control Port baud rate from 9600 (factory default), 1200, 2400, or 4800 must be made using the Unit Configuration menu.

Unless locked out externally, the front panel can also control the unit.

Chain-in

TSU 600s and TSU 100s can be linked together to form a chain. Figure 2-1 provides an example of a chain-in arrangement with a PC or a modem. The first TSU 600 in the chain receives controlling input from the PC or modem.

Subsequent TSUs in the chain are in a position to intake information from another TSU. This in-taking of information from another TSU in the chain is identified as Chain-in. The baud rate for the chained units must match that of the first unit.

Unless locked out externally, the front panel can also control the unit.

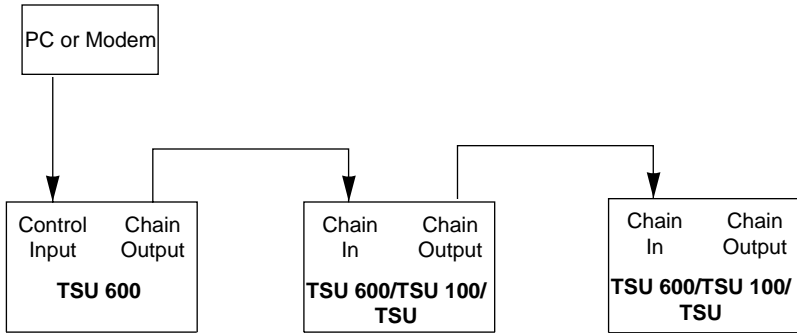

Figure 2-1
Example of Chain-in

At this point, the Unit Initialization procedure is concluded. If the unit is to be configured remotely, there are no additional items necessary to complete prior to executing remote configuration.



The Passcode, the Unit ID, and the Control Port settings are stored in a nonvolatile memory. This assures they are operable for subsequent power-up sequences.

Normal Power-Up Procedure

After the unit has been put into operation with the initial power-up and initialization, subsequent power-up procedure includes only the Power-Up Self Test followed by the request for a passcode (password) if this option was selected during initialization.

Use the number keys to enter the previously recorded passcode followed by pressing **Enter**.

Correct Passcode

When a correct passcode is entered, the message **Access Granted** is displayed and the unit grants full access privileges. Press any key to proceed to the opening menu.

Incorrect Passcode

When an incorrect passcode is entered, the message **Incorrect** is displayed. Press any key to return to the passcode prompt.

No Passcode

When no passcode is entered the message **Limited Access** is displayed and the unit grants limited access to the menu system for viewing only. Pressing any key proceeds to the Main menu. No changes are allowed until the correct passcode is entered.

The passcode can also be entered using the Utility menu option.

Chapter 3

Operation

OPERATION

The TSU 600 can be configured and controlled by two different methods: front panel operation or the optional control software called T-Watch.

Identification of Front Panel Layout

The TSU 600 front panel is used to both monitor operation and control the configuration of the unit. The display panels and operation keys on the TSU 600 front panel are identified in Figure 3-1.

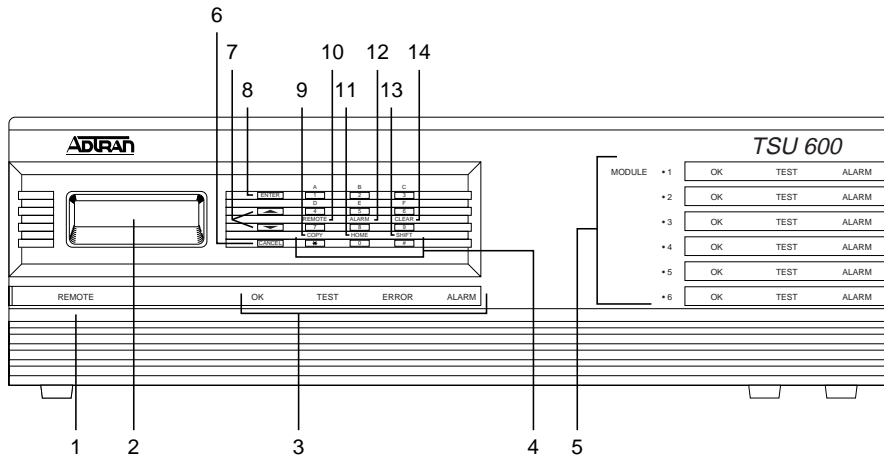

- | | |
|---------------------------|------------|
| 1. REMOTE | 8. ENTER |
| 2. LCD Window | 9. COPY |
| 3. CSU Status | 10. REMOTE |
| 4. Key Pad | 11. HOME |
| 5. Module Status | 12. ALARM |
| 6. CANCEL | 13. SHIFT |
| 7. Up and Down Arrow Keys | 14. CLEAR |

Figure 3-1
TSU 600 Front Panel Layout

The display panels and operation keys called out in Figure 3-1 are described in the following sections:

Display Panels

Remote

When illuminated, this panel indicates that the TSU 600 is accessed remotely by the PC program.

Module Status

The module status LEDs display the operational condition of ports installed in the option slots.

- **OK (green)**
Indicates the operation is in the normal mode and no errors have been detected.

- **Test** (yellow)
Indicates that one of the interfaces is operating in a test mode. This includes a self test or a test loop-back. When lighted, this LED also indicates that normal data flow is not occurring in at least one of the module ports.
- **Alarm** (red)
Indicates an alarm condition has been detected. When the alarm condition is no longer valid, the OK LED activates (turns on). To view an alarm condition, select the active alarm menu item or select Alarm by pressing **shift 8**. If the alarm conditions have been corrected, the alarm which caused the activation of the Alarm LED can be viewed under the Unit History menu.

LCD Window

A 2x16 character backlit LCD window displays menu items used in the configuration of the unit. It also displays alarm and status information.

CSU Status

Indicates the status of the network interface located on the controller board in the unit. These LEDs show the same indication as the Module, with the addition of the Error LED. The Error LED indicates an error such as BPV, OOF, or CRC error.

Operation Keys

Copy

Used in the DS0 mapping menu operations to copy the last data entered into the current DS0. This key operates without pressing the **Shift** key.

Remote

Reserved for future use.

Home

Used to return home to the Main menu from any menu location.

Alarm

Used as quick access to the active alarm display menus. This can be activated while any other menu item is in use. When the Alarm menu is exited, the unit returns to the location of the same menu that was active when Alarm was selected.

Shift

When pressed and held, causes the shift functions (identified above the keys) to be activated.

Clear

Used in various menus to clear data/result fields.

Cancel

Cancels the last operation or exits the current menu level to the next higher level. If a value on a menu was selected but not entered, **Cancel** terminates the function and restores the previous setting.

Enter

Activates menu selections. Enters data value selections into the system.

Up and Down Arrows

Moves cursor through the menus or scrolls through data selector lists.

Keypad

These nine keys have dual functions. The first function is indicated by the lettering on the key itself. This is a standard phone keypad. The second function is a shifted function accessed by pressing and holding the **shift key #** along with another key. The shift function is indicated by the lettering above the keys.

A, B, C, D, E, F

Used as needed to extend the menu selection fields.

2

Used to inject errors with a test pattern running.

General Menu Operation

The TSU 600 uses a multilevel menu structure containing both menu items and data fields. All menu operations and data are displayed in the LCD window. The menu items are numbered and can be viewed by scrolling with the Up and Down arrows.

- **Data Field**
A menu item followed by a **colon (:)** identifies a data field that can be edited.
- **Display Field**
A menu field followed by an **equal symbol (=)** identifies a field used for value display and is not available for editing.
- **Arrows**
Menus that display small up or down arrows in the lower right corner indicate there are more menu items than are viewable on a two-line LCD. The additional menu items are accessed with the up or down arrows. Undisplayed menu items are also available by using the appropriate menu number.

Select and Activate a Menu Item

Place the cursor on the desired menu item by pressing the number corresponding to the menu item or highlighting the menu item with the **Up** and **Down Arrow**. In this example place the cursor on 2)CONFIG. Then press **Enter** or the number a second time. See Figure 3-2.

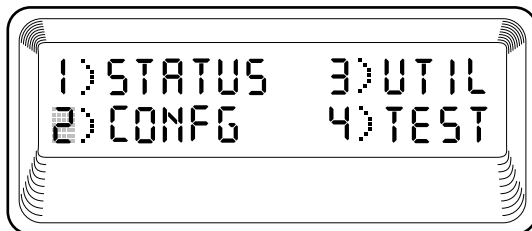

Figure 3-2
Select a Menu Item

The unit responds by displaying the first two sub-menu items (in this example, on the Configuration menu). An **Up** or **Down Arrow** shown in the lower right corner of the LCD indicates additional menu options in that direction. See Figure 3-3.

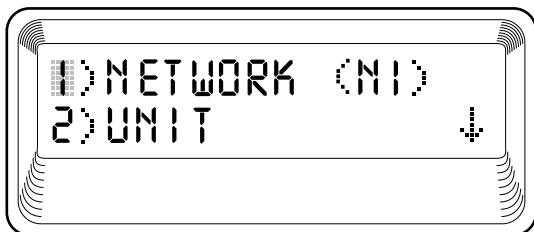

Figure 3-3
Sample Submenu

Set the Data Field

Data fields preceded by a colon (:) can be edited. See Figure 3-4.

With the cursor positioned on the submenu item number, press **Enter**. The cursor moves to the data field, (to the right of the submenu item name).

Using the arrows, scroll to scan the available value settings. The value settings display one-at-a-time in the data field position. When the desired value is displayed in the data field position, press **Enter** to set that value. When the value is set, the cursor moves back to the submenu item position indicating the operation is complete.

Another submenu field may be selected, or press **Cancel** to return to the submenu.

Pressing **Cancel** prior to pressing **Enter** voids any data changes. The original data value is restored and the cursor returns to the submenu field.

Display Only Data Fields

Data fields preceded by an equal (=) symbol cannot be edited. See Figure 3-4.

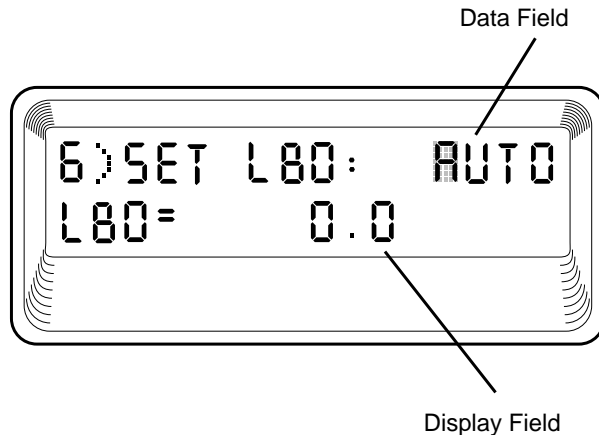

Figure 3-4
Display and Data Fields

Pressing **Enter** moves the cursor to the data field. Use arrows to select **AUTO** and press **Enter**. The unit automatically sets the Line Build Out. The display field shows the value actually set. The equal symbol after **LBO** in the second line indicates the information that follows is displayed data and cannot be edited.

Exit Any Menu Field Operation Or Display

Press **Cancel** as many times as required to return to the desired menu level or press **Home** to return to the main menu.

Data Port Identification

When configuring the unit, menu selections will include options from data port submenus. Selection of data ports is necessary because the TSU 600 uses a Slot-Port method to identify which data port the menu item is referencing. If a module containing a PBX

DSX-1 option card with an Nx56/64 plug-on interface is installed in option slot 6, it would be designated as:

DSX-1 Passthru=6.1

Where slot=6 and port =1.

The DSX-1 is located in option slot 6 and is the first port in that slot.

Nx56/64=6.2

Where slot=6 and port=2.

The Nx is located in Slot 6 and is the second port in that slot.

Viewed from the rear of the TSU 600, the module slots are arranged as shown in Figure 3-5.

		POWER SUPPLY
SLOT 1	SLOT 4	
SLOT 2	SLOT 5	
SLOT 3	SLOT 6	

Figure 3-5
Module Slots, TSU 600

MENU STRUCTURE

The TSU 600 uses a form of hierarchical menus to access all features. The topmost or Main menu level (see Figure 3-6) leads to submenus which are grouped by functionality. All menu operations are displayed in the LCD window as illustrated in Figure 3-7.



NOTE

The menu structure diagram, shown in Figure 3-6, is a limited overview. A detailed description of each menu item, presented in menu order, immediately follows. A complete menu diagram is shown in the appendix, TSU 600 Menu Tree.

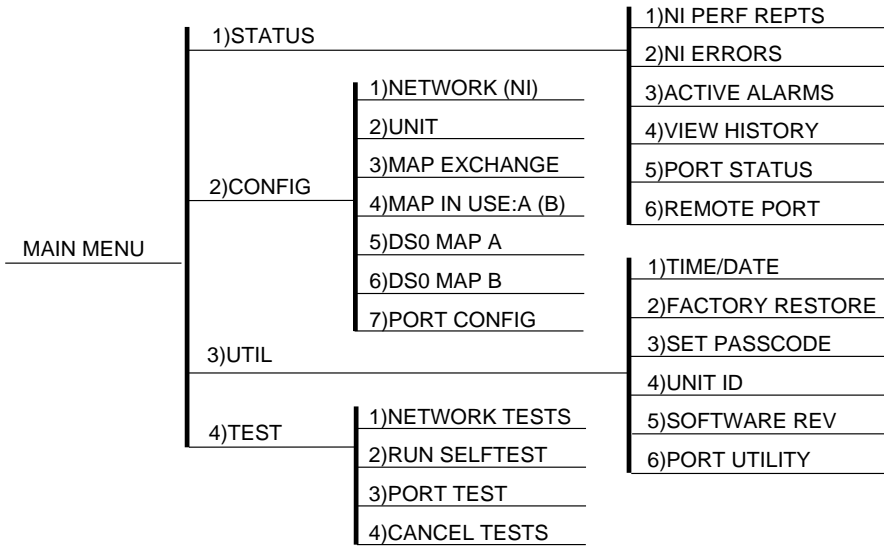

Figure 3-6
The Four Opening Menus

Menu flow is normally depicted from left to right. Arrows on the lower right of the screen indicate the direction of scrolling to use to view additional menu items. At every level of the menu pressing **Cancel** returns the system to the previous menu level. Pressing **Cancel** repeatedly returns the system to the Main menu.

The opening menu display as seen in Figure 3-7 is the access point to all other operations. There are four main menu items: Status, Configuration, Utility and Test. Each Main menu item has several functions and submenus to identify and access specific parameters. In the discussions that follow, each Main menu contains a complete menu diagram to identify the location of each operation.

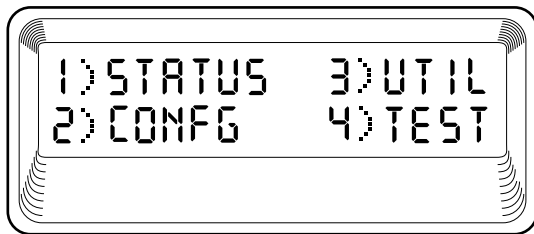

Figure 3-7
Display of Opening Menus

Opening Menu Functions

Status

The Status menu provides the ability to view the status of the TSU 600 operation. This menu includes the following items:

Network Interface Performance Reports (NI PERF RPTS)

Use this menu item to display user data on the NI Perf Rpts in compliance with ANSI T1.403 and AT&T Document TR54016.

Network Interface (NI) Errors

NI Errors indicate which errors are being detected at the network interface.

Active Alarms

This menu item displays current alarms which are currently reported by the TSU 600.

View History

This menu item displays date and time history of up to 20 status changes of the unit.

Port Status

Port Status is used for viewing the signals being monitored on the data ports.

Remote Port

Shows status of incoming commands on the chain-in port.

Configuration (CONFIG)

The Configuration menu is used to set the TSU 600 operational configuration. This menu includes the following items:

Network (NI)

This item is selected to set all of the parameters associated with the network interface located in the base unit.

Unit

Unit is used to set the TSU 600 control port baud rate and to set up the dial out function for network alarm traps.

Map Exchange (Map XCHNG)

This item sets up and activates an automatic DS0 map switch based on time of day.

Map In Use

This item is used to display and manually switch the DS0 map being used.

DS0 Map: A (B)

Selects DS0 Map (A or B) to designate which DS0s are assigned to which data port.

Port Configuration (Port Config)

This menu is used to configure the parameters associated with any data port in the unit.

Utility (UTIL)

The Utility menu is used to view and to set system parameters. This menu includes the following items:

Time/Date

Displays and can be used to set the time and date.

Factory Restore

Restores the factory default settings to all unit parameters. See the appendix, *System Configuration Chart*, for defaults.

Set Passcode

Allows a passcode to be added, changed, or deleted.

Unit ID

Displays and can be used to set the unit ID.

Software Revision (Software REV)

Displays the current software revision level loaded into the base unit controller. This information is required when requesting assistance from ADTRAN Technical Support or when updates are needed.

Test**NOTE**

The execution of tests will disrupt some normal operations. See individual menu items concerning tests before executing any.

The Test menu is used to initiate different types of tests of the unit and to view test results. Test results are displayed in the LCD window. The menu contains the following items:

Network Tests

Network Tests control the activation of loopbacks and the initiation of data test patterns.

Run Self Test

Run Self Test executes a full internal self test.

Port Test

Port Test is used to test specific data ports.

Cancel Tests

Cancel Tests deactivates all tests.

Opening Menu Functions: Detailed Discussion

The four opening menu functions, Status, Configuration, Utility, and Test, are discussed in great detail in the pages that follow.

STATUS

The Status menu branch provides the ability to view the status of the TSU 600 operation. See Figure 3-8.

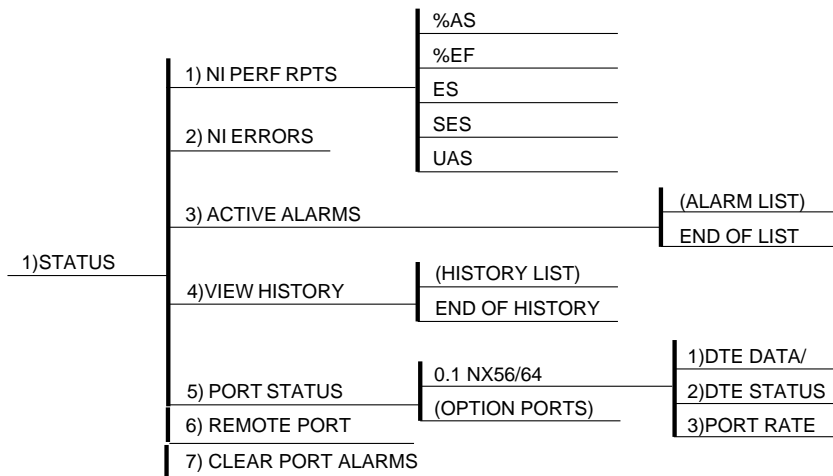

Figure 3-8
Complete Status Menu

Menu flow is normally depicted from left to right. Arrows on the lower right of the screen indicate the direction of scrolling to use to view additional menu items. At every level of the menu pressing **Cancel** returns the system to the previous menu level. Pressing **Cancel** repeatedly returns the system to the main menu.

Network Performance Reports (NI PERF RPTS)

The Network Interface Performance Reports display the user copy of the performance data. The TSU 600 maintains this performance data on the network in compliance with ANSI T1.403 and AT&T document TR54016. The data displayed is data accumulated over the last 15 minutes and over the last 24 hours.

With the cursor on Main menu item 1)STATUS, activate the menu with **Enter** or number **1**. The unit displays the first two Status submenu items with the cursor on 1)NI PERF RPTS.

Activate the selection with **Enter** or number **1**. The unit displays the first of five items in the Network Interface Performance report. See Figure 3-9. The equal symbol on the right of the item indicates a non-editable field follows.

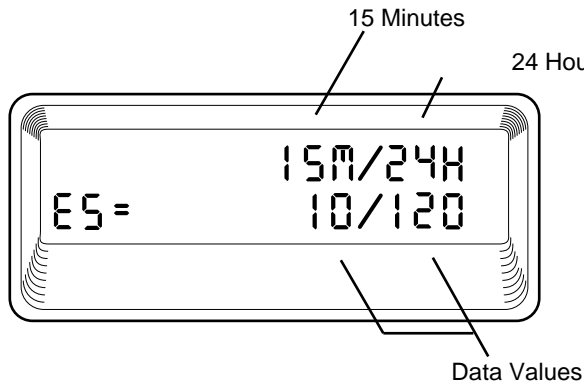

Figure 3-9
Network Interface Performance Report

Scroll keys are used to access the complete display of the following report fields:

%AS	% of available seconds
%EF	% of error free seconds
ES	Number of errored seconds (1 or more errors/second)

- SES** Number of severely errored seconds (more than 320 errors / second)
- UAS:** Number of unavailable seconds (10 or more consecutive seconds)

If insufficient time has passed to collect data, **NA** is displayed. Continue with standard operating procedures to exit the display.

When this menu is active, performance data can be cleared by pressing **Clear (shift 9)** on the keypad. Only the user copy of the performance data is cleared.



NOTE

Since only the user's copy of performance data is cleared by the TSU 600, the data displayed here might be different from the data sent to the network as PRM data.

Network Interface Errors (NI ERRORS)

The NI Errors submenu is used to view the type of errors detected by the Network Interface (NI). A blinking CSU error LED indicates that network errors are detected.

With the cursor on Main menu item 1)STATUS, activate the menu with **Enter** or number **1**. The unit displays the first two Status submenu items with the cursor on 1)NI PERF RPTS.

With the arrows or number **2**, select 2)NI ERRORS. Activate the selection with **Enter** or number **2**. The unit displays an asterisk (*) above an error type as in Figure 3-10.

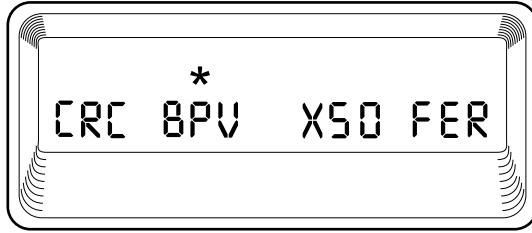

Figure 3-10
Network Interface Error Type

The asterisk (*) above an item indicates the type of errors detected. The error types are the following:

- CRC** CRC-6 bit errors based on the FDL. This is valid only in ESF mode.
- BPV** Bipolar violations.
- XS0** Excess zeros.
- FER** Framing errors.

Active Alarms

This menu item displays a list of current alarms reported by either the base controller or any of the ports. If no alarms are current, using this menu item displays **End of List**.

This display includes two lines of text. The top line is the alarm source. The bottom line is the alarm message. A list of alarm messages is found in the appendix, *TSU 600 System Messages*.

With the cursor on Main menu item 1)STATUS, activate the menu with **Enter** or number **1**. The unit displays the first two Status submenu items with the cursor on 1)NI PERF RPTS.

With the **arrows** or number **3**, select 3)Alarms. Activate the selection with **Enter** or number **3**. The unit begins the display of alarm messages and their identified source. See Figure 3-11. Continue with standard operating procedures to exit the display.

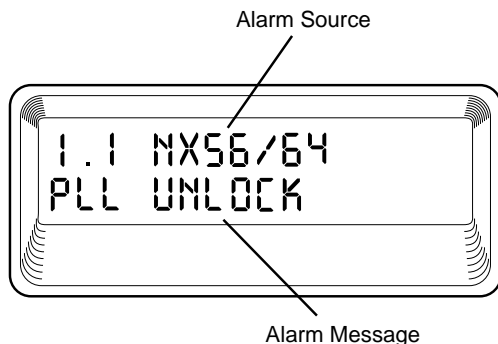
**Figure 3-11***Display of Alarm Messages***NOTE**

View History

*In addition to normal menu operation, entry to this menu item is gained by using the Alarm function (**shift 8**) on the keypad. The presence of an alarm is indicated by one or more of the Alarm LEDs being illuminated. Pressing Cancel will return to the menu item which was viewed when Alarm (**shift 8**) was initiated.*

This menu item is used to both view and clear the accumulated status changes of the unit.

View History displays a history of 20 status changes in the unit, including the date, time, and type of change. The unit also records for viewing the date and time an alarm became active and when it became inactive, as well as the date and time of test activation and deactivation.

To clear the View History display press **Clear (shift 9)** with the View History menu active.

Port Status

Port Status is used to view the signals monitored on the data ports. For example, an Nx56/64 interface monitors the RTS, CTS, TD, and RD, along with other signal lines. When a port is selected, the LCD indicates if the signal is present.

With the cursor on Main menu item 1)STATUS, activate the menu with **Enter** or number **1**. The unit displays the first two Status submenu items with the cursor on
1)NI PERF RPTS.

With the arrows or number **5**, select 5)PORT STATUS. Activate the selection with **Enter** or number **5**. The unit begins the display of available ports.

Remote Port

Selecting Remote Port status allows viewing of the status of activity on the Control In remote port. This is useful for troubleshooting communication sessions, as well as verifying cabling.

With the cursor on Main menu item 1)STATUS, activate the menu with **Enter** or number **1**. The unit displays the first two Status menu items with the cursor on 1).

With the **Arrows** or number **6**, select 6)REMOTE PORT. Activate the selection with **Enter** or number **6**. The unit shows the following parameters (an asterisk indicates the presence of the parameter):

RX	Characters received at remote port
ID	Unit ID received at remote port
CRC	Correct CRC received
PC	Correct passcode received
TX	Characters transmitted from the remote port

CONFIGURATION (CONFIG)

The Configuration menu is used to set the TSU 600 operational configuration, including all network interface parameters and the allocation of the DS0s and the port parameters. See Figure 3-12.



Figure 3-12
Complete Configuration Menu

Menu flow is normally depicted from left to right. Arrows on the lower right of the screen indicate the direction of scrolling to use to view additional menu items. At every level of the menu pressing **Cancel** returns the system to the previous menu level. Pressing **Cancel** repeatedly returns the system to the Main menu.

Network (NI)

This menu item accesses the configuration of parameters associated with the network interface in the base unit. There are eight submenu items that include setting the format, the line build out (LBO), and the timing mode. Submenu items do not include setting the parameters which may be necessary for a secondary interface (DSX-1 Passthru, etc.).

Operation

Follow standard operating procedure to access the Network (NI) menu items.

With the cursor on 1)NETWORK (NI), activate the menu with **Enter** or number **1**. The unit displays the first two configuration submenu items. The **Down Arrow** indicates there are additional menu item selections available.

Continue with standard operating procedures to edit the network interface parameters.

Network (NI) Menu Items

The menu items are:

FORMAT

- Sets the frame format for the NI.
- Options: D4, ESF.



NOTE

D4 is equivalent to superframe format (SF).

CODE

- Sets the line code for the NI.
- Options: AMI, B8ZS.

YEL ALARM

- Enables and disables the transmitting of yellow alarms.
- Options: ENA, DISA.

XMIT PRM

- Enables and disables the sending of PRM data on the facility data link (FDL). The PRM data continues to be collected even if XMIT PRM is disabled (possible only with ESF Format).
- Options: Off, On.

CLOCK SOURCE

- Selects the clock source for transmission toward the network from the NI.
- Options: Network, Base DTE, Internal, and Secondary (SI).



NOTE

Base DTE and Internal are available only if no secondary interface is installed.

SET LBO

- Selects the line build out for the network interface. In AUTO mode, the TSU 600 sets the LBO based on the strength of the receive signal and displays the selected value.
- Options: 0.0 dB, 7.5 dB, 15 dB, 22 dB, Auto.

INBAND LPBCK

- Sets unit to accept or reject the in-band loop up and loop down codes as defined in ANSI T1.403. This is a line loopback.
- Options: Accept, Reject.

BIT STUFFING

- When enabled, bit stuffing causes the TSU 600 to monitor for ones (1s) density violations and insert a one (1) when needed to maintain ones at 12.5 %.
- Options: Enable, Disable.

Unit

The Unit menu is used to change the baud rate of the Control In port and the setup of the Dial Out port.

Operation

Follow standard operating procedure to access the Unit menu.

With the cursor on 2)UNIT, activate the menu with **Enter** or number **2**. The unit displays the first two submenu items.

Continue with standard operating procedure to select the baud rate, set modem flow control, set up the number used for alarm dial out, and exit the menu.

Unit Menu Items

The menu items are:

CTL PORT

- Sets the baud rate for communication with the PC or modem.
- Options: 1200, 2400, and 9600 kbps.

TRAPS

- Enables or disables the transmission of trap messages.

ACCESS

- Sets the method of connection from the TSU 100 to T-Watch/SNMP.
- Options:
 - Direct - Used if connected directly to the PC.
 - Dial - Used when connection is through a modem.The dial string is entered from T-Watch/SNMP.

Map Exchange (Map Xchng)

The Map Exchange menu is used to enable and set the automatic time of day map switch. The unit provides selection of the hour, minute, and seconds for the map switching to take place.

Operation

Follow standard operating procedure to access the Auto Map Changing menu item.

With the cursor on 3)MAP XCHNG, press **Enter**. The cursor moves to the select position over Auto or Off, whichever is displayed or currently active. See Figure 3-13.

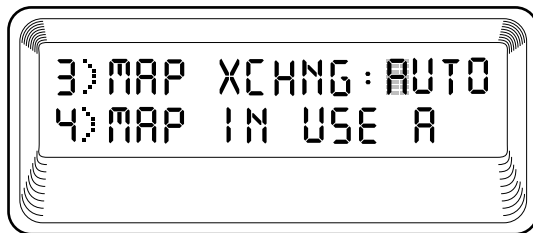

Figure 3-13
Map Exchange Selection Display

Map Exchange (Map Xchng) Menu items

The menu items are:

OFF

This indicates the map in use does not change (disabled).

AUTO

This indicates the system displays the screens to set times for switching (enabled).

Scroll to select Auto to enable or Off to disable the Automatic Map Change feature and press **Enter** to activate the selection.

When Auto is selected the unit displays the screens to set times for switching. See Figure 3-14.

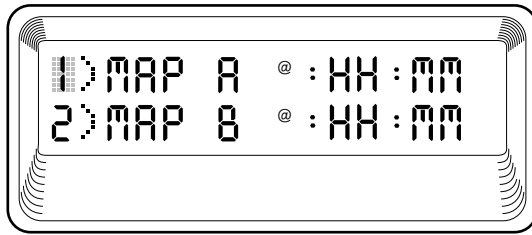

Figure 3-14

Selection Times for Map Exchange

With the cursor on 1)Map A, press **Enter** to activate the selection fields for hour, minute, and second. The cursor first moves to the hour position. Type in numbers and press **Enter**. The selected hour is entered and the cursor moves to the minute position. Set minutes by the same method as used to set the hours.

If a number is mistakenly entered, pressing **Cancel** interrupts the editing process. The procedure can be restarted to accept correct entries.

When using one digit numbers, the number appears in the first of two spaces. Upon pressing **Enter**, the system moves the single number to the second space and fills the first with a zero.

After editing Map A, press **Enter** to record the Map A settings and activate the selection fields for Map B. Use the same operation to edit switching time for Map B.

After settings for both Maps A and B are completed, press **Cancel** to return to 3)MAP XCHNG.

Continue with standard operating procedures.



NOTE

*When ESF is used with an FDL channel between units, the units automatically coordinate the automatic map switch by sending a map switch command from end-to-end over the FDL. Only one end needs to be set to **Auto** for this to work.*

Map In Use: A(B)

This menu item is used to control the DS0 map used by the TSU 600 and to display the map in current use.

Operation

Follow standard operating procedure to access the Map In Use menu item. Notice the current Map In Use is displayed. If no change is desired, proceed to another menu selection.

To manually change the Map In Use, place the cursor on the menu selection 4)MAP IN USE and press **Enter**. The cursor moves to the select position over A or B. Scroll to select A or B. This effects a manual change of the Map In Use from A to B or visa versa.

DS0 Map A and DS0 Map B

The DS0 maps designate which DS0s are assigned to which port. See Figure 3-15. There are three maps, DS0 Map A, DS0 Map B, and the Temporary (Temp) map.

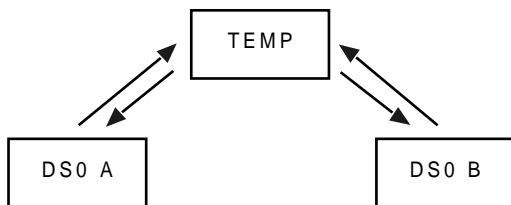

Figure 3-15
DS0 Map Designations

DS0 A and DS0 B are the current maps used by the TSU 600. The Temp map is used to generate a map before putting it into use.



NOTE

DS0 A can be copied to DS0 B by copying the DS0 A map into the TEMP map and then applying (writing) the TEMP into DS0 B.

Operation

The operation of DS0 Map A and Map B is identical. With the cursor on 5)DS0 MAP A, press Enter or number 5. The unit displays the first two DS0 Map A submenu items with the cursor on 1)COPY A> TEMP.

DS0 Map A and Map B Menu Items

The menu items are:

COPY A >TEMP

This copies the current map (A or B) into a TEMP map area. This permits modification without disturbing the existing map. When the modifications are completed the TEMP map is written to current MAP A (B) by selecting **Apply**.

CREATE TEMP

This creates a map by defining a port or Idle for all DS0s. Any or all of the DS0s can also be designated for Passthru if a secondary interface capable of Passthru is present. When 2)CREATE TEMP is selected, all DS0s are set to Idle, and those in use are set to the proper port.

A sample selection follows:

DS0: 01 to 24

PASSTHRU: Y for Yes

N for No

PORT: IDLE, TST, + option module ports



NOTE

TST is used to designate which DS0s are used for QRSS testing when activated under the 4)TEST Menu. When not used for testing, the TST designation is identical to IDLE.

With the cursor on 2)CREATE TEMP, press Enter. The unit displays the selection screen with the cursor positioned on the first selection DS0 number. See Figure 3-16.

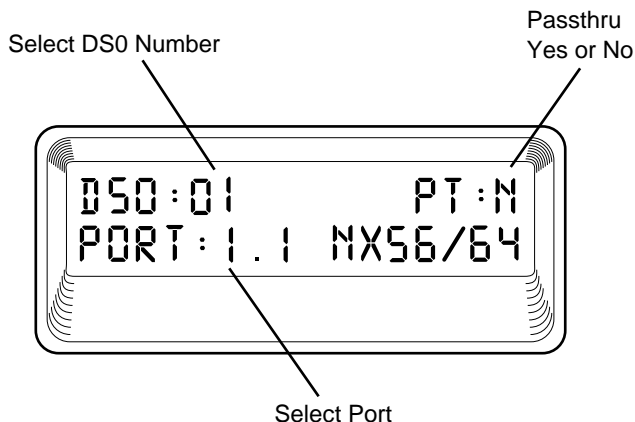

Figure 3-16
CREATE TEMP Selection Screen

Use either the scroll method or numbers to enter the DS0 number (do not mix the use of the keys). Pressing **Enter** completes the selection and moves the cursor to the next field, Passthru. Scroll to change, **Y** for Yes or **N** for No. Press **Enter** to complete the selection and move the cursor to the next field, PORT.

Scroll to select the port which is dependent on the installed option card. Press **Enter** to complete the selection and move the cursor to the next field, DS0.



*With the cursor on the DS0 field, the DS0 number can be incremented or decremented by scrolling. If **Copy** is pressed, the contents of the last DS0 entered are placed in the new DS0 number.*

When all entries are complete, **Cancel** moves the cursor to the last of the submenu choices, 6)APPLY. Either apply the newly created DS0 map or press **Cancel** to return to the DS0 Map A (B) submenu choices.

REVIEW MAP A(B)

Permits a quick review of the number of DS0s assigned to each port and the number of unassigned DS0s (Idle or TST) as defined in the currently applied Map A(B).

With the cursor on 3)REVIEW press Enter or number 3 to display the first of the assigned ports with the quantity of DS0s. See Figure 3-17. Use scroll to move through the displays.

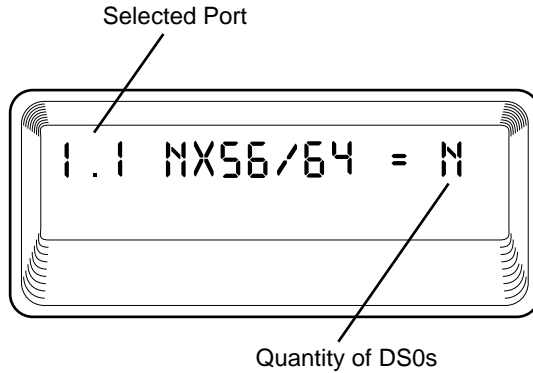

Figure 3-17
Selected Port and Quantity of DS0s

Continue with standard operation procedures to exit the menu.

REVIEW TEMP

This menu item is operated the same for the TEMP map as is 3)REVIEW MAP A or Map B.

EDIT TEMP

The map in the TEMP file can be edited to whatever configuration is desired. If Map A had been copied into the TEMP file, then after editing, the TEMP file could be applied to MAP A or MAP B.

With the cursor on 5)EDIT TEMP, press **Enter** to display the selection screen with the cursor on the first DS0 number. The menu displays are identical to 2)CREATE TEMP with the exception that the existing values (for Passthru and Port Select) are displayed.

Complete the editing of the scratch file the same as for 2)CREATE TEMP.

APPLY TEMP > A

Writes the TEMP map into Map A. Apply is usually the last step in updating a map and is accessed automatically at the end of editing or creating a temporary map. It can be bypassed at this time by selecting another menu choice.



*Selecting Apply does **not** disrupt normal data flow while the current map is overwritten with the new map. This will not cause a switch of the executing map; i.e., if Map A were modified while Map B was executing, selecting Apply will rewrite Map A but will not switch execution from Map B to Map A.*

Access 6)APPLY TEMP > A by following standard operating procedures or by completing a scratch map. Press **Enter** or number **6**. The unit displays DISRUPT DATA: YES or NO.

Scroll to select **Yes** or **No**.

- Yes** The display shows MAP APPLIED.
- No** The system returns to menu item
 6)APPLY.

When the desired selection is displayed, press **Enter** to activate the selection, followed by **Cancel** to return to menu operation.

PORT CONFIGURATION (PORT CONFIG)

Port Configuration is used to select and configure the parameters associated with any data port in the unit. For example, parameters for the DSX-1 (PBX) interface are set through this menu. The items that can be set depend on which option module is installed. The list of option ports will vary with the configuration.

The TSU 600 is designed so that any additional ports developed in the future will contain the appropriate menu selections to provide access by use of this menu item.



The Config menus for options ports are described in separate sections of the manual supplied with the option card.

Operation

Follow standard operating procedure to access 7)PORT CONFIG.

With the cursor on the number 7, press **Enter** or the number 7. Only the bottom line of the LCD changes to display 1.1 Nx56/64. The Nx56/64 interface located on the base is always present. See Figure 3-18.

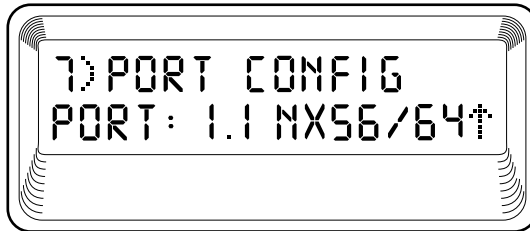

Figure 3-18
Port Configuration

Scroll to display the data port to be configured and press Enter to select. The unit displays the first of six submenu items for the Nx56/64.

UTILITY (UTIL)

The utility menu tree is used to view and to set system parameters (see Figure 3-19). This includes setting the time and date and resetting all parameters to factory values or to re-initiate the unit. This menu is also used to view the unit software revision and the unit ID setting.

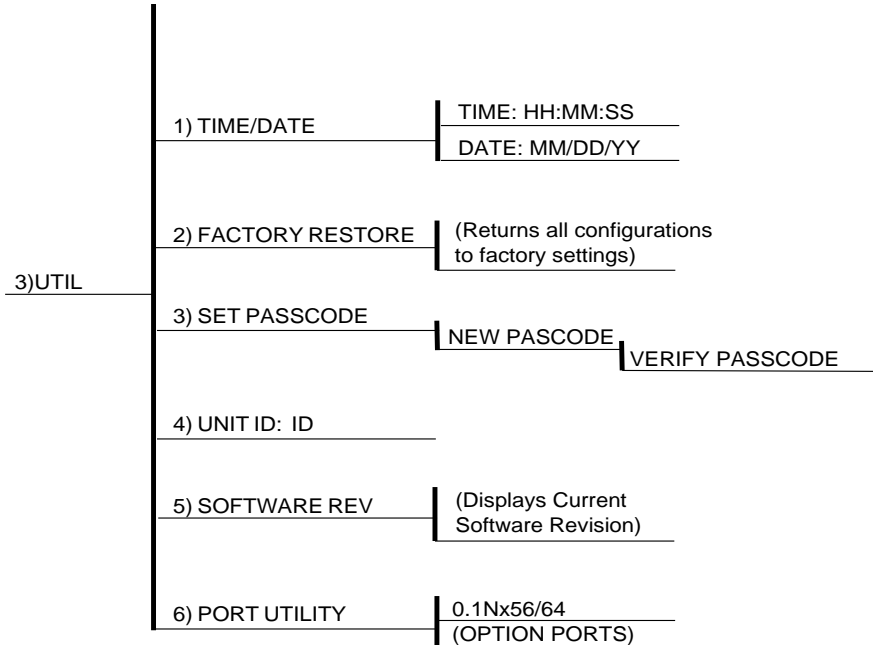

Figure 3-19
Complete Utility Menu Tree

Menu flow is normally depicted from left to right. Arrows on the lower right of the screen indicate the scrolling direction to view additional menu items. At every level of the menu, press **Cancel** to return the system to the previous menu level. Pressing **Cancel** repeatedly returns the system to the Main menu.

Time/Date

This menu option is used to view or to edit the current time and date. The time and date are maintained during power off conditions.

Operation

Follow standard operating procedure to access the 3)UTIL menu items.

With the cursor on 1)TIME/DATE, activate the menu with **Enter** or number **1**. The unit displays the current time and date with the cursor on the T in Time.

Use **Enter** to move to the first entry position and numbers to set the desired hour and minutes. Always use **Enter** to record the numbers and move to the next position. The **Up** and **Down Arrow** keys can also move the cursor to different fields to edit.

The Date is set using the same keystroke pattern used to set Time

To exit the TIME/DATE setting, press **Cancel**. The unit returns to the opening of TIME/DATE setting with the cursor on the 2 of 2)TIME/DATE. Any settings completed with an **Enter** keystroke have been recorded. Any settings not completed by an **Enter** keystroke are not recorded.

Summary for Editing Time/Date

Pressing **Enter** after any numeric change always records the entry and moves to the next editing position. Moving to a different field to edit is also possible by pressing **Enter** at the editing position without making any change, or by using the **Up** and **Down Arrow** keys. Pressing **Cancel** at any time can be used to end the editing process.

Factory Restore

This menu item is used to restore the factory default setting for all unit parameters. It will restore all parameters, including configured DS0 maps, to the factory settings. Factory defaults are listed in the appendix, *System Configuration Charts*.

Operation

Follow standard operating procedure to access the 3)UTIL menu items.

With the cursor on 3) FACTORY RESTORE, press **Enter**. The unit returns to the opening Main menu with all edited parameters and configurations deleted. All factory preset defaults are restored.

Set Passcode

Enter Passcode from Other Menus

The appearance of the Passcode prompt may make an unexpected appearance from other menu operations. This happens only when the unit is operating in the limited access mode, i.e., without an active passcode. The limited access mode may become active even if a passcode was entered as it does when there is no activity for ten minutes.

The unexpected appearance of the PASSCODE prompt occurs, for example, while operating in a limited access mode and attempting to change the Data Rate, (2)CONFIG, 2)UNIT, 1)CNTROL PORT, 1)DATA RATE. Use the number keys to enter the correct passcode and press **Enter**. The unit displays **Access Granted**.

Pressing any key after entering a passcode causes the unit to return to the previous active menu. In this case it returns to 2)CONFIG, 2)UNIT, 1)CNTRL PORT, 1)DATA RATE to permit changing the data rate.

Change/Set a Passcode

The passcode can be changed or set at any time or eliminated altogether through the Utility menu item 3)SET PASSCODE. This procedure requires the current passcode (if one is established) for operation.

Follow standard operating procedure to access the 3)UTIL menu items. With the cursor on 3)SET PASSCODE, activate the menu with Enter or number 3. The unit displays the prompt for the new passcode.

The passcode can only be entered by using numbers. After entering the desired passcode, press **Enter**.

Set a null passcode at the 3)SET PASSCODE menu by pressing Enter without any numbers. This sets a null passcode and grants unlimited access.

Unit ID: ID

This menu is used to access the current Unit ID setting. Viewing is available in limited access mode. Editing or changing the Unit ID requires the use of a password as in editing mode. Unit Identification numbers must be between 2 and 250. If an out of range number is entered, the unit assumes the upper limit number of 250.

Operation

Follow standard operating procedure to access the 3)UTIL menu items.

With the cursor on 5)UNIT ID, press **Enter** to display the Unit Identification number prompt.

Use **Enter** to active the menu and numbers to enter the unit number of three digits between 2 and 250.

Press **Enter** to complete the selection and return the cursor to 5)UNIT ID for another menu selection.

Software Revision (Software Rev)

This menu provides access to the display of the current software revision level loaded into the base unit controller. This information is required when requesting assistance from ADTRAN Customer Service or when updates are needed.

Operation

Follow standard operating procedure to access the 3)UTIL menu items.

With the cursor on 6)SOFTWARE REV, press **Enter** to display the current software revision level.

Use **Cancel** to exit.

PORT UTILITY

This menu provides access to the display of the current software information for each port installed in the unit. This information is required when requesting assistance from ADTRAN customer service or when updates are needed.

Operation

Follow standard operating procedure to access the 3)UTIL menu items.

With the cursor on 7)PORT, press **ENTER** to display the first available port.

Scroll through the available ports to display the desired port name. Press **ENTER** to access the displayed port name and the software version installed.

Use **CANCEL** to exit.

TEST

The Test menu is used to initiate different types of tests of the unit and to view test results. Test results are displayed in the LCD window. The Test menu contains four items (see Figure 3-20).



NOTE

The execution of tests will disrupt some of the normal operation. See individual menu items concerning tests before executing.

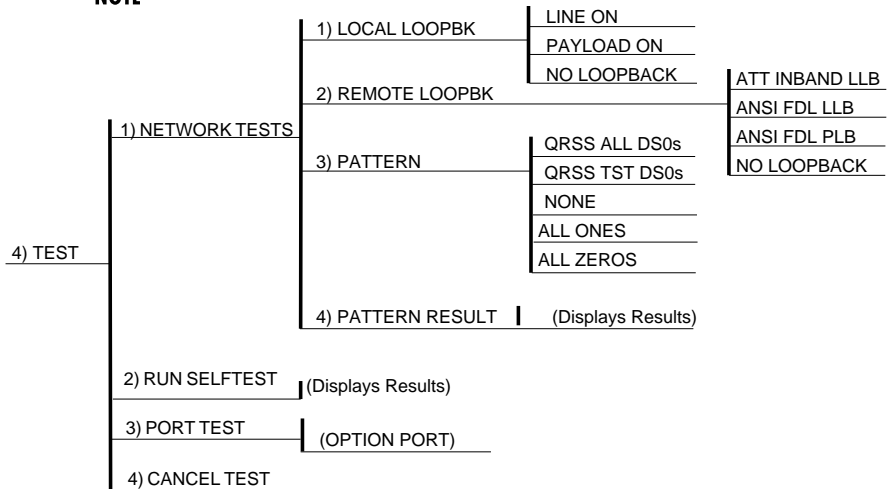

Figure 3-20
Complete Test Menu

Menu flow is normally depicted from left to right. Arrows on the lower right of the screen indicate the scrolling direction to view additional menu items. At every level of the menu pressing **Cancel** returns the system to the previous menu level. Pressing **Cancel** repeatedly returns the system to the Main menu.

Network Tests

Network tests are used to control the activation of loopbacks and the initiation of data test patterns. See Figure 3-5 for the list of tests.

Network tests are run on the Network Interface (NI). Three different test configurations can be selected to determine the type of loopback and the pattern to run. Test results are displayed in the LCD window.



NOTE

Operation

The execution of Network Tests will disrupt normal data flow unless only TST DS0s are selected for testing.

Follow standard operating procedures to access the Network Tests menu items.

With the cursor on Main menu item 4)TEST, press **Enter** or number **4**. The unit displays the first two Test submenu items with the cursor on 1)NETWORK TESTS. The **Down Arrow** indicates there are additional menu item selections available.

Press **Enter** to display the first of three submenu choices. The cursor is on 1)LOCAL LOOPBCK.

Network Tests Menu Items

The menu items are:

LOCAL LOOPBCK

There are three available choices for setting the local loopback:

- Line On** Activates the line loopback
- Payload On** Activates the payload loopback
- No Loopback** Deactivates the loopback

Scroll to select a setting and record it by pressing **Enter**. The unit returns the display of 1)LOCAL LOOPBCK and 2)REMOTE LOOPBCK

REMOTE LOOPBACK

This activates the same loopbacks as Local Loopback but at the far end. It uses either the inband loop-up code as specified by ANSI T1.403 for line loopback (ATT In-Band LLB), or the FDL as specified in ANSI T1.403 for payload and line loopback codes. The following options are available:

ATT In-Band LLB	Activates the line loopback using inband code
ANSI FDL PLB	Initiates the transmission of an FDL payload loop-up code toward the far end
ANSI FDL LLB	Initiates the transmission of an FDL line loop-up code toward the far end
No Loopback	Deactivates the loopback

**NOTE**

Remote Loopback cannot be used with Fractional T1 since the full T1 stream including the FDL is not transported to the far end.

After a Remote Loopback option is selected, the TSU 600 verifies that the far end is actually in a loopback by checking for the receipt of a code looped back from the far end. Once the Remote Loopback type is selected, the LCD displays the loopback progress by displaying **Looping** until loopback is verified.

PATTERN

This sets the pattern for the test and initiates the transmission of the pattern. The test is terminated by selecting **None**. The following patterns are available:

- QRSS All DS0s** Generates a QRSS test pattern and inserts the pattern into all DS0s
- QRSS TST DS0s** Inserts a QRSS pattern in those DS0s mapped as TST in the currently active map (A or B)
- None** Terminates pattern generation
- All ones** Inserts an all ones test pattern into all DS0s
- All zeros** Inserts an all zeros test pattern into all DS0s



QRSS always runs at 64K/DS0.

Use the up and down scroll to select, for example, QRSS ALL DS0. Press **Enter** to record the selection. The TSU 600 starts to generate a QRSS test pattern and inserts the pattern into all DS0s.

To end the test, select **None**.

PATTERN RESULT

Displays the results of the test currently active. See Figure 3-21. Leaving and returning to this menu item does not interrupt the test.



Code (version K or later): Pressing 2 injects errors into the test pattern. These errors are detected by the device performing the pattern check.

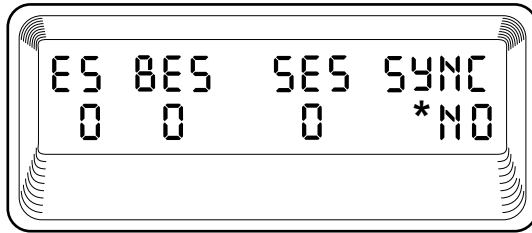

Figure 3-21
Test Pattern Results Display

ES	The number of seconds with at least 1 bit error.
BES	The number of seconds with more than 1 bit error and less than 320.
SES	The number of seconds with more than 320 bit errors.
SYNC	Indicates if pattern sync is, (yes) or is not, (no) valid. The asterisk () indicates if pattern sync has been lost since the start of testing.

Results can be cleared by pressing **Clear (shift 9)**.

The results are accumulated until the test pattern is set to **None** or **Cleared**.



NOTE

The use of TST DS0s for testing can be very useful, particularly in Fractional T1 applications. An end to end test can be run on the Fractional DS0s by 1) setting for Map B the TST in the same DS0 as used by Map A to receive data from an Nx56/64 port and 2) by looping the far end using a V.54 loopback code on the Nx56/64 port. In addition, a single DS0 can be used for continuous testing while other DS0s are passing normal data. This will also provide an end to end check on the entire link. Set each end to send QRSS in TST DS0s (using 1 DS0) and occasionally view the results on the Pattern Result menu selection.

Run Selftest

This menu selection is used to execute a full internal self test. The results of the self tests are displayed in the LCD. Upon invoking the command the LCD displays System Self-Test and the Test LEDs are illuminated. Test failures are displayed in the LCD window. The self test consists of the following steps:

1. Board level tests. Each of the TSU 600 boards contain an on board processor which executes a series of tests checking the circuitry on the board.
 - a. RAM tests; EPROM checksum
 - b. DSO map tests
 - c. On board data path; sending a known test pattern through an on board loop

2. Unit level tests.
 - a. Front panel LED verification
 - b. Phase Lock Loop verify
 - c. Board to board interface test
A test pattern is sent from the controller through a loopback on all other boards and checked on the controller. This verifies the data path, clocks, and control signals.

If a failure is detected, note the failure number prior to contacting ADTRAN Technical Support.



The execution of Self Test will disrupt normal data flow and prevent remote communication until the Self Test is completed.

Follow standard operating procedure to access the 4)TEST menu item.

With the cursor on 2)RUN SELFTEST, press **Enter** or number **2**. The unit runs through a changing display in the LCD showing the test outcome.

Press **Cancel** to exit.

Port Tests

The Port Tests menu is used to activate testing of specific data ports. It controls the activation of loopbacks and the initiation of data test patterns. Test results are displayed in the LCD window.



NOTE

Operation

The execution of Port Tests will disrupt normal data flow in the port being tested.

Follow standard operating procedure to access the 4)TEST menu item.

With the cursor on 3)PORT TESTS, press **Enter** or number **3**. The unit displays the available ports.

Select the port to activate tests and follow the Test menu of the option card.

Cancel Tests

Use this menu selection to deactivate all active tests, including tests on option modules.

Chapter 4

Example Operations

This chapter provides examples of how to configure the system for a variety of operations.

VOICE AND DATA MIX

The following is an example of the use of a TSU 600 to mix voice data from a PBX with data from a customer's DTE, possibly a LAN bridge (see Figure 4-1). This example assumes that B8ZS service is not available end to end and therefore must use 56K (672K rate) for the data and run AMI on the network. In addition, the format on the network is ESF while the PBX is D4.

The configuration charts shown here are filled in for the example. The appendix, *System Configuration Charts*, contains the same configuration charts with the selections not filled in.

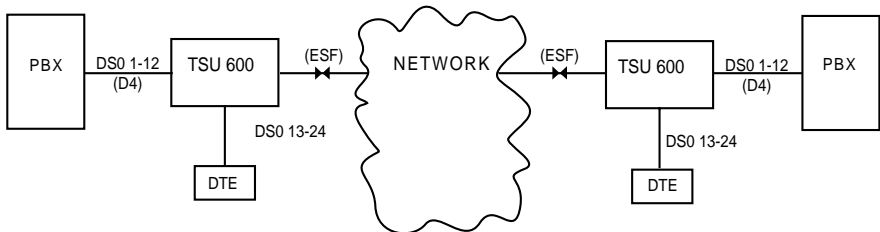

Figure 4-1
Example of Voice and Data Mix

STEPS TO SET UP VOICE AND DATA MIX

The five steps required to set up voice and data mix are presented in this section along with tables that provide examples of the required information.

Prior to Step 1

Complete the configuration chart. The configuration charts from the appendix, *System Configuration Charts*, can be copied and filled out to use as a reference or guide prior to actually setting any configuration.

Step 1. Configure the Network

Table 4-A provides configuration information for the network interface.

Table 4-A
Configuration for Network Interface

MENU ITEM	SELECTION USED	SELECTIONS AVAILABLE
1)FORMAT	ESF	D4, ESF
2)CODE	AMI	AMI, B8ZS
3)YEL ALARM	ENA	ENA, DIS
4)XMIT PRM	OFF	ON, OFF
5)TIMING MODE	NETWORK	NETWORK (NI), INTERNAL, DTE-BASE, NORMAL (CSU)
6)INBAND LOOPBK	ACCEPT	ACCEPT, REJECT
7)LINE BUILD OUT	0 dB	0 dB; -7.5 dB; -15 dB; -22 dB; AUTO
8)BIT STUFFING	DISABLE	DISABLE, ENABLE

Step 2. Configure DTE Port (1.1 - Nx56/64) (From Option Module)

Table 4-B provides configuration information for DTE ports.

Table 4-B
Configuration for DTE Port

MENU ITEM	SELECTION USED	SELECTIONS AVAILABLE
1)INTERFACE	V.35	V.35, RS530
2)RATE 56/64	56K	56K, 64K
3)TX CLK CNTRL	INTERNAL	INTERNAL, INTERNAL & INVERTED, EXTERNAL
4)DATA	NORM	NORMAL, INVERT
5)CTS	FORCED ON	NORMAL, FORCE ON
6)DCD	FORCED ON	NORMAL, FORCE ON
7)DSR	FORCED ON	NORMAL, FORCE ON
8)"O" INHIB	ON	ON, OFF

Step 3. Select the number of DS0s/Port: 12

The number of DS0s/Port is based on the Data Rate Table in the appendix, *Configure DTE Port*:

(1.1 - Nx56/64).

Step 4. Complete the DSO Map Configuration

Table 4-C provides information for configuring DSO maps.

Table 4-C
Configuration for DSO Map

DSO #	ASSIGN TO	PASSTHRU	DSO #	ASSIGN TO	PASSTHRU
1	6.1 DSX-1 PASTH	YES	13	1.1 Nx56/64	NO
2	6.1 DSX-1 PASTH	YES	14	1.1 Nx56/64	NO
3	6.1 DSX-1 PASTH	YES	15	1.1 Nx56/64	NO
4	6.1 DSX-1 PASTH	YES	16	1.1 Nx56/64	NO
5	6.1 DSX-1 PASTH	YES	17	1.1 Nx56/64	NO
6	6.1 DSX-1 PASTH	YES	18	1.1 Nx56/64	NO
7	6.1 DSX-1 PASTH	YES	19	1.1 Nx56/64	NO
8	6.1 DSX-1 PASTH	YES	20	1.1 Nx56/64	NO
9	6.1 DSX-1 PASTH	YES	21	1.1 Nx56/64	NO
10	6.1 DSX-1 PASTH	YES	22	1.1 Nx56/64	NO
11	6.1 DSX-1 PASTH	YES	23	1.1 Nx56/64	NO
12	6.1 DSX-1 PASTH	YES	24	1.1 Nx56/64	NO

Step 5. Complete a Configuration Table for the DSX-1 PBX Passthru

Table 4-D provides information for configuring the DSX-1 PBX passthrough.

Table 4-D
Configuration for DSX-1 PBX Passthru

MENU ITEM	SELECTION USED	SELECTIONS AVAILABLE
1)FORMAT	D4	D4, ESF
2)CODE	AMI	AMI, B8ZS
3)YEL ALARM	ENA	ENA, DIS
5)CLK SOURCE	XXX*	NETWORK (NI), TI(LOOP)
6)INBAND LOOPBK	ACCEPT	SET BY NI
7)LINE BUILD OUT	400Fl.	1-110: 110-220: 220-330: 330-440: 440-550: 550-655: >655

Step 6. Activate Configuration Menu

From the Main menu select the Configuration menu. The unit displays the first two Configuration submenu items: Network (NI) (network interface) and Unit (see Figure 4-2).

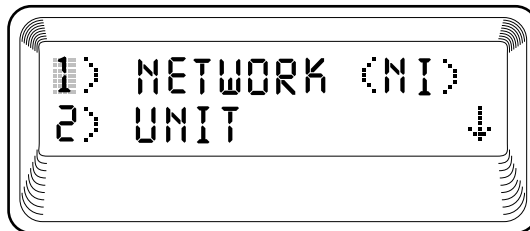

Figure 4-2
First Two Configuration Menu Items

CONFIGURING THE NETWORK INTERFACE

Place the cursor on 1)NETWORK (NI) with the number **1** or by scrolling. Activate the Network Interface Configuration menu with **Enter** or the number **1** again.

The unit displays the first two Network (NI) submenu items (see Figure 4-3).

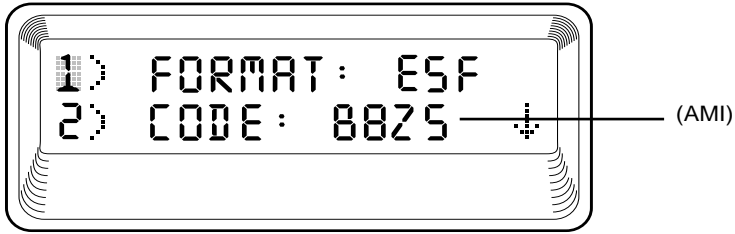

Figure 4-3
First Two Network (NI) Configuration Menu Items

The Code (Item 2) is incorrectly set. To make changes, scroll down or use number **2** to select the CODE menu item. Press **Enter** to move the cursor to the data field (B8ZS), to the right of 2)CODE.



NOTE

Pressing 2 again will not move the cursor into the data field. This helps prevent inadvertent activation of menu actions.

Scroll down to display AMI and press **Enter** to set the line code to AMI (changed from B8ZS). The cursor moves back to 2)CODE menu position.

Scroll to examine the other Network (NI) items.

Since no other items need to be changed, press **Cancel** to exit the Network(NI) submenu. The display returns to the first two Network (NI) submenu items (see Figure 4-4).

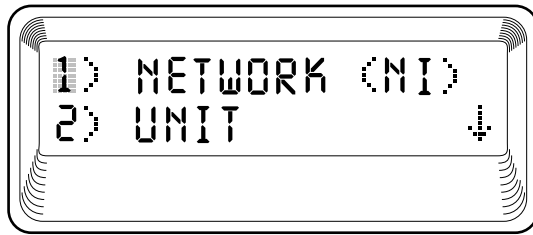

Figure 4-4
First Two Network (NI) Menu Items

CONFIGURING THE DSO MAP

From the first menu position scroll down or use number 5 to select the DSO MAP A configuration. Press number 5 again or **Enter** to enter the DSO MAP A Configuration menu (see Figure 4-5).

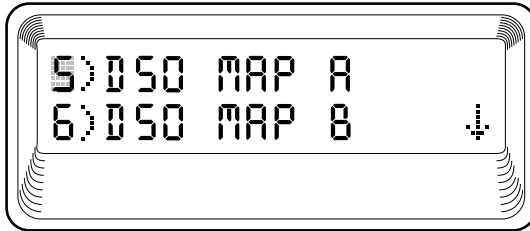

Figure 4-5
DSO Map A and Map B Configuration Menu Items

Scroll down or press number 2 to place the cursor on 2)CREATE TEMP menu item. Press **Enter** to activate the Create Map menu which opens a display from which a DSO number can be selected (see Figure 4-6).

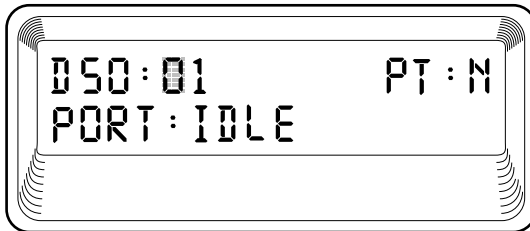

Figure 4-6
Create Map Menu with Displayed DSO Number

If the DSO number displayed is the desired number, press **Enter** to select it for an entry.

Display the correct numbers by entering numbers or by scrolling. Press **Enter** to record the displayed DSO for an entry and advance the cursor to the Passthru selection field.

According to the DS0 Map work sheet, Passthru for this DS0 should be set to **Y** for Yes (see Figure 4-7).

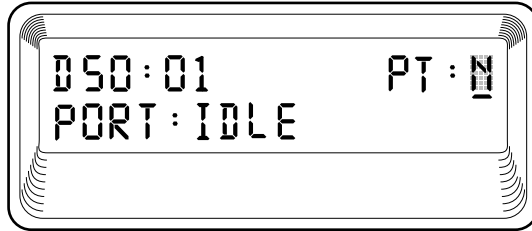

Figure 4-7
Passthru Selection Field

Scroll down to display the **Y** and press **Enter** to select. The cursor advances to the PORT selection field.



NOTE

If the Port is set to DSX-1 the TSU 600 will automatically set the Passthru (PT) bit to Y.

Scroll down to advance through the Port list until the 6.1 DSX-1 Port name is displayed (see Figure 4-8). Press **Enter** to select and move the cursor back to the DS0 # field.

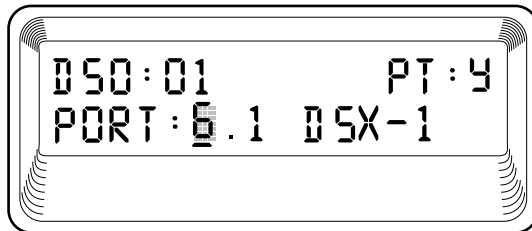

Figure 4-8
Display of DS0 Port Name

Another DS0 may be selected by incrementing the DS0 number using the **up arrow** key or, for this example, typing number **2**.



NOTE

*Since the data for this DS0 is identical to the previous DS0 just entered, it can be duplicated using **Copy**. The PT and PORT data fields are set to the same value as was last entered.*

This operation (changing the DS0 number and copying) can be repeated for DS0s 3 through 12 which, according to the configuration chart, are all identical.

At DS0 13 the data values changes can be set with the same operational procedures as used for DS0 #1. DS0 13 PT field is set for N and the PORT is 1.1 Nx56/64.

At DS0 14-24, the setting of the data is accomplished by using the same incrementing and copy technique.

When all DS0 settings are complete press **Cancel** to exit Create menu.

TEMPORARY MAP

The TSU 600 is now holding the newly created DS0 Map A in a file as a temporary map. It can be reviewed or edited through the DS0 Map A menu.

Review

To Review the Temporary file, follow standard operating procedures to access the first two submenu items of 5)DS0 MAP A (see Figure 4-9).

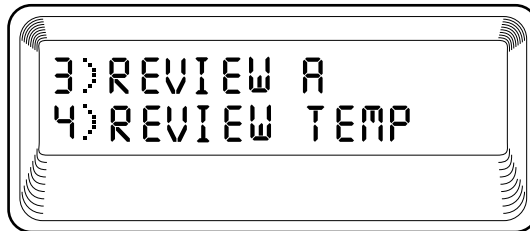

Figure 4-9

First Screen for Choosing to Review Temporary Files



NOTE

Throughout this review example, it is assumed that DS0 17 was inadvertently skipped.

Upon activating the 5)DS0 Map A menu, the fourth submenu item must be accessed. Select Review Temp by pressing number **4** or using the scroll to place the cursor on 4)REVIEW TEMP. Press **Enter** to activate the Review function. The unit begins the display with the number of DS0s set for Idle (see Figure 4-10).

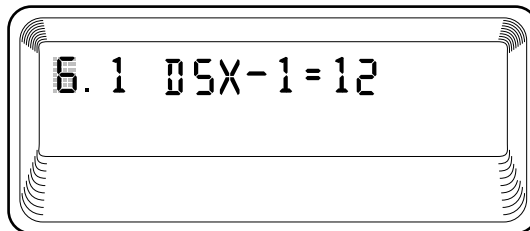

Figure 4-10
A Review Screen

Edit

The Review reflects that one of the DS0s is still programmed as Idle, and since the 1.1 Nx56/64 port has one less DS0, the error must be somewhere between DS0 13 and 24.

The map that was just created is still a Temp Map, and must be edited as such.

Return to the DS0 MAP A configuration items by using **Cancel**. Use number **5** or down scroll to move the cursor to 5)EDIT TEMP (see Figure 4-11). Press **Enter** to display the settings for DS0 #1 that have just been entered. The cursor is on the DS0 # field.

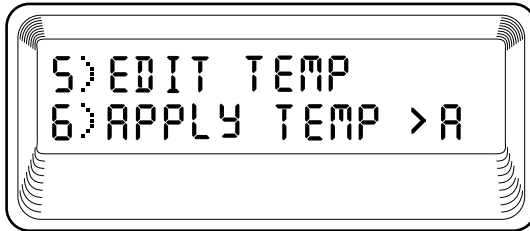
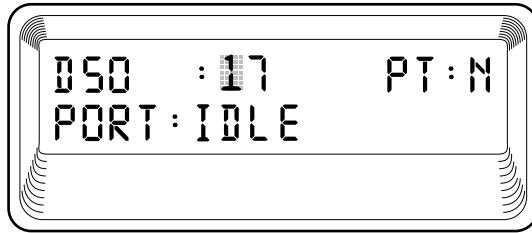

Figure 4-11
Window Showing Edit Temp Option

Since the error is between DS0 13 and 24, use number **1** and **3** to set the DS0 at number 13. Press **Enter** to display the contents of DS0 # 13.

Use up scroll to increment through the DS0s, reviewing each for accuracy. The display of DS0 17 will identify the error (see Figure 4-12).

**Figure 4-12***Window Showing the Error*

To correct the setting press **Enter** twice to advance the cursor to the Port data field. Use scrolling to display the correct Port and **Enter** to record the selection.

The Temporary Map can be reviewed as many times as necessary. When all corrections are completed use **Cancel** to exit the Edit Temp menu. The unit returns to the DS0 Map A submenu listing with the cursor on 6)APPLY TEMP >A. Press **Enter** to activate Apply.

**NOTE**

*Applying a map will **not** disrupt data flow.*

**NOTE**

The entire map can be cleared by first selecting CREATE, which has all DS0s set to PSTRU=N and PORT=IDLE, and then select APPLY to write the Idle map into the Current map.

Use **Cancel** to exit DS0 Map A and return to the Config submenu.

Configuring the Ports



Scroll down or use the number 7 to move the cursor to 7)PORT CONFIG. Press **Enter** to activate the Port Configuration menu item (see Figure 4-13).

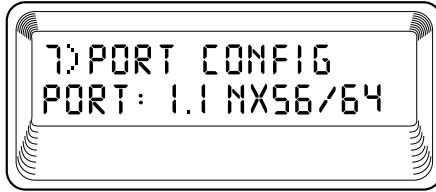

Figure 4-13

Window Showing Port Configuration Option

Press **Enter** to enter the Base Nx Configuration menu.

Using the same operational methods as before, select item 2)RATE to change from 64K mode to 56K mode (see Figure 4-14).

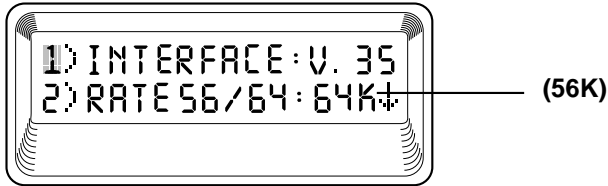

Figure 4-14

Screen Used To Change Mode

Scroll to continue viewing the remainder of the menu selections, comparing all the settings against the configuration chart.

Cancel returns to the PORT menu. Scroll to change the port designation to 6.1 DSX-1.

Enter the DSX-1 Configuration menu.

The TSU 600 is now completely configured and capable of passing data from the PBX and the DTE. Prior to actually using the configuration to pass voice and data, it is recommended that tests be run on the circuit.

TESTING EXAMPLE

If the example operations in the preceding pages were followed, the TSU 600 is completely configured and capable of passing data from the PBX and the DTE. Prior to actually using the configuration to pass voice and data, it is recommended to run tests on the circuit.

Testing consists of sending a test pattern from end to end and checking for errors in the pattern. There are two types of tests used to accomplish this.

- Send the pattern from one end and loopback the far end.
- Send the pattern from both ends and check at both ends.

Far End Looped Back Test

Two types of tests can be executed with the far end looped. The first is a check of the network and the network interfaces at both ends (QRSS). The second is a check of the DTE port.

Network Interface Test

The Network Interface Test can only be run when a full T1 is available (i.e., this cannot be used over Fractional T1).

At the Main menu place the cursor on 4)TEST with the number 4 or by scrolling. To activate the menu, again press number **4** or **Enter**.

The unit displays the first two Test submenu items with the cursor on 1)NETWORK TESTS (see Figure 4-15). To activate, press number **1** or **Enter**.

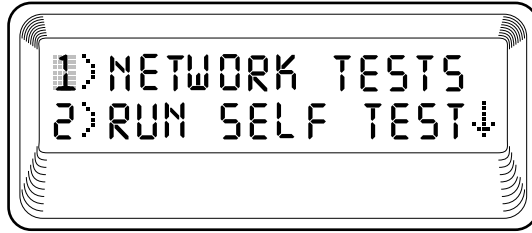

Figure 4-15
Test Menu One

The unit begins a display of the submenu items. The selections available for each of the four screens (see Figure 4-16) are selected by scrolling.

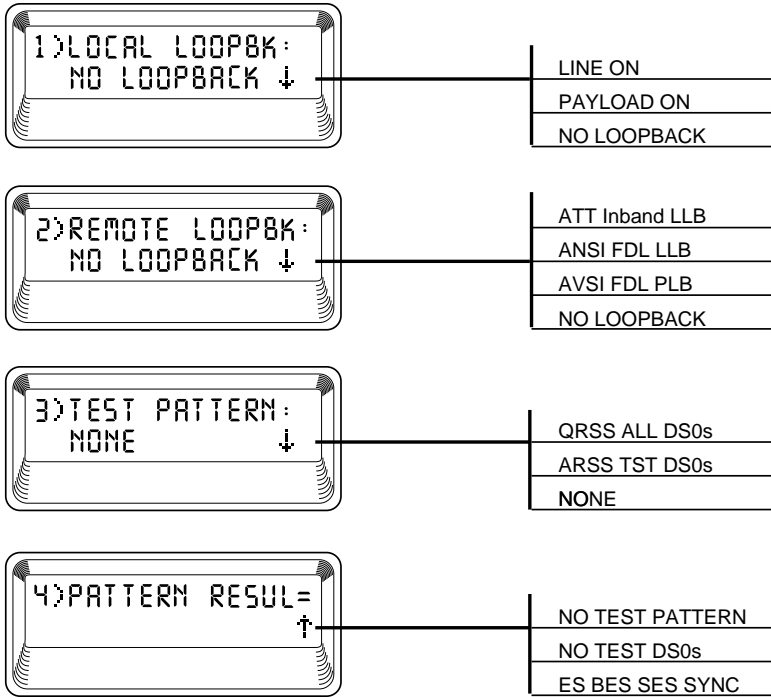

Figure 4-16
The Four Test Submenu Windows

With the cursor on 1)REMOTE LOOPBK, **Enter** activates the submenu. Scroll to select a setting for PAYLOAD in the data field. When selected, press **Enter** to activate.

This initiates the transmission of a loop-up code toward the far end (see Figure 4-17).

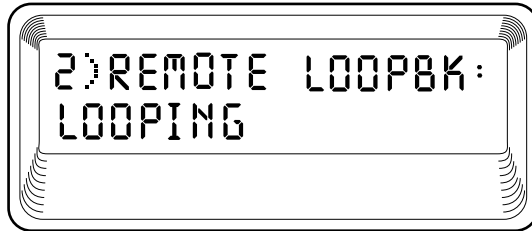

Figure 4-17

Screen that Appears During Loopback Verification

The TSU 600 verifies that the far end has gone into loopback by verifying the receipt of the code at the originating end. While waiting for loopback verification, the TSU displays **Looping**.

When completed, scroll or use number 3 to select 3)PATTERN. Use **Enter** key to activate the Pattern submenu. For Remote Loopback, scroll to select QRSS All DS0s and **Enter** to activate the selection (see Figure 4-18).



Figure 4-18

Test Pattern Screen for QRSS all DS0s

The TSU 600 begins to automatically check for synchronization and bit errors.

The results of this check are shown under submenu item 4)PATTERN RESULTS (see Figure 4-19).

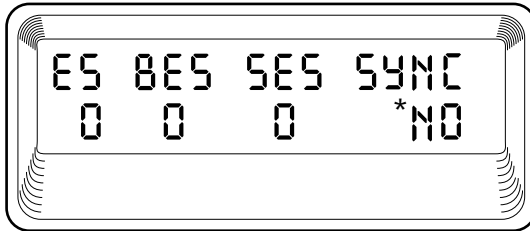

Figure 4-19
Test Pattern Results Display

The Test Pattern Results are explained in the following discussion :

- ES** The number of seconds with at least 1 bit error.
- BES** The number of seconds with more than 1 bit error and less than 320.
- SES** The number of seconds with more than 320 bit errors.
- *** The pattern sync has been lost.
- No (Yes)** Current pattern sync status. Indicates if pattern sync is **(Yes)**, or is not **(No)**, valid.



NOTE

Pressing the 2 key results in injecting errors.

Clear the results with the **Clear** key (shift 9).



NOTE

If not in pattern sync, the TSU does not accumulate errored seconds.

When through viewing the results, **Cancel** returns the unit to submenu item 3)TEST PATTERN. Select **None** to terminate the test and the QRSS pattern generation. The far end will still be in loopback until the network REMOTE LOOPBK is set to **None** under submenu item 2)REMOTE LOOPBK.

Test Termination

Select TEST PATTERN name and deactivate the remote loopback by selecting no loopback on the remote loopback menu number **2**.

Appendix A

TSU 600 Menu Tree

This appendix contains the complete menu tree for the TSU 600.

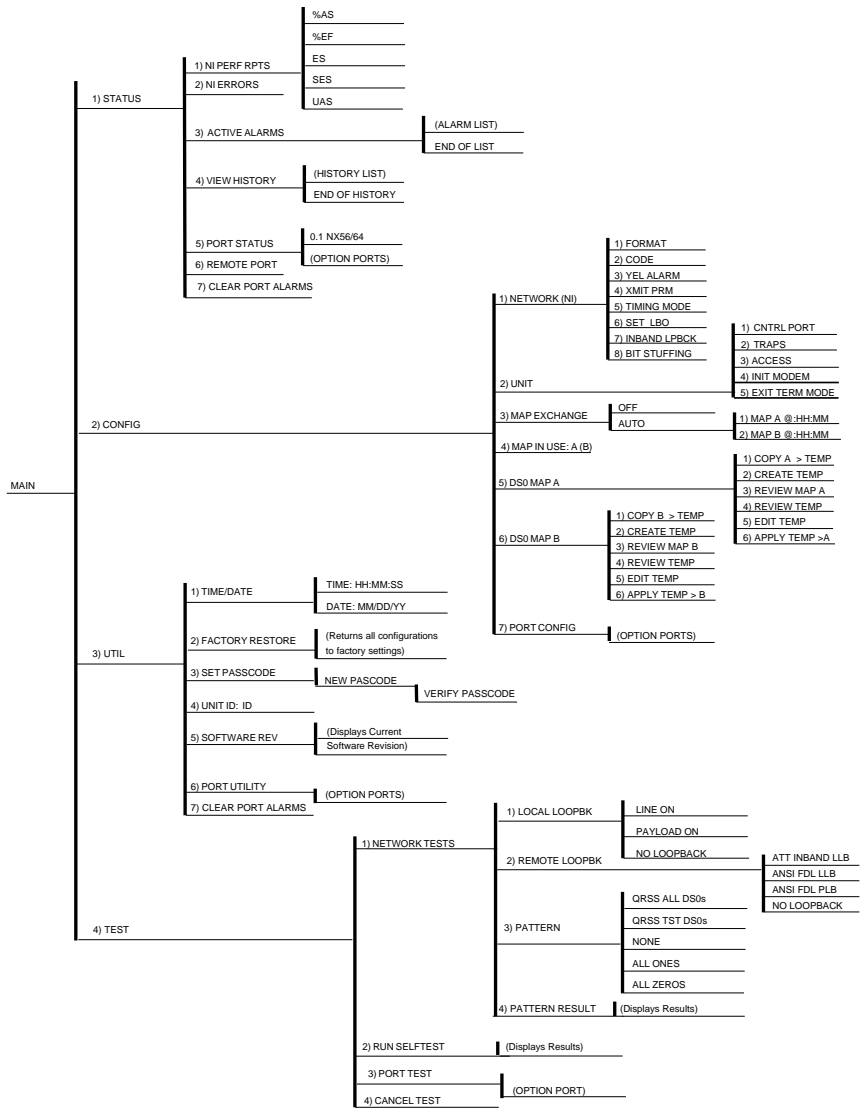

Figure A-1
TSU 600 Complete Menu Tree

Appendix B

DTE Data Rate Chart

This appendix contains the DTE data rate chart.

Table B-A
DTE Data Rate vs. DSOs

# OF DSOs (N)	DTE RATE=56K	DTE RATE=64K
N=1	56K	64K
N=2	112K	128K
N=3	168K	192K
N=4	224K	256K
N=5	280K	320K
N=6	336K	384K
N=7	392K	448K
N=8	448K	512K
N=9	504K	576K
N=10	560K	640K
N=11	616K	704K
N=12	672K	768K
N=13	728K	832K
N=14	784K	896K
N=15	840K	960K
N=16	896K	1024K
N=17	952K	1088K
N=18	1008K	1152K
N=19	1064K	1216K
N=20	1120K	1280K
N=21	1176K	1344K
N=22	1232K	1408K
N=23	1288K	1472K
N=24	1344K	1536K

Appendix C

System Configuration Charts

This appendix contains five steps/tables to support the chapter, *Example Operations*. It is recommended that these tables be copied and used as work sheets when configuring the system.

Step 1: Configure Network

Table C-A
Control Pin Connection Configuration Chart for Network Interface

MENU ITEM	SELECTION USED	SELECTIONS AVAILABLE
1)FORMAT		D4, ESF*
2)CODE		AMI, B8ZS*
3)YEL ALARM		ENABLE*, DISABLE
4)XMIT PRM		ON, OFF*
5)TIMING MODE		NETWK* (NI), INTERNAL, BASE DTE, SECONDARY INTERFACE, NORMAL
6)LINE BUILD		0dB*, 7.5dB, -15dB, -22.5dB, AUTO
7)INBAND LOOPBK		ACCEPT*, REJECT
8)BIT STUFFING		DISA*, ENA
* = Factory Default		

Step 2: Configure DTE PORT: (1.1 Nx56/64)

Table C-B
Configuration Chart for DTE Port

MENU ITEM	SELECTION USED	SELECTIONS AVAILABLE
1) INTERFACE		V.35*, RS530
2) RATE 56/64		56K, 64K*
3) TX CLK CNTRL		INTERNAL*, INTERNAL & INVERTED, EXTERNAL
4) DATA		NORMAL*, INVERT
5) CTS		NORMAL*, FORCE ON
6) DCD		NORMAL*, FORCE ON
7) DSR		NORMAL*, FORCE ON
8) "O" INHIB		ON, OFF*
* = Factory Default		

Step 3: Select number of DSOs/PORT _____

Based on Data Rate Table in the appendix, *DTE Data Rate Chart*.

Step 4: DSO Map A Configuration

Table C-C
DSO Map A Configuration

DSO #	ASSIGN TO	PASSTHRU?	DSO #	ASSIGN TO	PASSTHRU?
1			13		
2			14		
3			15		
4			16		
5			17		
6			18		
7			19		
8			20		
9			21		
10			22		
11			23		
12			24		

Step 5: DSO Map B Configuration

Table C-D
DSO Map B Configuration

DSO #	ASSIGN TO	PASSTHRU?	DSO #	ASSIGN TO	PASSTHRU?
1			13		
2			14		
3			15		
4			16		
5			17		
6			18		
7			19		
8			20		
9			21		
10			22		
11			23		
12			24		

Appendix D

TSU 600 System Messages

This appendix lists and defines the alarm and status messages that appear on the TSU screen.

ALARM MESSAGES: Network Interface (NI)

Red Alarm	NI unable to frame align with incoming signal
Yellow Alarm	Remote alarm indication (RAI) being received from far end
Blue Alarm being	Unframed all ones (1s) (AIS) received at NI
Loss of Signal	No signal detected at NI

STATUS MESSAGES: Network Interface (NI)

Payload On	Payload loopback activated
Line On	Loopback off
Loopback Off	All loopbacks deactivated
Factory Restore	Factory setting restored
Power On	Unit powered on
Self Test	Internal self-test performed

Index

Symbols

511 pattern 20

A

active alarms 55

ADTRAN PC program 9

alarm 41, 42, 56, 59

 active 48, 55

 history 56

 messages 55

arrows

 menus 43

automatic password time out 34

C

clear key 42

clock sources

 network 60

configuration (CONFIG) 49

 menu 58

configuration applications

 all voice 22

 bridge, PBX, video

 conferencing 21

 drop and insert, voice, and

 bridging 21, 23

 option modules 21

configuration menu

 configuration example 89, 91

 configuration menu diagram

 58

 detail 58

 overview 49

connectors

 pinouts 30

control source

 overview 9

 setup 36

 wiring 30

copy key 41

customer service 27, 75

D

data field 43

 display only 45

 exit 45

 set 44

 settings 44

DC powered units

display field 43

display panels

 CSU status 41

 LCD window 41

 module status 40

 remote 40

DS0 72

DS0 map
20, 33, 41, 49, 64, 65, 66, 81, 88,
92, 95, 96, 97
configuration example 85, 92
switch (Auto/Manual) 62

DTE
configuration example 85
Nx56/64 Configuration 69

E

example operations 85
exit menu operation 45

F

factory default 33, 36, 50
factory restore 72
far end loop back test 79, 100
fractional T1 2
front panel
6, 9, 17, 18, 19, 33, 35, 36, 39, 82
displays 40
keypad operation 39
layout 40
front view of TSU 600 3
functional description 3, 4

G

grounding instructions 28

I

initialization 38
self test 33
set control port 36
set unit identification number
35
set user passcode 34

interfaces, TSU 100 7
internal timing 13, 15
introduction 1

L

loopback 78
network 78
overview 17
T-Watch 17

loopback tests
DTE interface
DTE 18
port 19

M

menu
opening menus diagram 47
menu operation 73

N

network 7
network (NI)
configuration 58
example configuration 86, 90
NI errors 48
performance data 53
performance data clear 54
wiring 30

network interface 7

network tests
example 100
local loopback 78
pattern results 80
remote loopback 79

NI errors 48, 54
Nx56/64 configuration 69

O

operation 71, 72, 73, 74, 75
operation keys
A, B, C, D, E, F 42
alarm 42
cancel 42

- clear 42
- copy 41
- enter 42
- home 41
- keypad 42
- remote 41
- shift 42
- up and down arrows 42

P

- passcode 73
 - setting 34
- pattern generation
 - QRSS 80
- pattern generation and check 17
- performance report 9, 48, 53
- port configuration (Port Config)
 - 69
- port status 49, 56
- port utility 76
- power connection 26
- power up procedure 38

Q

- QRSS 7
- QRSS pattern 20, 80, 103

R

- rear panel
 - layout 5
- remote LED 40
- return material authorization 27
- review temporary map 66, 95

S

- secondary interface 6, 15, 59, 65
- secondary interface (SI) 12
- self test 6, 7, 17, 33, 41, 51, 82
 - board level tests 82

- unit level tests 82
- set passcode 73
- set time 71
- shift key 41, 42
- simple network management
 - protocol (SNMP) 9
- software rev 70, 75
- software revision 50
- status 48
- status menu
 - detail 52
 - overview 48
 - status menu diagram 52
- system configuration charts 72

T

- T-Watch
 - 9, 18, 19, 23, 24, 34, 39
- T-Watch management software
 - 24
- T1 service 1
 - T1, fractional 2
- T1/FT1 overview 1
- temporary map 65, 68, 95, 97
- test 51
 - cancel 83
 - menu 77
 - network 78
 - port 83
 - run selftest 82
- test menu 65, 77, 101
 - detail 77
 - overview 51
 - test menu diagram 77
- test patterns
 - 3 in 24 pattern 20
 - 511 pattern 20
 - QRSS pattern 20

testing

network

loopback tests 78

QRSS pattern 80

QRSS results 80

QRSS results cleared 81

overview 17

selecting TST DS0s 65, 80

self test 82

testing example 100

time 70, 71, 73

time/date 71

TSU 3

TSU 100 3

TSU 600 overview 3

TSU multiplexer 3

U

unit configuration 36

ctrl port 61

unit ID 35, 37, 70, 74

unit ID, setting 35

unit identification 74

utility (UTIL) 50

utility menu 38, 70

overview 50, 73

V

view history 49, 56

W

wiring 30

chain out 32

control in/chain in 31

network 30

PC control port 31

Product Support Information

Presales Inquiries and Applications Support

Please contact your local distributor, ADTRAN Applications Engineering, or ADTRAN Sales:

Applications Engineering (800) 615-1176
Sales (800) 827-0807

Post-Sale Support

Please contact your local distributor first. If your local distributor cannot help, please contact ADTRAN Technical Support and have the unit serial number available.

Technical Support (888) 4ADTRAN

Repair and Return

If ADTRAN Technical Support determines that a repair is needed, Technical Support will coordinate with the Return Material Authorization (RMA) department to issue an RMA number. For information regarding equipment currently in house or possible fees associated with repair, contact RMA directly at the following number:

RMA Department (205) 963-8722

Identify the RMA number clearly on the package (below address), and return to the following address:

ADTRAN, Inc.
RMA Department
901 Explorer Boulevard
Huntsville, Alabama 35806

RMA # _____