

TSU NetVanta Router Module

(with ADTRAN OS Command Line Interface)



Quick Start Guide

61202350L1-13A

June 2003

Before you begin...

Tools Required

- A VT100 terminal or a PC with VT100 emulator software for connecting to the unit.



The configuration sections of this quick start guide are formatted to provide both step-by-step text descriptions and screen shots containing a text script. The configuration scripts are available on the TSU NetVanta Router Module Documentation CD.

Specifications

Interface Type:

10/100 BaseT (RJ-48)

Configuration:

Mapping and testing functions performed through TSU/ESU front panel.

All router configuration performed through the **CONTROL** interface using ADTRAN OS Command Line Interface.

Environmental Specifications:

Operating Temperature: 0°C to 45°C

Storage Temperature: -20°C to 70°C

Relative Humidity: Up to 95% non-condensing

Compliance:

FCC Part 15, Class A

UL 60950, 3rd Edition

EN 60950

ETSI 300 386

Network Diagrams

Point-to-Point T1 Diagram (Use Steps 1-4, 6-12 to configure the PPP example and 1-5, 7-12 to configure the Frame Relay example.)

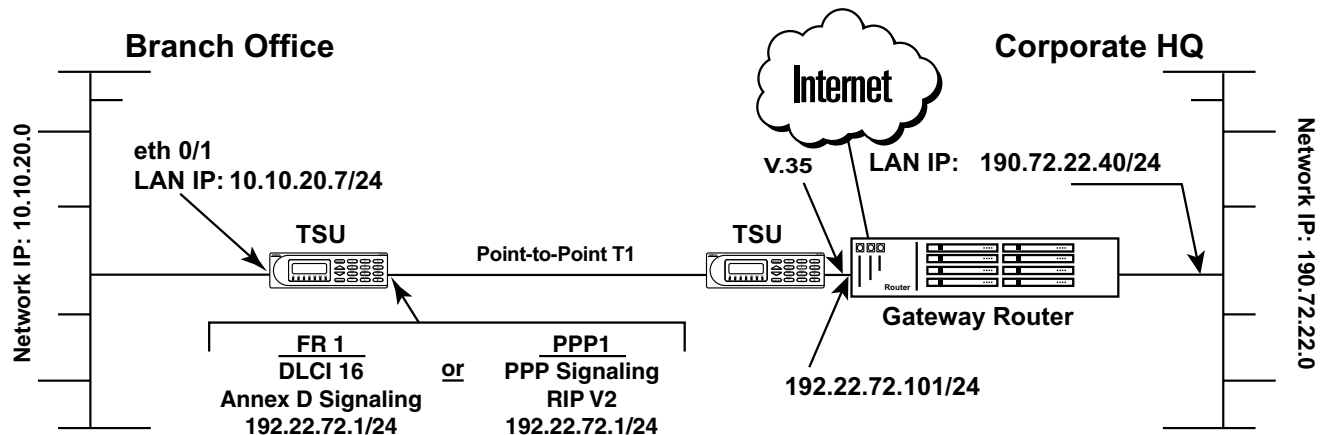

When designing a point-to-point application, ensure that there is timing on the circuit (by setting one unit to internal timing and one to network recovered timing). In addition, point-to-point frame relay applications require one device configured for USER signaling and one for NETWORK signaling.

1 Unpacking and Inspecting the System

Each TSU NetVanta Router Module is shipped in its own cardboard shipping carton. Open each carton carefully, and avoid deep penetration into the carton with sharp objects.

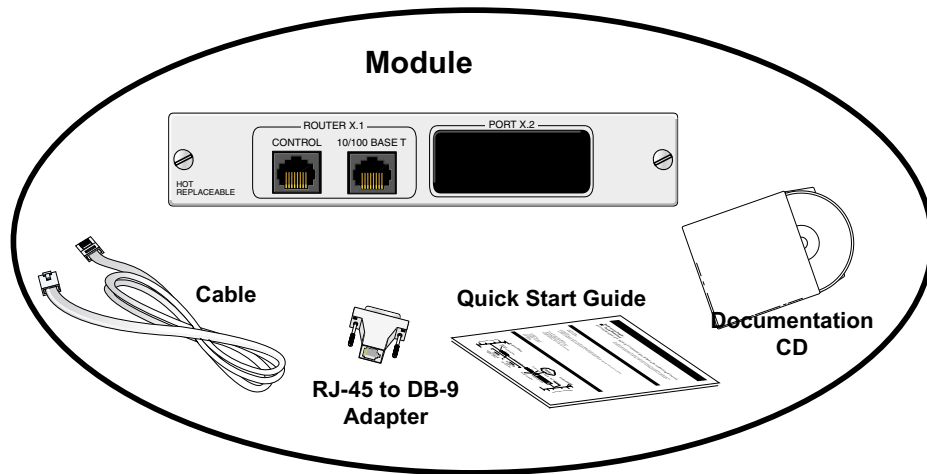

2 Reviewing the Module Design

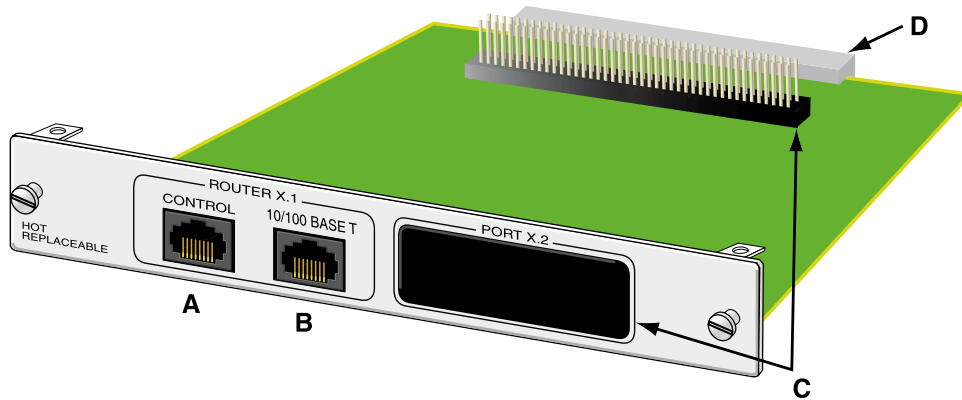

(A) CONTROL Interface

The **CONTROL** interface provides access to the ADTRAN OS Command Line Interface (CLI). A 6 foot data cable and an RJ-45 to DB-9 adapter (for connection to a standard PC COM port) are included in the TSU NetVanta Router Module shipment. Table 1 provides the pinout for the **CONTROL** interface. Refer to *Step 4a, Connecting to the Module (Control Port Connection)* for more details on using this interface.

Table 1: Control Interface Pinout

Pin #	Name	Description
1	GND	Ground
2	RTS	Request To Send — Input
3	TD	Transmit Data — Input
4	DSR	Data Set Ready — Output
5	RD	Receive Data — Output
6	CTS ^a	Clear To Send — Output
7	DTR	Data Transmit Ready — Input
8	DCD	Data Carrier Detect — Output

a. Used for hardware flow control

(B) 10/100 BaseT Interface

The TSU NetVanta Router Module provides a single RJ-45 10/100 BaseT interface for connecting to the local area network. Customers must supply the Ethernet cable for this connection. Table 2 provides the pinout for this interface. Connect on eth 0/1.

Table 2: 10/100 BaseT Interface Pinout

Pin #	Name	Description
1	TX1	Transmit Positive
2	TX2	Transmit Negative
3	RX1	Receive Positive
4, 5	UNUSED	—
6	RX2	Receive Negative
7, 8	UNUSED	—

The Router Module configuration is controlled by the ADTRAN OS Command Line Interface (CLI). This software is independent of the TSU/ESU firmware and must be accessed through the **CONTROL** interface (located on the front of the module). The ADTRAN OS references the **10/100 BASE T** interface as **eth 0/1**. Refer to *Step 4c, Configuring the Ethernet Port Parameters* for more details.

(C) Plug-On Module Interface

The TSU NetVanta Router Module is a plug-in module for all TSU and ESU modular multiplexers. The TSU/ESU product line offers a multitude of plug-on modules to further customize your network solution. The TSU NetVanta Router Module supports all TSU/ESU plug-on modules. Perform the following steps to install the plug-on board (see figure below):

1. Hold the plug-on board above the option module.
2. Using a downward and right-to-left motion, slip the plug-on module interface connector(s) (V.35 in the illustration below) into opening in the option module back panel.
3. Moving the plug-on board downward, secure the connection of the header pins at the front of the boards.

WARNING

The connection of the header pins between the option module and the plug-on board must be visually verified. Severe damage of the equipment can result from an improper connection.

4. Install the two 4-40 screws at both edges of the option module.

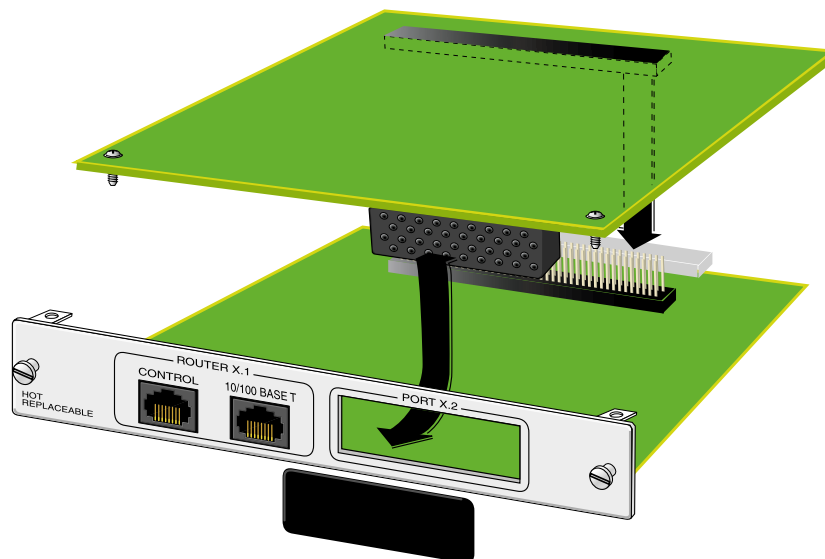

(D) Serial Connection to TSU/ESU Base Unit



The serial connection is the 64-pin connector (located on the rear of the module) used to connect the module to the TSU/ESU base unit backplane. This interface is always labeled **ser 1/1** by the ADTRAN Operating System (regardless of the slot in which the module is installed).

The TSU NetVanta Router Module provides a high speed serial interface for connecting to the TSU/ESU base unit. During configuration of the unit using the ADTRAN OS Command Line Interface, this interface is labeled **ser 1/1**. Refer to *Step 9, Activating the Serial Interface* for more details.

3

Mapping DS0s/TS0s Using the TSU/ESU Front Panel



The TSU NetVanta Router Module is labeled **X.1 ROUTER** from the TSU/ESU base unit front panel (where X is the number of the slot in which the module is installed)

T1 channels must be mapped from the T1/E1 Network interface to the TSU NetVanta Router Module using the TSU/ESU front panel. Follow the steps below to map channels 1-12 to the TSU NetVanta Router Module.

1. From the front panel select **2 CONFIGURATION** by pressing **2** then **ENTER**.
2. Identify the **MAP IN USE**. (By default, **MAP A** is the active map.)
3. Edit the active map by selecting either **DS0 MAP A** or **DS0 MAP B**.
4. Select **COPY A TO TEMP** to place a copy of the active map into temporary file storage.
5. Select **EDIT TEMP** to edit the copy of the active map.
6. Press **ENTER** to assign a port to DS0 1. Use the **UP** and **DOWN** arrows to select **X.1 ROUTER**; press **ENTER** to make the selection.
7. Press the * (**COPY**) key to copy this entry.
8. Press the **UP** arrow to display **DS0 2**. Press the * (**COPY**) key to map this DS0 to **X.1 ROUTER**. Repeat this step for DS0s 3-12.
9. Press **CANCEL** to return to the main **MAP A** menu.
10. Select **APPLY TEMP** to apply the new map to Map A.

4

Configuring the Router

The TSU NetVanta Router Module must be accessed and managed via the RJ-45 **CONTROL** port located on the front of the module. The default Ethernet port parameters allow the TSU NetVanta Router Module to be accessed using a hub and two Ethernet cables (one for the PC and one for the router). The default IP address is 10.10.10.1. Refer to *Step 10, Configuring Telnet* to configure the Telnet session.

4a

Connecting to the Module (Control Port Connection)

1. Connect a VT100 terminal (or PC with VT100 emulation software like HyperTerminal) to the TSU NetVanta Router Module **CONTROL** port using the provided 6 foot data cable and the RJ-45 to DB-9 adapter (for connecting to a standard communications port).
2. Configure the VT100 terminal (or COM port) with the following parameters:

Data Rate:	9600	Stop Bits:	1
Data Bits:	8	Flow Control:	None
Parity Bits:	None		
3. Open a VT100 terminal session. (Please refer to the appropriate VT100 terminal software documentation for detailed instructions.)
4. Press **<Enter>** to begin the configuration session. The ADTRAN OS CLI is now active.
5. The default password is **password** (all lowercase letters).



The configuration parameters used in the following examples are for instructional purposes only. Please replace all bold and underlined entries (**example**) with your specific parameters to configure your application.

4b

Setting the Enable Command Security Level Password (Optional)



For this example, replace the underlined word with a password of your choosing. Our example in Step 4c uses ADTRAN as the password.

1. Enter **enable** to enter the Enable command security level.
2. At the password prompt, type **password** (all lowercase).
3. Enter **config terminal** to enter the Global configuration mode.
4. Enter **enable password ADTRAN** to set an Enable level password of your choosing.



The Enable command security level passwords are case sensitive.

4c

Configuring the Ethernet Port Parameters

1. Enter **enable** to enter the Enable command security level.
2. Enter the password.
3. Enter **config terminal** to enter the Global configuration mode.
4. Enter **interface eth 0/1** to access the configuration parameters for the 10/100 BaseT port located on the faceplate of the module.
5. Enter **ip address 10.10.20.7 255.255.255.0** to assign an IP address to the Ethernet port using a 24-bit subnet mask.
6. Enter **no shutdown** to activate the interface to pass data.
7. Enter **exit** to exit the Ethernet interface commands and return to the Global configuration mode.

```
ethernet.txt - Notepad
File Edit Format View Help
! This is a sample script to configure the ethernet port.
! A text file version of this script (ethernet.txt) is available
! on the TSU NetVanta Router Module Documentation CD.
!
! First enter the Enable command security level.
enable
!
! We have defined an enable password of ADTRAN.
ADTRAN
!
! Next enter the global configuration mode.
config terminal
!
! Now, enter the ethernet interface configuration mode.
interface eth 0/1
!
! Assign the ethernet port an IP address.
ip address 10.10.20.7 255.255.255.0
!
! Activate the interface to pass data.
no shutdown
!
! Exit back to the global configuration mode.
exit
!
! End Script
```



The TSU NetVanta Router Module use a Slot/Port notation for interface identification.

4d

Configuring the Default Gateway



The following steps assume the Global configuration mode is currently active. Verify that the prompt of your module displays **(config)#**.

1. Enter **ip route 0.0.0.0 0.0.0.0 192.22.72.101** to add 192.22.72.101 to the route table as the default gateway.
2. If configuring the TSU NetVanta Router Module for Frame Relay applications, proceed to Step 5. If using the module in a PPP configuration, please skip to Step 6.

```
defgate.txt - Notepad
File Edit Format View Help
! This script configures the default gateway back to the host
! site router. A text version of this script (defgate.txt) is
! available on the TSU NetVanta Router Module
! Documentation CD.
!
! Enter the default gateway ip address to the route table.
ip route 0.0.0.0 0.0.0.0 192.22.72.101
!
! End script
```

5

Configuring the Frame Relay Virtual Interface

The following steps outline configuring a frame relay virtual interface (labeled 1) using a single DLCI back to the corporate router (defined as DLCI 16).



The following steps assume the Global configuration mode is currently active. Verify that the prompt of your module displays **(config)#**.

5a

Creating the Interface and Defining the Encapsulation

1. Enter **interface fr 1** to create a frame relay virtual interface labeled 1.
2. Enter **frame-relay lmi-type ansi** to configure frame relay virtual interface 1 to use ANSI (Annex D) signaling. The default LMI type is ANSI.
3. Enter **no shutdown** to activate the interface to pass data.
4. Enter **exit** to return to the Global configuration mode.

```
fr1.txt - Notepad
File Edit Format View Help
! This script creates a virtual frame relay interface labeled 1
! and defines ANSI (Annex D) as the signaling method. A
! text version of this script (fr1.txt) is available on the
! TSU NetVanta Router Module Documentation CD.
!
! First create the virtual frame relay interface and enter the
! configuration mode for the interface.
interface fr 1
!
! The prompt should now display Router(config-f1)#.
!
! Next assign the lmi type for the interface.
frame-relay lmi-type ansi
!
! Activate the interface to pass data.
no shutdown
!
! Exit back to the global configuration mode.
exit
!
! End script
```

5b**Creating the PVC and Assigning an IP Address**

1. Enter **interface fr 1.16** to create the first PVC assigned to frame relay virtual interface 1. This activates the configuration parameters for the PVC. Your prompt should now display **(config-fr 1.16)#**.
2. Enter **frame-relay interface-dlci 16** to assign DLCI 16 to this pvc.
3. Enter **ip address 192.22.72.1 255.255.255.0** to assign an IP address for this PVC using a 24-bit subnet mask.
4. Enter **exit** to return to the Global configuration mode.
5. If you are configuring the TSU NetVanta Router Module for use in a frame relay application and have completed Step 5, skip to Step 7.

```

pvc16.txt - Notepad
File Edit Format View Help
! This script creates a pvc assigned to frame relay virtual
! interface 1 using DLCI 16. A text version of this script
! (pvc16.txt) is available on the TSU NetVanta Router
! Module Documentation CD.
!
! First create the first pvc assigned to frame relay
! virtual interface 1.
interface fr 1.16
!
! Your prompt should now display Router(config-fr 1.16)#.
!
! Now assign DLCI 16 to the pvc.
frame-relay interface-dlci 16
!
! Next, assign an IP address to this pvc.
ip address 192.22.72.1 255.255.255.0
!
!
! Exit back to the global configuration mode.
exit
!
! End script

```



The default encapsulation is RFC1490 or IETF. Make sure the remote router uses the same encapsulation for frame relay.

6**Configuring the Virtual PPP Interface**

The following steps outline configuring a PPP virtual interface (labeled 1) to the remote router. If you are using frame relay, skip to Step 7.



*The following steps assume the Global configuration mode is currently active. Verify that the prompt of your module displays **(config)#**.*

6a**Creating the Interface**

1. Enter **interface ppp 1** to create a PPP virtual interface labeled 1.
2. Enter **no shutdown** to activate the interface to pass data.
3. Enter **exit** to return to the Global configuration mode.

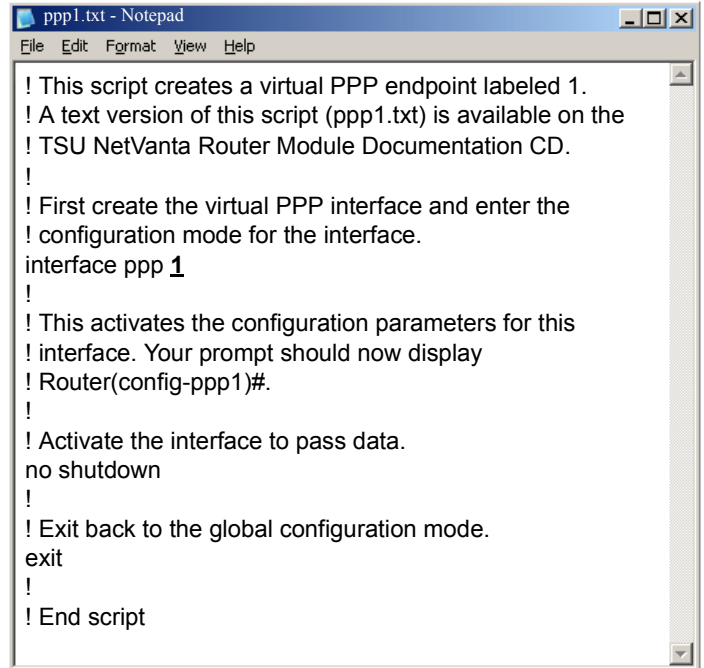

```
! This script creates a virtual PPP endpoint labeled 1.
! A text version of this script (ppp1.txt) is available on the
! TSU NetVanta Router Module Documentation CD.
!
! First create the virtual PPP interface and enter the
! configuration mode for the interface.
interface ppp 1
!
! This activates the configuration parameters for this
! interface. Your prompt should now display
! Router(config-ppp1)#.
!
! Activate the interface to pass data.
no shutdown
!
! Exit back to the global configuration mode.
exit
!
! End script
```

6b**Configuring the IP Parameters**

1. Enter **interface ppp 1** to activate the PPP interface configuration mode.
2. Enter **ip address 192.22.72.1 255.255.255.0** to assign an IP address to the PPP endpoint using a 24-bit subnet mask.
3. To activate the PPP interface, enter the **no shutdown** command.
4. Enter **exit** to return to the Global configuration mode.

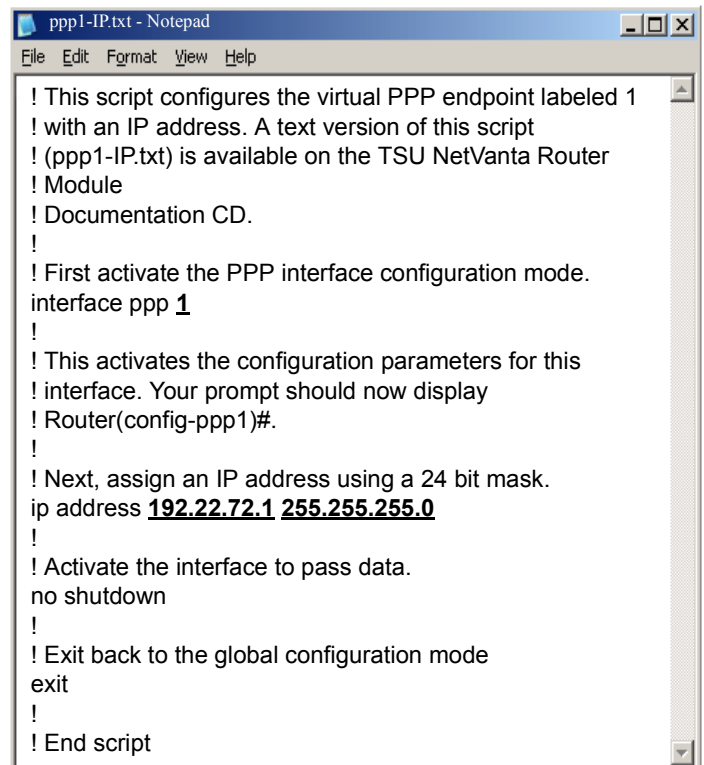

```
! This script configures the virtual PPP endpoint labeled 1
! with an IP address. A text version of this script
! (ppp1-IP.txt) is available on the TSU NetVanta Router
! Module
! Documentation CD.
!
! First activate the PPP interface configuration mode.
interface ppp 1
!
! This activates the configuration parameters for this
! interface. Your prompt should now display
! Router(config-ppp1)#.
!
! Next, assign an IP address using a 24 bit mask.
ip address 192.22.72.1 255.255.255.0
!
! Activate the interface to pass data.
no shutdown
!
! Exit back to the global configuration mode
exit
!
! End script
```

7

Creating the Cross-Connect



The following steps assume the Global configuration mode is currently active. Verify that the prompt of your module displays **(config)#**.

1. Enter **cross-connect 1 serial 1/1 frame-relay 1** to connect the serial connection between the router and the TSU/ESU base unit to the virtual frame-relay interface fr 1.16.

Alternately (for PPP),

1. Enter **cross-connect 1 serial 1/1 ppp 1** to connect the serial connection between the router and the TSU/ESU base unit to the virtual PPP interface labeled 1.

```

Cross.txt - Notepad
File Edit Format View Help

! This script creates a cross-connect to map the TDM
! group containing 10 DS0s on t1 1/1 to the virtual
! interface. A text version of this script (Cross.txt) is
! available on the TSU NetVanta Router Module
! Documentation CD.
!
cross-connect 1 serial 1/1 frame-relay 1
!
! Alternately, the cross-connect could be used to connect
! to the virtual PPP interface.
!
cross-connect 1 serial 1/1 ppp 1
!
! End script

```

8

Configuring RIP



The RIP configuration only applies to interfaces with IP addresses on the networks listed using the **network** command.

1. Enter **router rip** to activate the router configuration mode. Your prompt should now display **(config-rip)#**.
2. Enter **version 2** to globally define RIP version 2 on all interfaces.
3. Enter **network 192.22.72.0 255.255.255.0** to activate RIP on the virtual interface and **network 10.10.20.0 255.255.255.0** for the Ethernet interface (eth 0/1).
4. Enter **exit** to return to the Global configuration mode.

```

RIP.txt - Notepad
File Edit Format View Help

! This script configures the global RIP parameters for the
! router and adds the PPP 1 interface to the network list.
! A text version of this script (RIP.txt) is available on the
! TSU NetVanta Router Module Documentation CD.
!
! Activate the router configuration mode.
router rip
!
! Your prompt should now display Router(config-rip)#.
!
! Define the RIP version. This command sets the version
! for all interfaces using RIP.
version 2
!
! Add the interfaces using RIP to the network list.
network 192.22.72.0 255.255.255.0
network 10.10.20.0 255.255.255.0
!
! Exit back to the global configuration mode.
exit
!
! End script

```

Activating the Serial Interface



The following steps assume the Global configuration mode is currently active. Verify that the prompt of your module displays **(config) #**.

1. Enter **interface serial 1/1** to access the configuration parameters for the serial connection between the TSU NetVanta Router Module and the TSU/ESU base unit.
2. Enter **no shutdown** to activate the interface to pass data.
3. Enter **exit** to exit the serial interface commands and return to the Global Configuration mode.

```

activateser.txt - Notepad
File Edit Format View Help
! This is a sample script to activate the serial interface to
! pass data. A text file version of this script (activateser.txt)
! is available on the TSU NetVanta Router Module
! Documentation CD.
!
! Enter the serial interface configuration mode.
interface ser 1/1
!
! Activate the interface to pass data.
no shutdown
!
! Exit back to the global configuration mode.
Exit
!
! End script
  
```

Configuring Telnet

The default password for initializing a Telnet session is **password** (all lower case). For security purposes, the password should be changed to something unique. The following steps show how to access the Telnet configuration parameters and change the password. The password used in this example is **adtranuser**. Please replace this word with a unique password of your choosing.



To configure more than one Telnet session, repeat Steps 2 and 3 using incrementing labels. The TSU NetVanta Router Module supports five Telnet sessions.

1. Verify that the prompt of your module displays **(config)#**.
2. Enter **line telnet 0** to change the configuration parameters for the Telnet session (such as setting the line timeout, login requirements, password, etc.).
3. Enter **password adtranuser** to change the login password for the Telnet session. (See Note below.)
4. Enter **exit** to return to the Global configuration mode.

```

Telnet.txt - Notepad
File Edit Format View Help
! This script configures the login password for all
! telnet sessions to the router. A text version of this
! script (telnet.txt) is available on the TSU NetVanta Router
! Module
! Documentation CD.
!
! Change the configuration parameters for the telnet
! sessions.
line telnet 0
!
! Set the login password.
password adtranuser
!
! Exit back to the global configuration mode.
! End script
  
```

11 Saving the Configuration

1. Verify that the prompt of your module displays **(config)#**.
2. Enter **exit** to close the configuration session.
3. Enter **copy running-config startup-config** to save the current configuration to memory.
4. Enter **exit** to close the session.

12 Complete the Installation

The TSU NetVanta Router Module is now configured and operational. Complete the installation by connecting the appropriate cables to the Ethernet network. Refer to *Step 2, Reviewing the Module Design* for more details on pinouts and cabling.

13 Testing Options



The execution of Port Tests disrupts normal data flow to the port under test.

The TSU NetVanta Router Module provides several test features (through the TSU/ESU front panel only) for testing the connection between the module and the base unit (the serial interface).

Port/Local Loopback with Test Pattern

The TSU NetVanta Router Module port loopback activates both a local loopback (back towards the TSU NetVanta Router Module) and a port loopback (towards the TSU/ESU base unit) when evoked (see figure below). Using this loopback verifies the connection between the TSU NetVanta Router Module and the TSU/ESU base unit.

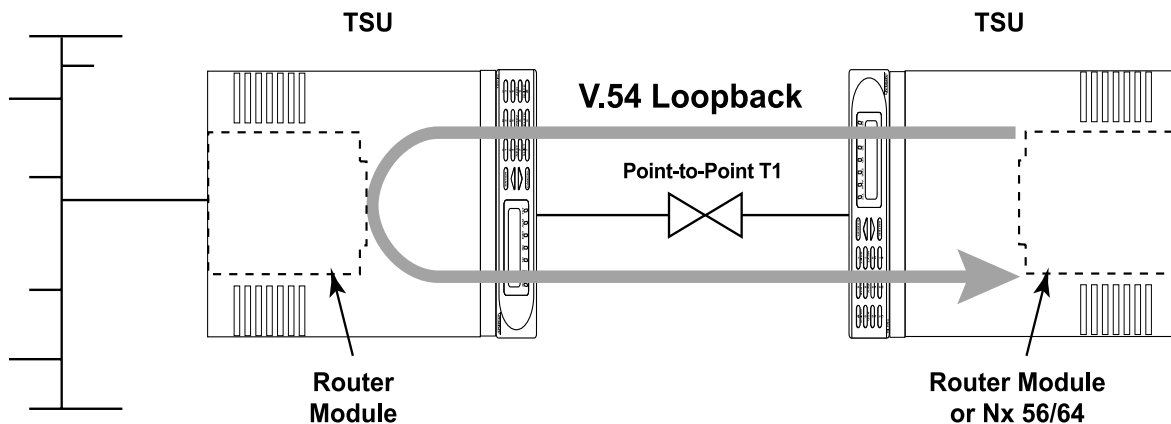

The following steps initiate a remote loopback of the Router Module "serial" interface:

1. From the remote TSU front panel select **4 TEST** by pressing **4** then **ENTER**.
2. Enter the **PORT TEST** menu by pressing **3** then **ENTER**.



You must enter your valid passcode to proceed with the rest of the test.

3. Select the **Nx/DBU** or **ROUTER** port to enter the tests mode.
4. Select **1 DTE LOOPBACK** by pressing **1** then **ENTER**. Use the up and down arrows to choose **REMOTE LOOPBACK** (or **REM V.54CONT** for the TSU NetVanta Router Module).



*Status messages display during the loop process. **FAR END LOOPED** displays when the remote loopback is successful.*

5. Select **2 511 PATTRN** to active the 511 pattern generator.
6. Select **3 511 PATT RESULTS** to view the test statistics.

Additional Information

For more information on the ADTRAN OS Command Line Interface, refer to the ADTRAN OS Command Line Interface Reference guide provided on the TSU NetVanta Router Module Documentation CD.