



## NetVanta 4300/4400 Series Hardware Installation Guide

1202890E1	NetVanta 4305 Chassis (AC)
1200950G1	NetVanta 4305 Chassis (DC)
1700630E1	NetVanta 4430 Chassis
4200368L1	Enhanced Feature Pack (Hardware and Software) for IPsec VPN Upgrade (NetVanta 4305)
1950730G2	Enhanced Feature Pack Software for IPsec VPN Upgrade (NetVanta 4430)
1200861L1	NetVanta 56K/64K Network Interface Module
1200862L2#NEBS	NetVanta T1/FT1 NEBS Network Interface Module
1202862L1	NetVanta T1/FT1 Network Interface Module
1202863L1	NetVanta T1/FT1 + DSX-1 Network Interface Module
1200872L1/1202872L1	NetVanta Dual T1 Network Interface Module
1202843E1	NetVanta Octal T1/E1 Wide Module
1200868E1/L1	NetVanta E1/FE1 Network Interface Module
1200878E1/L1	NetVanta E1/FE1 + G.703 Drop Network Interface Module
1200866E1	NetVanta Serial Network Interface Module
1200936E1	NetVanta SHDSL Network Interface Module, Annex A
1200937E1	NetVanta SHDSL Network Interface Module, Annex B
1202869E1	NetVanta ADSL Network Interface Module, Annex A
1202889E1	NetVanta ADSL Network Interface Module, Annex B
1702803F1	NetVanta USB WWAN Network Interface Module (NetVanta 4430 only)
1200864L1	NetVanta Analog Modem Dial Backup Interface Module
1200865L1	NetVanta ISDN BRI Dial Backup Interface Module
1200875L1	NetVanta ISDN S/T Dial Backup Interface Module
1200813E1/1200814E1	SODIMM, 256/512 MB (NetVanta 4430)

## Trademarks

Any brand names and product names included in this manual are trademarks, registered trademarks, or trade names of their respective holders.

## To the Holder of the Manual

The contents of this manual are current as of the date of publication. ADTRAN reserves the right to change the contents without prior notice.

In no event will ADTRAN be liable for any special, incidental, or consequential damages or for commercial losses even if ADTRAN has been advised thereof as a result of issue of this publication.

## Software Licensing Agreement

Each ADTRAN product contains a single license for ADTRAN-supplied software. Pursuant to the Licensing Agreement, you may: (a) use the software on the purchased ADTRAN device only and (b) keep a copy of the software for backup purposes. This Agreement covers all software installed on the system, as well as any software available on the ADTRAN website. In addition, certain ADTRAN systems may contain additional conditions for obtaining software upgrades.



*Changes or modifications to this unit not expressly approved by the party responsible for compliance could void the user's authority to operate the equipment.*

# ADTRAN®

901 Explorer Boulevard  
P.O. Box 140000  
Huntsville, AL 35814-4000  
Phone: (256) 963-8000

Copyright © 2019 ADTRAN, Inc.  
All Rights Reserved.  
Printed in U.S.A.

## Conventions

**NOTE**

*Notes provide additional useful information.*

**CAUTION**

*Cautions signify information that could prevent service interruption or damage to equipment.*

**WARNING**

*Warnings provide information that could prevent injury or endangerment to human life.*

## Safety Instructions

When using your telephone equipment, please follow these basic safety precautions to reduce the risk of fire, electrical shock, or personal injury:

1. Do not use this product near water, such as a bathtub, wash bowl, kitchen sink, laundry tub, in a wet basement, or near a swimming pool.
2. Avoid using a telephone (other than a cordless type) during an electrical storm. There is a remote risk of shock from lightning.
3. Do not use the telephone to report a gas leak in the vicinity of the leak.
4. Use only the power cord, power supply, and batteries indicated in the manual. Do not dispose of batteries in a fire. They may explode. Check with local codes for special disposal instructions.
5. The socket-outlet shall be installed near the equipment and shall be easily accessible.

If any of the following conditions occur, unplug the product from the electrical outlet and replace the part or contact your qualified service personnel:

1. The power cable, extension cable, or plug is damaged.
2. An object has fallen into the product.
3. The product has been exposed to water.
4. The product has been dropped or damaged.
5. The product does not operate correctly when you follow the operating instructions.



*These units contain no user-serviceable parts. They should only be serviced by qualified service personnel.*



*This equipment incorporates double pole/neutral fusing. If the neutral fuse opens and line fuse does not open, voltage could still be present in the unit.*



*Additional safety guidelines, such as Waste Electrical and Electronic Equipment (WEEE), are given in the document [NetVanta Safety and Regulatory Information](https://supportforums.adtran.com) available at <https://supportforums.adtran.com>.*

**Save These Important Safety Instructions**

### FCC-Required Information

**FCC regulations require that the following information be provided in this manual:**

1. This equipment complies with Part 68 of Federal Communications Commission (FCC) rules and requirements adopted by America’s Carriers Telecommunications Association (ACTA). Each registered interface has a label that contains, among other information, a product identifier in the format US:AAAEQ##TXXXX. If requested, provide this information to the telephone company.
2. If this equipment causes harm to the telephone network, the telephone company may temporarily discontinue service. If possible, advance notification is given; otherwise, notification is given as soon as possible. The telephone company will advise the customer of the right to file a complaint with the FCC.
3. The telephone company may make changes in its facilities, equipment, operations, or procedures that could affect the proper operation of this equipment. Advance notification and the opportunity to maintain uninterrupted service are given.
4. If experiencing difficulty with this equipment, please contact ADTRAN for repair and warranty information. The telephone company may require this equipment to be disconnected from the network until the problem is corrected, or it is certain the equipment is not malfunctioning.
5. This unit contains no user-serviceable parts.
6. This equipment is designed to connect to the telephone network or premises wiring using an FCC-compatible modular jack, which is compliant with Part 68 and requirements adopted by ACTA.
7. The following information may be required when applying to the local telephone company for leased line facilities:

Part Number	Registration Number	Service Type	REN/SOC	FIC	USOC
1200861L1	US: HDCDENAN1200861L1	56 kbps Digital Interface 64 kbps Digital Interface	6.0F	04DU5-56 04DU5-64	RJ-48S
1202843E1	US: HDCDENAN1202843L1	1.544 Mbps - SF 1.544 Mbps - SF and B8ZS 1.544 Mbps - ESF 1.544 Mbps - ESF and B8ZS	6.0N	04DU9-BN 04DU9-DN 04DU9-1KN 04DU9-1SN	RJ-48C
1202862L1	US: HDCDENAN1202863L1				
1202863L1					
1200872L1	US: HDCDENAN1200872L1				
1200864L1	US: HDCMM04A1200864L1	Analog Loop Start	0.4A/9.0Y	02LS2	RJ-11C
1200865L1	US: HDCDENAN1200865L1	Basic Rate ISDN	6.0F	02IS5	RJ-49C
1200869L1	US: HDCDL01A1200869L1	ADSL, ADSL2, ADSL2+ Modem	0.1A	Metallic	RJ-11C

8. The ringer equivalency number (REN) is useful in determining the quantity of devices you may connect to your telephone line and still have all of those devices ring when your number is called. In most areas, the sum of the RENs of all devices should not exceed five. To be certain of the number of devices you may connect to your line as determined by the REN, call your telephone company to determine the maximum REN for your calling area.
9. This equipment may not be used on coin service provided by the telephone company. Connection to party lines is subject to state tariffs. Contact your state public utility commission or corporation commission for information.

## FCC Radio Frequency Interference Statement

This equipment has been tested and found to comply with the limits for a Class A digital device, pursuant to Part 15 of the FCC rules. These limits are designed to provide reasonable protection against harmful interference when the equipment is operated in a commercial environment. This equipment generates, uses, and can radiate radio frequency energy and, if not installed and used in accordance with the instruction manual, may cause harmful interference to radio frequencies. Operation of this equipment in a residential area is likely to cause harmful interference in which case the user will be required to correct the interference at his own expense.

## Electromagnetic Compatibility (EMC) Table

NetVanta Module P/N and Name		NetVanta 4305 AC (1202890E1) and NetVanta 4305 DC (1200950L1)	NetVanta 4430 (1700630G1)
1200861L1	56K/64K NIM	FCC Part 15 Class A EN 55022 Class A	FCC Part 15 Class A EN 55022 Class A
1202862L1	T1/FT1 NIM	FCC Part 15 Class A EN 55022 Class A	FCC Part 15 Class A EN 55022 Class A
1202863L1	T1/FT1 + DSX-1 NIM	FCC Part 15 Class A EN 55022 Class A	FCC Part 15 Class A EN 55022 Class A
1200866E1	Serial NIM	FCC Part 15 Class A EN 55022 Class A EN 55024	FCC Part 15 Class A EN 55022 Class A EN 55024
1202843E1	Octal T1/E1 Wide Module	FCC Part 15 Class A EN 55022 Class A EN 55024	FCC Part 15 Class A EN 55022 Class A EN 55024
1200868E1/L1	E1/FE1 NIM	FCC Part 15 Class A EN 55022 Class A EN 55024	FCC Part 15 Class A EN 55022 Class A EN 55024
1200872L1 1202872L1	Dual T1 NIM	FCC Part 15 Class A EN 55022 Class A EN 55024	FCC Part 15 Class A EN 55022 Class A EN 55024
1200878E1/L1	E1/FE1 + G.703 Drop NIM	FCC Part 15 Class A EN 55022 Class A EN 55024	FCC Part 15 Class A EN 55022 Class A EN 55024
1202869E1 1202889E1	ADSL NIM, Annex A ADSL NIM, Annex B	FCC Part 15 Class A EN 55022 Class A EN 55024	FCC Part 15 Class A EN 55022 Class A EN 55024
1200936E1 1200937E1	SHDSL NIM, Annex A SHDSL NIM, Annex B	FCC Part 15 Class B EN 55022 Class B EN 55024	FCC Part 15 Class B EN 55022 Class B EN 55024
1702803F1	USB WWAN NIM	FCC Part 15 Class A EN 55022 Class B EN 55024	FCC Part 15 Class A EN 55022 Class B EN 55024
1202368L1	VPN Encryption (Accelerator) Card	FCC Part 15 Class A EN 55022 Class A EN 55024 EN 61000-3-2 EN 61000-3-3	N/A
1200864L1 1200865L1 1200875L1	Analog Modem DIM ISDN BRI DIM ISDN S/T DIM	FCC Part 15, Class A EN 55022 Class A EN 55024	FCC Part 15 Class A EN 55022 Class A EN 55024

## Industry Canada Compliance Information

Notice: The Industry Canada label applied to the product (identified by the Industry Canada logo or the “IC:” in front of the certification/registration number) signifies that the Industry Canada technical specifications were met.

Notice: The REN for this terminal equipment is supplied in the documentation or on the product labeling/markings. The REN assigned to each terminal device indicates the maximum number of terminals that can be connected to a telephone interface. The termination on an interface may consist of any combination of devices subject only to the requirement that the sum of the RENs of all the devices should not exceed five (5).

## Canadian Emissions Requirements

This digital apparatus does not exceed the Class A limits for radio noise emissions from digital apparatus as set out in the interference-causing equipment standard entitled “Digital Apparatus,” ICES-003 of the Department of Communications.

Cet appareil numérique respecte les limites de bruits radioélectriques applicables aux appareils numériques de Class A prescrites dans la norme sur le matériel brouilleur: “Appareils Numériques,” NMB-003 édictée par le ministre des Communications.

## Toll Fraud Liability

Be advised that certain security risks are inherent in the use of any telecommunications or networking equipment, including but not limited to, toll fraud, Denial of Service (DoS) attacks, loss or theft of data, and the unauthorized or illegal use of said equipment. ADTRAN OFFERS NO WARRANTIES, EITHER EXPRESSED OR IMPLIED, REGARDING THE PREVENTION, DETECTION, OR DETERRENCE OF TOLL FRAUD, NETWORKING ATTACKS, OR UNAUTHORIZED, ILLEGAL, OR IMPROPER USE OF ADTRAN EQUIPMENT OR SOFTWARE. THEREFORE, ADTRAN IS NOT LIABLE FOR ANY LOSSES OR DAMAGES RESULTING FROM SUCH FRAUD, ATTACK, OR IMPROPER USE, INCLUDING, BUT NOT LIMITED TO, HUMAN AND DATA PRIVACY, INTELLECTUAL PROPERTY, MATERIAL ASSETS, FINANCIAL RESOURCES, LABOR AND LEGAL COSTS. Ultimately, the responsibility for securing your telecommunication and networking equipment rests with you, and you are encouraged to review documentation regarding available security measures, their configuration and implementation, and to test such features as is necessary for your network.

## Service and Warranty

For information on the service and warranty of ADTRAN products, visit the [Support](#) section of the ADTRAN website at <http://www.adtran.com>.

# Table of Contents

<b>Introduction</b> .....	<b>12</b>
<b>Physical Descriptions</b> .....	<b>13</b>
NetVanta 4305 .....	13
NetVanta 4305 Features and Specifications .....	13
Network Interface Modules and Dial Backup Interface Modules Supported .....	13
NetVanta 4305 Shipping Contents .....	14
NetVanta 4305 Front Panel Design .....	15
NetVanta 4305 Rear Panel Design .....	15
NetVanta 4430 .....	16
NetVanta 4430 Features and Specifications .....	16
Network Interface Modules and Dial Backup Interface Modules Supported .....	17
SFP Module Slots .....	17
NetVanta 4430 Shipping Contents .....	17
NetVanta 4430 Rear Panel Design .....	19
NetVanta 4300/4400 Series Front Panel LEDs .....	20
<b>Option Modules</b> .....	<b>21</b>
Option Module Shipping Contents .....	22
Network Interface Modules .....	25
NetVanta 56K/64K NIM (P/N 1200861L1) .....	25
NetVanta T1/FT1 NIM (P/N 1202862L1) .....	26
NetVanta T1/FT1 NEBS NIM (P/N 1200862L2#NEBS) .....	27
NetVanta T1/FT1 + DSX-1 NIM (P/N 1202863L1) .....	28
NetVanta Dual T1 NIM (P/N 1200872L1/1202872L1) .....	29
NetVanta Octal T1/E1 Wide Module (P/N 1202843E1) .....	30
T1/E1 Mode DIP Switch .....	31
NetVanta E1/FE1 NIM (P/N 1200868E1/L1) .....	32
NetVanta E1/FE1 + G.703 Drop NIM (P/N 1200878E1/L1) .....	33
NetVanta Serial NIM (P/N 1200866E1) .....	34
NetVanta ADSL NIM, Annex A (P/N 1202869E1) .....	35
NetVanta ADSL NIM, Annex B (P/N 1202889E1) .....	36
NetVanta SHDSL NIM, Annex A (P/N 1200936E1) .....	37
NetVanta SHDSL NIM, Annex B (P/N 1200937E1) .....	38
NetVanta USB WWAN NIM (P/N 1702803F1) .....	39
Dial Backup Interface Modules .....	40
NetVanta Analog Modem DIM (P/N 1200864L1) .....	40
NetVanta ISDN BRI DIM (P/N 1200865L1) .....	41
NetVanta ISDN S/T DIM (P/N 1200875L1) .....	42
<b>Unit Installation</b> .....	<b>43</b>
Tools Required .....	44
Mounting Options .....	44
Rack Mounting NetVanta 4300/4400 Series .....	45
Wall Mounting NetVanta 4300/4400 Series .....	45
Supplying Power to the Unit .....	46
NetVanta 4305 (AC) and NetVanta 4430 .....	47
NetVanta 4305 (DC) .....	47
Installing Dial Backup and Network Interface Modules .....	49
Using a USB Cellular Modem with the NetVanta USB WWAN NIM .....	51



---

Installing the NetVanta VPN Accelerator Card (included in P/N 4200368L1) .....	52
Installing a SODIMM for Expandable Memory .....	53
Installing a CompactFlash Card .....	55
<b>Appendix A. Connector Pin Definitions.....</b>	<b>56</b>

## List of Figures

Figure 1.	NetVanta 4305 Front Panel Layout . . . . .	15
Figure 2.	NetVanta 4305 (AC version) Rear Panel Layout . . . . .	15
Figure 3.	NetVanta 4305 (DC version) Rear Panel Layout . . . . .	15
Figure 4.	NetVanta 4430 Front Panel Layout . . . . .	18
Figure 5.	NetVanta 4430 Rear Panel Layout . . . . .	19
Figure 6.	NetVanta 56K/64K NIM . . . . .	25
Figure 7.	NetVanta T1/FT1 NIM . . . . .	26
Figure 8.	NetVanta T1/FT1 NEBS NIM . . . . .	27
Figure 9.	NetVanta T1/FT1 + DSX-1 NIM . . . . .	28
Figure 10.	NetVanta Dual T1 NIM . . . . .	29
Figure 11.	NetVanta Octal T1/E1 Wide Module . . . . .	30
Figure 12.	NetVanta E1/FE1 NIM . . . . .	32
Figure 13.	NetVanta E1/FE1 + G.703 Drop NIM . . . . .	33
Figure 14.	NetVanta Serial NIM . . . . .	34
Figure 15.	NetVanta ADSL NIM, Annex A . . . . .	35
Figure 16.	NetVanta ADSL NIM, Annex B . . . . .	36
Figure 17.	NetVanta SHDSL NIM, Annex A . . . . .	37
Figure 18.	NetVanta SHDSL NIM, Annex B . . . . .	38
Figure 19.	NetVanta USB WWAN NIM . . . . .	39
Figure 20.	Wall Mounting the Unit . . . . .	46
Figure 21.	Installing DIMs . . . . .	49
Figure 22.	NIM and DIM Installation . . . . .	50
Figure 23.	NetVanta VPN Accelerator Card Installation . . . . .	52
Figure 24.	SODIMM Installation – Keyed Slots . . . . .	54
Figure 25.	SODIMM Installation – Applying Pressure . . . . .	54
Figure 26.	SODIMM Installation – Rotating the Module Downward . . . . .	54
Figure 27.	CompactFlash Card Installation . . . . .	55

## List of Tables

Table 1.	NetVanta 4300/4400 Series LEDs . . . . .	20
Table A-1.	10/100Base-T Ethernet Port Pinouts . . . . .	56
Table A-2.	1000Base-T Gigabit Ethernet Port Pinouts . . . . .	56
Table A-3.	SFP Slot Pinouts . . . . .	57
Table A-4.	CONSOLE Port (DCE) Pinouts . . . . .	57
Table A-5.	WAN-DDS Connector Pinouts . . . . .	58
Table A-6.	WAN-T1 Connector Pinouts . . . . .	58
Table A-7.	WAN-E1 Connector Pinouts . . . . .	58
Table A-8.	DSX-1 Connector Pinouts . . . . .	59
Table A-9.	G.703 Connector Pinouts . . . . .	59
Table A-10.	WAN-ADSL NIM Connector Pinouts . . . . .	59
Table A-11.	WAN-SHDSL Connector Pinouts . . . . .	59
Table A-12.	USB WWAN Connector Pinouts . . . . .	60
Table A-13.	Serial to Cable Pinouts . . . . .	60
Table A-14.	Analog Modem and ISDN BRI DBU Connector Pinouts . . . . .	61
Table A-15.	ISDN S/T DBU Connector Pinouts . . . . .	61

## 1. INTRODUCTION

The NetVanta 4300/4400 Series consists of the NetVanta 4305 AC, NetVanta 4305 DC, and the NetVanta 4430.



*In this document, the term NetVanta 4300/4400 means all of the units collectively. If a statement only applies to one particular router, the text refers to the router individually.*

This hardware installation guide lists the NetVanta 4300/4400 Series units' physical characteristics and product specifications, introduces basic functionality, and provides installation instructions.

- [Physical Descriptions on page 13](#)
- [Option Modules on page 21](#)
- [Unit Installation on page 43](#)

For additional information on mounting options, supplying power, upgrading memory, and installing a CompactFlash card, refer to the following sections:

- [Mounting Options on page 44](#)
- [Supplying Power to the Unit on page 46](#)
- [Installing Dial Backup and Network Interface Modules on page 49](#)
- [Using a USB Cellular Modem with the NetVanta USB WWAN NIM on page 51](#)
- [Installing a SODIMM for Expandable Memory on page 53](#)
- [Installing the NetVanta VPN Accelerator Card \(included in P/N 4200368L1\) on page 52](#)

For information on switch configuration for a specific application, refer to the configuration guides provided on the [ADTRAN Support Community](#). For details on the command line interface (CLI), refer to the [AOS Command Reference Guide](#). All other related documents are also available online at <http://supportforums.adtran.com>.

## 2. PHYSICAL DESCRIPTIONS

### NetVanta 4305

The NetVanta 4305 (AC or DC powered) is a mid-range IP router designed for medium- to large-office connectivity over Frame Relay or Point-to-Point Protocol (PPP) networks. This modular platform offers a complete solution for access routing and wide area network (WAN) connectivity in a single, compact package.

#### ***NetVanta 4305 Features and Specifications***

- Modular network interface: 56K/64K, T1/FT1, T1/FT1 NEBS, T1/FT1 + DSX-1, Dual T1, Octal T1/E1, E1/FE1, E1/FE1 + G.703 Drop, Serial, ADSL (Annex A or Annex B), SHDSL (Annex A or Annex B)
- 1U-high metal chassis with three slots for option modules
- Two integrated 10/100Base-T Ethernet ports (RJ-45)
- WAN Protocol: Frame Relay, Multilink Frame Relay, PPP, Multilink PPP, HDLC
- Integrated IP router with bridging
- RIP Versions 1 and 2, OSPF, and BGP routing protocols
- IP encapsulation over Frame Relay (RFC 1490)
- ADTRAN Operating System (AOS) CLI
- SNMP management
- n-Command® network management
- Integrated EIA-232 DCE configuration port (DB-9)
- Optional dial backup (ISDN BRI DIM, ISDN S/T DIM, or analog modem DIM)
- Optional VPN Accelerator Card provides encryption/decryption and security acceleration services
- Dimensions: 17.22-inch W x 1.72-inch H x 10.99-inch D
- Mountable in a 19-inch rack
- Power Supply: Worldwide auto-ranging AC or DC
- Operating Temperature: 0°C to 50°C
- RoHS compliant (Telecommunications exemption)

#### ***Network Interface Modules and Dial Backup Interface Modules Supported***

The main base unit supports a variety of interchangeable network interface modules (NIMs) and dial backup interface modules (DIMs). The NIMs available in this series provide a variety of WAN connectivity options, including the following:

- 56K/64K (DDS)
- T1/FT1
- T1/FT1 NEBS (NetVanta 4305 DC only)
- T1/FT1 + DSX-1
- Dual T1
- E1/FE1
- E1/FE1 + G.703 Drop
- Serial (V.35/X.21/EIA 530)

- ADSL, Annex A and Annex B
- SHDSL, Annex and Annex B
- Octal T1/E1 Wide Module (no external CSU/DSU needed)

If needed, an analog modem DIM, ISDN BRI U, or ISDN BRI S/T DIM can plug onto the NIM, providing dial backup capability. Refer to *Installing Dial Backup and Network Interface Modules on page 49* for more details.

For virtual private network (VPN) applications using the NetVanta 4305, the optional VPN Accelerator Card provides encryption/decryption and security acceleration services. Refer to *Installing the NetVanta VPN Accelerator Card (included in P/N 4200368L1) on page 52*.

### **NetVanta 4305 Shipping Contents**

Each NetVanta 4305 unit is shipped in its own cardboard shipping carton. Open each carton carefully, and avoid deep penetration into the carton with sharp objects.

After unpacking the unit, inspect it for possible shipping damage. If the equipment has been damaged in transit, immediately file a claim with the carrier and contact ADTRAN Customer Service (refer to the *Support* page on the ADTRAN website at <http://www.adtran.com/support>).

#### **NetVanta 4305 (AC version) Domestic Shipping Contents**

Domestic shipments of the NetVanta 4305 AC include the following items:

- NetVanta 4305 base unit with attached mounting ears
- Quick start guide
- Detachable AC power cord

#### **NetVanta 4305 (AC version) International Shipping Contents**

International shipments of the NetVanta 4305 AC include the following items:

- NetVanta 4305 base unit with attached mounting ears
- Quick start guide
- All necessary power cords

#### **NetVanta 4305 (DC version) Domestic Shipping Contents**

Domestic shipments of the NetVanta 4305 DC include the following items:

- NetVanta 4305 base unit with attached mounting ears
- Quick start guide



*Option module shipping contents are given in [Option Module Shipping Contents on page 22](#).*

### NetVanta 4305 Front Panel Design

The NetVanta 4305 front panel is shown below. Front panel LED descriptions are given in [Table 1 on page 20](#).

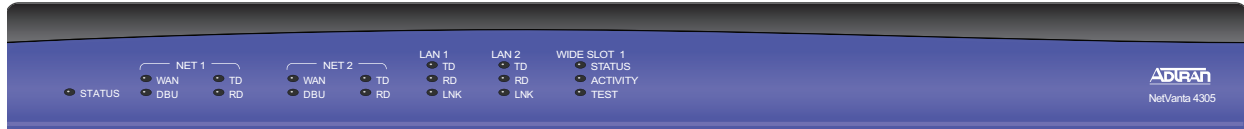

Figure 1. NetVanta 4305 Front Panel Layout

### NetVanta 4305 Rear Panel Design

[Figure 2](#) shows the NetVanta 4305 (AC) rear panel and [Figure 3](#) shows the NetVanta 4305 (DC) rear panel. The chassis are shown with the T1/FT1 + DSX-1 NIM installed.

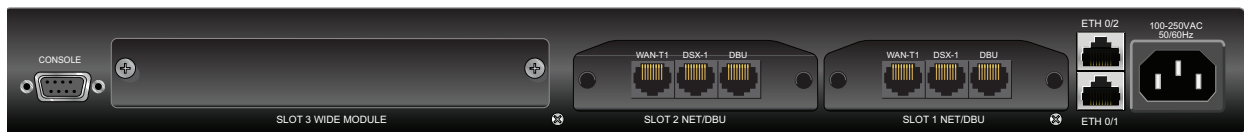

Figure 2. NetVanta 4305 (AC version) Rear Panel Layout

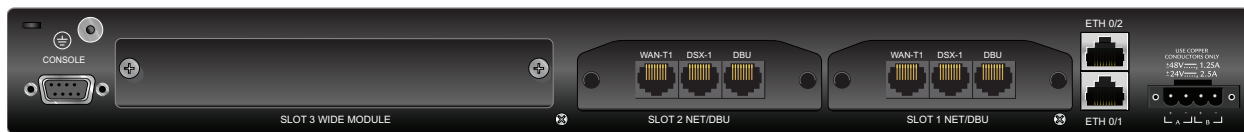

Figure 3. NetVanta 4305 (DC version) Rear Panel Layout

### Rear Panel Interfaces and LEDs

#### CONSOLE Interface

The **CONSOLE** interface is an EIA-232 serial port (DCE), which provides for local management and configuration (via a DB-9 female connector). [Table A-4 on page 57](#) shows the **CONSOLE** port pinouts.

**NOTE** *Connection directly to an external modem requires a cross-over cable.*

#### NET/DBU and Wide Module Option Slots

The **SLOT 3 WIDE MODULE** slot accepts the Octal T1/E1 Wide Module. The **SLOT 2 NET/DBU** and **SLOT 1 NET/DBU** option slots support various NIM plug-in modules. These option modules are described in the section [Option Modules on page 21](#).

### 10/100Base-T Ethernet Interface and Activity LEDs

The Ethernet ports (**ETH 0/1**, **ETH 0/2**) are RJ-45 connectors with LEDs. The yellow activity LED flashes when data traffic is being sent or received on the Ethernet port. The green link LED is on when the router has a good connection to the local area network (LAN). See [Table A-1 on page 56](#) for the Ethernet port pinouts. The Ethernet port provides the following:

- 10Base-T or 100Base-T with a single connector
- Auto-negotiation
- CSMA/CD
- IEEE 802.3 compatibility

### Power Supply

The NetVanta 4305 AC has a worldwide auto-ranging AC power supply with an IEC connector. The appropriate three-prong cable is included in the shipment. A 4-position terminal block is included in the shipment for connection of the NetVanta 4305 DC to a 24 or 48 VDC power source. Please refer to [Supplying Power to the Unit on page 46](#) for connection details.

## NetVanta 4430

The NetVanta 4430 is a mid-range IP router designed for medium- to large-office connectivity over Frame Relay or PPP networks. This modular platform offers a complete solution for access routing and WAN connectivity in a single, compact package.

### NetVanta 4430 Features and Specifications

- Modular network interface: 56K/64K, T1/FT1, T1/FT1 + DSX-1, Dual T1, Octal T1/E1, E1/FE1, E1/FE1 + G.703 Drop, Serial, ADSL (Annex A or Annex B), SHDSL (Annex A or Annex B), USB WWAN
- 1U-high metal chassis with three slots for option modules
- Two integrated 10/100/1000Base-T Gigabit Ethernet ports (RJ-45) for LAN/WAN connectivity via copper or fiber
- One integrated 10/100Base-T Ethernet port (RJ-45) for management
- 32 MB Flash memory
- Expandable Flash memory storage via a CompactFlash slot
- Expandable SDRAM with SODIMM module
- Integrated hardware encryption engine
- WAN Protocol: Frame Relay, Multilink Frame Relay, PPP, Multilink PPP, PPPoE, HDLC
- Stateful inspection firewall and VPN capabilities
- Integrated IP router with bridging
- RIP Versions 1 and 2, OSPF, and BGP routing protocols
- IP encapsulation over Frame Relay (RFC 1490)
- AOS CLI
- SNMP management
- n-Command network management
- Integrated RS-232 DCE configuration port (DB-9)
- Optional dial backup (ISDN BRI DIM, ISDN S/T DIM, or analog modem DIM)
- Dimensions: 17.22-inch W x 1.72-inch H x 10.99-inch D



- Mountable in a 19-inch rack
- Power Supply: Worldwide auto-ranging AC (120 to 240 VAC)
- Operating Temperature: 0°C to 50°C
- RoHS compliant (Telecommunications exemption)

### **Network Interface Modules and Dial Backup Interface Modules Supported**

The main base unit supports a variety of interchangeable NIMs and DIMs. The NIMs available in this series provide a variety of WAN connectivity options, including the following:

- 56K/64K (DDS)
- T1/FT1
- T1/FT1 + DSX-1
- Dual T1
- E1/FE1
- E1/FE1 + G.703 Drop
- Serial (V.35/X.21/EIA 530)
- ADSL, Annex A and Annex B
- SHDSL, Annex A and Annex B
- USB WWAN
- Octal T1/E1 Wide Module (no external CSU/DSU needed)

If needed, an analog modem DIM, ISDN BRI U, or ISDN BRI S/T DIM can plug onto the NIM, providing dial backup capability. Refer to *Installing Dial Backup and Network Interface Modules on page 49* for more details.

Refer to *Using a USB Cellular Modem with the NetVanta USB WWAN NIM on page 51* for details on installing and removing a USB cellular modem from the USB WWAN NIM.

### **SFP Module Slots**

The NetVanta 4430 has two small form-factor pluggable (SFP) slots that accept a number of industry standard SFP modules. The SFP modules provide Gigabit Ethernet fiber connectivity for high-speed uplinks. For a list of supported SFP modules, visit the ADTRAN website at <http://www.adtran.com>.

### **NetVanta 4430 Shipping Contents**

Each NetVanta 4430 unit is shipped in its own cardboard shipping carton. Open each carton carefully, and avoid deep penetration into the carton with sharp objects.

After unpacking the unit, inspect it for possible shipping damage. If the equipment has been damaged in transit, immediately file a claim with the carrier and contact ADTRAN Customer Service (refer to the *Support* page on the ADTRAN website at <http://www.adtran.com/support>).

### NetVanta 4430 Domestic Shipping Contents

Domestic shipments of the NetVanta 4430 include the following items:

- NetVanta 4430 base unit with attached mounting ears
- Quick start guide
- Detachable AC power cord

### NetVanta 4305 International Shipping Contents

International shipments of the NetVanta 4430 include the following items:

- NetVanta 4430 base unit with attached mounting ears
- Quick start guide
- All necessary power cords



*Option module shipping contents are given in [Option Module Shipping Contents](#) on page 22.*



*The NetVanta 4430 ships with a 200-pin, 256 MB SODIMM (P/N 1200813E1) installed. It can be upgraded to provide 512 MB using the 200-pin, 512 MB SODIMM (P/N 1200814E1).*

The NetVanta 4430 front panel is shown in [Figure 4](#). Front panel LED descriptions are given in [Table 1](#) on page 20.



**Figure 4. NetVanta 4430 Front Panel Layout**

### CONSOLE Interface

The **CONSOLE** interface is an RS-232 serial port (DCE), which provides for local management and configuration (via a DB-9 female connector). [Table A-4 on page 57](#) shows the **CONSOLE** port pinouts.



*Connection directly to an external modem requires a cross-over cable.*

### 10/100Base-T Ethernet Interface and Activity LEDs

The Ethernet port (**ETH 0/1**) is an RJ-48. See [Table A-1 on page 56](#) for the Ethernet port pinouts. The Ethernet port provides the following:

- 10Base-T or 100Base-T with a single connector
- Auto-negotiation
- CSMA/CD
- IEEE 802.3 compatibility
- Auto MDIX

### CompactFlash

The NetVanta 4430 front panel contains a **CompactFlash®** slot for nonvolatile configuration storage and compressed code storage. ADTRAN supports any industry standard 1 GB CompactFlash card. Refer to [Installing a CompactFlash Card on page 55](#).

### NetVanta 4430 Rear Panel Design

[Figure 5](#) shows the NetVanta 4430 rear panel. The chassis are shown with the T1/FT1 + DSX-1 NIM installed.

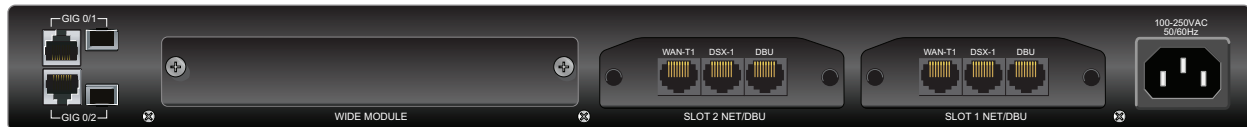

Figure 5. NetVanta 4430 Rear Panel Layout

### NetVanta 4430 Rear Panel Interfaces and LEDs

#### 10/100/1000Base-T Gigabit Ethernet Interfaces/SFP Slots

The Gigabit Ethernet ports (**GIG 0/1**, **GIG 0/2**) provide two fixed RJ-45 connectors with LEDs and two SFP slots for fiber connectivity. (Use either the RJ-45 connectors or the SFP slots. The fiber slots have precedence.) The RJ-45 LEDs reflect the activity on either the RJ-45 port or the SFP slot. The yellow activity LED flashes when data traffic is being sent or received. The green link LED is on when the router has a good connection to the LAN. See [Table A-1 on page 56](#) for the Ethernet port pinouts. The Ethernet port provides the following:

- 10Base-T, 100Base-T, or 1000Base-T via RJ-45
- 100Base-X or 1000Base-X via SFP
- Auto-negotiation
- CSMA/CD
- IEEE 802.3 compatibility
- Auto MDIX

#### NET/DBU and Wide Module Option Slots

The **WIDE MODULE** slot accepts the Octal T1/E1 Wide Module. The **SLOT 2 NET/DBU** and **SLOT 1 NET/DBU** option slots support various NIM plug-in modules. These option modules are described in the section [Option Modules on page 21](#).

#### Power Supply

The NetVanta 4430 has a worldwide auto-ranging AC power supply with an IEC connector. The appropriate three-prong cable is included in the shipment. Please refer to [Supplying Power to the Unit on page 46](#) for connection details.



*Previous versions of the NetVanta 4430 were equipped with either a 120 VAC, 50/60 Hz (1700630G1#120) or 240 VAC, 50/60 Hz (1700630G1#240) power supply. Plugging these units into an incompatible power source will damage the unit. Refer to the label on the unit before connecting the unit to the power source.*

## NetVanta 4300/4400 Series Front Panel LEDs

Table 1 describes the front panel LEDs.

**Table 1. NetVanta 4300/4400 Series LEDs**

LED	Color	Indication
<b>STATUS</b>	Green (flashing)	Unit is powering up. On power up, the <b>STAT</b> LED flashes rapidly for five seconds, during which time the user may escape to boot mode from the console port.
	Green (solid)	Power is on and self-test passed.
	Red (solid)	Power is on, but the self-test failed or the boot code could not be booted.
<b>NET 1/NET 2 WAN</b>	Off	No NIM is installed or interface is administratively down.
	Green (solid)	Link is up and everything is operational.
	Red (solid)	An alarm condition is occurring on the WAN interface, or there is a self-test failure.
	Amber (solid)	The unit is in test.
<b>NET 1/NET 2 DBU</b>	Off	No DIM is installed.
	Green (solid)	DIM is ready. For the ISDN BRI DIM, green solid indicates that the negotiation with the switch is complete.
	Green (flashing)	Unit is in dial backup.
	Red (solid)	An alarm condition is occurring on the DBU interface, or there is a self-test failure.
	Amber (solid)	Unit is in test.
<b>NET 1/NET 2 TD/RD</b>	Off	There is no activity on the WAN or DBU port.
	Green (flashing)	There is activity on the WAN or DBU port.
<b>LAN 1/LAN 2 TD/RD</b> (4305 only)	Off	There is no activity on the Ethernet port.
	Green (flashing)	There is activity on the Ethernet port.
<b>LAN 1/LAN 2 LNK</b> (4305 only)	Green (solid)	The 10Base-T Ethernet link is up.
	Amber (solid)	The 100Base-T Ethernet link is up.
<b>ETH 1 TD/RD</b> (4430 only)	Off	There is no activity on the Ethernet port.
	Green (flashing)	There is activity on the Ethernet port.
<b>ETH 1 LNK</b> (4430 only)	Off	The port is administratively down.
	Red (solid)	The port is administratively up and operational status is down.
	Green (solid)	The port is administratively up and operational status is up.
<b>GIG 1/GIG 2 TD/RD</b> (4430 only)	Off	There is no activity on the Gigabit Ethernet port.
	Green (flashing)	There is activity on the Gigabit Ethernet port.
<b>GIG 1/GIG 2 LNK</b> (4430 only)	Off	The port is administratively down.
	Red (solid)	The port is administratively up and operational status is down.
	Green (solid)	The port is administratively up and operational status is up.
<b>WIDE SLOT STATUS</b>	Off	The card is not installed.
	Green (solid)	The card is recognized by the system.
	Red (solid)	An alarm condition exists with the card.
<b>WIDE SLOT ACTIVITY</b>	Off	There is no activity on the card.
	Green (flashing)	There is data activity on the card (e.g., for the Octal T1 module, this indicates TD/RD data).
<b>WIDE SLOT TEST</b>	Off	There is no test running.
	Amber (solid)	The card is in test mode.

### 3. OPTION MODULES

The NetVanta 4300/4400 Series accepts several option modules designed to meet a variety of networking requirements. The option modules are of three types: plug-in NIMs, plug-on DIMs, and a wide NIM.

NIMs are cards that plug directly into the option module slot (labeled **SLOT 1 NET/DBU** or **SLOT 2 NET/DBU**), located on the rear of the base unit. These cards provide the following types of interfaces:

- [NetVanta 56K/64K NIM \(P/N 1200861L1\) on page 25](#)
- [NetVanta T1/FT1 NIM \(P/N 1202862L1\) on page 26](#)
- [NetVanta T1/FT1 NEBS NIM \(P/N 1200862L2#NEBS\) on page 27](#)
- [NetVanta T1/FT1 + DSX-1 NIM \(P/N 1202863L1\) on page 28](#)
- [NetVanta Dual T1 NIM \(P/N 1200872L1/1202872L1\) on page 29](#)
- [NetVanta E1/FE1 NIM \(P/N 1200868E1/L1\) on page 32](#)
- [NetVanta E1/FE1 + G.703 Drop NIM \(P/N 1200878E1/L1\) on page 33](#)
- [NetVanta Serial NIM \(P/N 1200866E1\) on page 34](#)
- [NetVanta ADSL NIM, Annex A \(P/N 1202869E1\) on page 35](#)
- [NetVanta ADSL NIM, Annex B \(P/N 1202889E1\) on page 36](#)
- [NetVanta SHDSL NIM, Annex A \(P/N 1200936E1\) on page 37](#)
- [NetVanta SHDSL NIM, Annex B \(P/N 1200937E1\) on page 38](#)
- [NetVanta USB WWAN NIM \(P/N 1702803F1\) on page 39](#)

Wide NIMs are modules that plug directly into the wide interface module slot (**WIDE MODULE**) located on the rear of the base unit. One wide NIM is available for use with the NetVanta 4300/4400 Series:

- [NetVanta Octal T1/E1 Wide Module \(P/N 1202843E1\) on page 30](#)

DIMs are plug-on cards that plug directly onto the NIM prior to installation into the base unit. A DIM must be plugged onto a NIM in order for the **DBU** port on the NIM to be active. The NetVanta 4300/4400 Series supports three different DIMs (only two can be installed simultaneously):

- [NetVanta Analog Modem DIM \(P/N 1200864L1\) on page 40](#)
- [NetVanta ISDN BRI DIM \(P/N 1200865L1\) on page 41](#)
- [NetVanta ISDN S/T DIM \(P/N 1200875L1\) on page 42](#)

This section describes each module, providing individual card shipping contents, specifications, and features. Refer to [Connector Pin Definitions on page 56](#) for pinout information. [Installing Dial Backup and Network Interface Modules on page 49](#) provides information on card installation.

Refer to [Using a USB Cellular Modem with the NetVanta USB WWAN NIM on page 51](#) for details on installing and removing the USB from the USB WWAN NIM.

## Option Module Shipping Contents

### **NetVanta 56K/64K NIM (1200861L1)**

Shipments of the 56K/64K NIM include the following items:

- 56K/64K Network Interface Module
- Quick start guide
- 6-foot RJ-45 to RJ-45 cable (ADTRAN P/N 3127004)

### **NetVanta T1/FT1 NIM (1202862L1)**

Shipments of the T1/FT1 NIM include the following items:

- T1/FT1 Network Interface Module
- Quick start guide
- 15-foot RJ-45 to RJ-45 cable (ADTRAN P/N 3125M008@A)

### **NetVanta T1/FT1 NEBS NIM (1200862L2#NEBS)**

Shipments of the T1/FT1 NEBS NIM include the following items:

- T1/FT1 NEBS Network Interface Module
- Quick start guide
- 15-foot RJ-45 to RJ-45 cable (ADTRAN P/N 3125M008@A)

### **NetVanta T1/FT1 + DSX-1 NIM (1202863L1)**

Shipments of the T1/FT1 + DSX-1 NIM include the following items:

- T1/FT1 + DSX-1 Network Interface Module
- Quick start guide
- 15-foot RJ-45 to RJ-45 cable (ADTRAN P/N 3125M008@A)

### **NetVanta Dual T1 NIM (1200872L1/1202872L1)**

Shipments of the Dual T1 NIM include the following items:

- Dual T1 Network Interface Module
- Quick start guide
- Two 15-foot RJ-45 to RJ-45 cable (ADTRAN P/N 3125M008@A)

### **NetVanta Octal T1/E1 Wide NIM (1202843E1)**

Shipments of the Octal T1/E1 Wide Option Module include the following items:

- Octal T1/E1 Wide Network Interface Module
- Quick start guide
- Eight 15-foot RJ-45 to RJ-45 cables (ADTRAN P/N 3125M008@A)

### **NetVanta E1/FE1 NIM (1200868E1/L1)**

Shipments of the E1/FE1 NIM include the following items:

- E1/FE1 Network Interface Module
- Quick start guide
- 15-foot RJ-45 to RJ-45 cable (ADTRAN P/N 3125M008@A)

**NetVanta E1/FE1 + G.703 Drop NIM (1200878E1/L1)**

Shipments of the E1/FE1 + G.703 Drop NIM include the following items:

- E1/FE1 + G.703 Network Interface Module
- Quick start guide
- 15-foot RJ-45 to RJ-45 cable (ADTRAN P/N 3125M008@A)

**NetVanta Serial NIM (1200866E1)**

Shipments of the Serial NIM include the following items:

- Serial Network Interface Module
- Quick start guide

**NetVanta ADSL NIM, Annex A (1202869E1)**

Shipments of the ADSL NIM, Annex A, include the following items:

- ADSL Network Interface Module
- Quick start guide
- 7-foot RJ-11 to RJ-11 cable (ADTRAN P/N 3127014)

**NetVanta ADSL NIM, Annex B (1202889E1)**

Shipments of the ADSL NIM, Annex B, include the following items:

- ADSL Network Interface Module
- Quick start guide
- 7-foot RJ-11 to RJ-11 cable (ADTRAN P/N 3127014)

**NetVanta SHDSL NIM, Annex A (1200936E1)**

Shipments of the SHDSL NIM, Annex A, include the following items:

- SHDSL Network Interface Module
- Quick start guide
- 15-foot RJ-45 to RJ-45 cable (ADTRAN P/N 3125M008@A)

**NetVanta SHDSL NIM, Annex B (1200937E1)**

Shipments of the SHDSL NIM, Annex B, include the following items:

- SHDSL Network Interface Module
- Quick start guide
- 15-foot RJ-45 to RJ-45 cable (ADTRAN P/N 3125M008@A)

**NetVanta USB WWAN (1702803F1)**

Shipments of the USB WWAN, include the following items:

- USB WWAN Network Interface Module
- Quick start guide

**NetVanta Analog Modem DIM (1200864L1)**

Shipments of the Analog Modem DIM include the following items:

- Analog Modem Dial Backup Interface Module
- Quick start guide
- 7-foot RJ-45 to RJ-11 cable (ADTRAN P/N 3125M007@A)

**NetVanta ISDN BRI DIM (1200865L1)**

Shipments of the ISDN BRI DIM include the following items:

- ISDN BRI Dial Backup Interface Module
- Quick start guide
- 7-foot RJ-45 to RJ-11 cable (ADTRAN P/N 3125M007@A)

**NetVanta ISDN S/T DIM (1200875L1)**

Shipments of the ISDN S/T DIM include the following items:

- ISDN S/T Dial Backup Interface Module
- Quick start guide
- 7-foot RJ-45 to RJ-11 cable (ADTRAN P/N 3125M007@A)

**NetVanta VPN Accelerator Card (1202368L1)**

Shipments of the VPN Accelerator Card include the following items:

- VPN Accelerator Card
- Quick start guide



*Option modules are intended to be serviced by qualified service personnel only.*



*System bundles are shipped with a base unit, a network interface module, and other appropriate contents based on the system-level solution ordered.*



## Network Interface Modules

### NetVanta 56K/64K NIM (P/N 1200861L1)

The 56K/64K NIM (shown in [Figure 6](#)) provides a **WAN-DDS** interface for the NetVanta 4300/4400 Series. See [Table A-5 on page 58](#) for the WAN-DDS connector pinouts, and see [Table A-14 on page 61](#) for the DBU connector pinouts. An optional DIM is required for dial backup applications.

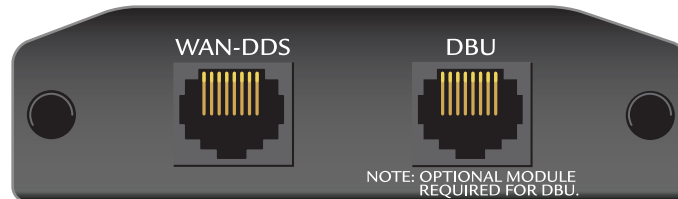

**Figure 6. NetVanta 56K/64K NIM**

### Features and Specifications

#### Operating Modes

- Dedicated DDS (leased line)

#### DDS Interface

- Supported Standards: AT&T TR 62310
- 4-wire, full-duplex
- Receiver Sensitivity: -45 dB, all rates
- Data Rates: 56K, 64K, and auto
- Connector: RJ-48C

#### Clock Source

- Network
- Internal

#### Diagnostics

- CSU and DSU Loopbacks

#### Compliance

- EMC - see [Electromagnetic Compatibility \(EMC\) Table on page 6](#).
- ACTA/FCC Part 68
- IC CS-03
- UL/CUL 60950-1

#### Environmental

- Operating Temperature: 0°C to 50°C
- Storage Temperature: -20°C to 70°C
- Relative Humidity: Up to 95 percent, noncondensing

#### Physical

- Dimensions: 2.75-inch W x 4.25-inch D

### NetVanta T1/FT1 NIM (P/N 1202862L1)

The T1/FT1 NIM (shown in [Figure 7](#)) provides a T1 (full T1 or fractional T1) WAN interface for the NetVanta 4300/4400 Series. See [Table A-6 on page 58](#) for the WAN-T1 connector pinouts and see [Table A-14 on page 61](#) for the DBU connector pinouts. An optional DIM is required for dial backup applications.

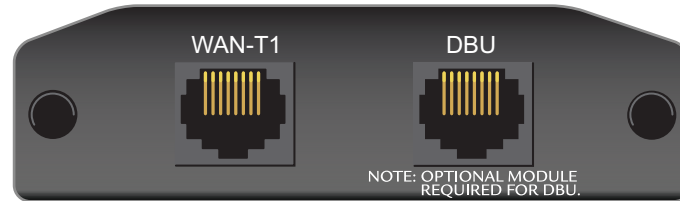

**Figure 7. NetVanta T1/FT1 NIM**

#### Features and Specifications

##### Operating Modes

- Frame Relay, Multilink Frame Relay
- PPP, Multilink PPP
- HDLC

##### T1/FT1 Interface

- Supported Standards: AT&T TR 62411, AT&T TR 65016, ANSI T1.403, Bellcore TR 194
- Line Rate: 1.544 Mbps  $\pm$ 75 bps
- Line Code: AMI or B8ZS
- Framing: D4 (SF) or ESF
- FT1 Line Rate: DS0 channelized (multiples of 64 kbps)
- Input Signal: 0 to -36 dB (DS1)
- Line Build Out: 0, -7.5, -15, -22.5 dB (long), 0 to 655 ft (short)
- DS0 Assignment: Programmable
- Connector: RJ-48C

##### Clock Source

- Network
- Internal

##### Diagnostics

- Test Pattern Generation and Detection: 511, QRSS, all ones, all zeros
- Network loopbacks (local and remote); responds to both inband and FDL loop codes
- Alarm generation and detection
- Network and user sets of performance data (15 minutes and 24 hours)

##### Compliance

- EMC - see [Electromagnetic Compatibility \(EMC\) Table on page 6](#).
- ACTA/FCC Part 68
- IC CS-03
- UL/CUL 60950-1

##### Environmental

- Operating Temperature: 0°C to 50°C
- Storage Temperature: -20°C to 70°C
- Relative Humidity: Up to 95 percent, noncondensing

##### Physical

- Dimensions: 2.75-inch W x 4.25-inch D

### NetVanta T1/FT1 NEBS NIM (P/N 1200862L2#NEBS)

The T1/FT1 NEBS NIM (see [Figure 8](#)) T1 WAN interface for the NetVanta 4305 DC. The T1 NEBS NIM is NEBS Level 3 compliant, and provides a full or fractional T1 network interface. See [WAN-T1 Connector Pinouts on page 58](#) for the WAN-T1 connector pinouts.



**Figure 8. NetVanta T1/FT1 NEBS NIM**

#### Features and Specifications

##### Operating Modes

- Frame Relay, Multilink Frame Relay
- PPP, Multilink PPP
- HDLC

##### T1/FT1 Interface

- Supported Standards: AT&T TR 62411, AT&T TR 65016, ANSI T1.403, Bellcore TR 194
- Line Rate: 1.544 Mbps  $\pm$ 75 bps
- Line Code: AMI or B8ZS
- Framing: D4 (SF) or ESF
- FT1 Line Rate: DS0 channelized (multiples of 64 kbps)
- Input Signal: 0 to -36 dB (DS1)
- Line Build Out: 0, -7.5, -15, -22.5 dB (long), 0 to 655 ft (short)
- DS0 Assignment: Programmable
- Connector: RJ-48C

##### Clock Source

- Network
- Internal

##### Diagnostics

- Test Pattern Generation and Detection: QRSS, 511,  $2^{15} - 1$ ,  $2^{20} - 1$ , all ones, all zeros
- Network loopbacks (local and remote); responds to inband and FDL loop codes
- Alarm generation and detection
- Network and user sets of performance data (15 minutes and 24 hours)

##### Compliance

- EMC - see [Electromagnetic Compatibility \(EMC\) Table on page 6](#).
- NEBS Level 3
- GR-63-CORE
- GR-1089-CORE
- UL/CUL 60950-1

##### Environmental

- Operating Temperature: 0°C to 50°C
- Storage Temperature: -20°C to 70°C
- Relative Humidity: Up to 95 percent, noncondensing

##### Physical

- Dimensions: 2.75-inch W x 4.25-inch D

### NetVanta T1/FT1 + DSX-1 NIM (P/N 1202863L1)

The T1/FT1 + DSX-1 NIM (see [Figure 9](#)) provides a full T1 or fractional T1 network interface and a DSX-1 interface. See [Table A-6 on page 58](#) for the WAN-T1 connector pinouts, [Table A-8 on page 59](#) for the DSX-1 connector pinouts, and [Table A-14 on page 61](#) for the DBU connector pinouts. An optional DIM is required for dial backup applications.

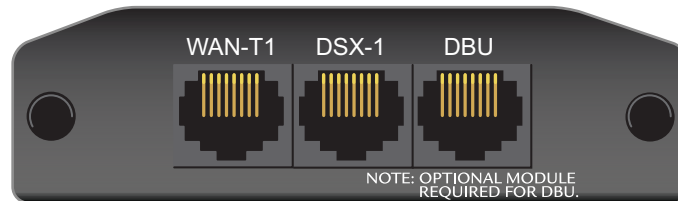

**Figure 9. NetVanta T1/FT1 + DSX-1 NIM**

#### Features and Specifications

##### Operating Modes

- Frame Relay, Multilink Frame Relay
- PPP, Multilink PPP
- HDLC

##### T1/FT1 Interface

- Supported Standards: AT&T TR 62411, AT&T TR 65016, ANSI T1.403, Bellcore TR 194
- Line Rate: 1.544 Mbps  $\pm$ 75 bps
- Line Code: AMI or B8ZS
- Framing: D4 (SF) or ESF
- FT1 Line Rate: DS0 channelized (multiples of 56/64 kbps)
- Input Signal: 0 to -36 dB (DS1)
- Line Build Out: 0, -7.5, -15, -22.5 dB (long), 0 to 655 ft (short)
- DS0 Assignment: Programmable
- Connector: RJ-48C

##### DSX-1 Interface

- Line Interface: DSX-1 per ANSI T1.102
- DSX Receiver Input Range: -10 dBdsx to +6 dBdsx
- Line Rate: 1.544 Mbps
- Capacity: 1 to 24 DS0s
- Line Codes: AMI, B8ZS
- DSX-1 Interface to PBX
- Framing: D4 (SF) or ESF
- Line Length: 0 to 655 feet and -7.5 dB
- Connector: RJ-48C

##### Clock Source

- Network
- Internal
- Through

##### Diagnostics

- Test Pattern Generation and Detection: 511, QRSS, all ones, all zeros
- Network loopbacks (local and remote); responds to inband and FDL loop codes (T1 interface only)
- Alarm generation and detection
- Network and user sets of performance data (15 minutes and 24 hours)

##### Compliance

- EMC - see [Electromagnetic Compatibility \(EMC\) Table on page 6](#).
- ACTA/FCC Part 68
- IC CS-03
- UL/CUL 60950-1

##### Environmental

- Operating Temperature: 0°C to 50°C
- Storage Temperature: -20°C to 70°C
- Relative Humidity: Up to 95 percent, noncondensing

##### Physical

- Dimensions: 2.75-inch W x 4.25-inch D

### NetVanta Dual T1 NIM (P/N 1200872L1/1202872L1)

The NetVanta Dual T1 NIM (see [Figure 10](#)) provides two WAN T1 interfaces for the NetVanta 4300/4400 Series. The module provides up to 2.048 Mbps on each network interface. See [Table A-6 on page 58](#) for the pinouts. See [Table A-14 on page 61](#) for the DBU connector pinouts. An optional DIM is required for dial backup applications.

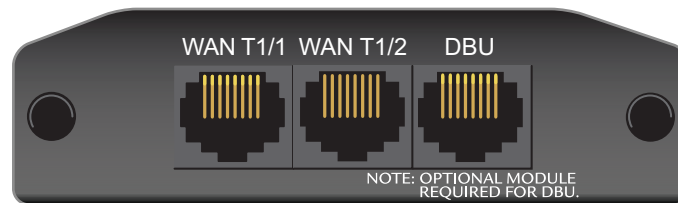

**Figure 10. NetVanta Dual T1 NIM**  
**Features and Specifications**

#### Operating Modes

- Frame Relay, Multilink Frame Relay
- PPP, Multilink PPP
- HDLC

#### T1 Interface

- Supported Standards: AT&T TR 62411, AT&T TR 65016, ANSI T1.403, Bellcore TR 194
- Line Rate: 1.544 Mbps  $\pm$ 75 bps
- Line Code: AMI or B8ZS
- Framing: D4 (SF) or ESF
- FT1 Line Rate: DS0 channelized (multiples of 64 kbps)
- Input Signal: 0 to -36 dB (DS1)
- Line Build Out: 0, -7.5, -15, -22.5 dB (long), 0 to 655 ft (short)
- DS0 Assignment: Programmable
- Connector: RJ-48C

#### Clock Source

- Network
- Internal
- Through

#### Diagnostics

- Test Pattern Generation and Detection: QRSS, 511,  $2^{15} - 1$ ,  $2^{20} - 1$ , all ones, all zeros
- Network loopbacks (local and remote); responds to both inband and FDL loop codes
- Alarm generation and detection
- Network performance data (15 minutes and 24 hours)

#### Compliance

- EMC - see [Electromagnetic Compatibility \(EMC\) Table on page 6](#).
- ACTA/FCC Part 68
- IC CS-03
- UL/CUL 60950-1

#### Environmental

- Operating Temperature: 0°C to 50°C
- Storage Temperature: -20°C to 70°C
- Relative Humidity: Up to 95 percent, noncondensing

#### Physical

- Dimensions: 2.75-inch W x 4.25-inch D



*The 1200872L1 Dual T1 module supports the analog modem (1200864L1), ISDN BRI (1200865L1), and ISDN S/T (1200875L1) DIMs for dial backup applications. The 1202872L1 Dual T1 module supports only the analog modem (1200864L1) DIM for dial backup applications.*

### NetVanta Octal T1/E1 Wide Module (P/N 1202843E1)

The NetVanta Octal T1/E1 Wide Module second generation (shown in [Figure 11](#)) provides eight T1 or E1 interfaces with RJ-45 wire connections. These interfaces can be used independently or as aggregate bandwidth using Multilink PPP Protocol (MLPPP). [Table A-6 on page 58](#) and [Table A-7 on page 58](#) give the pinouts for this module.

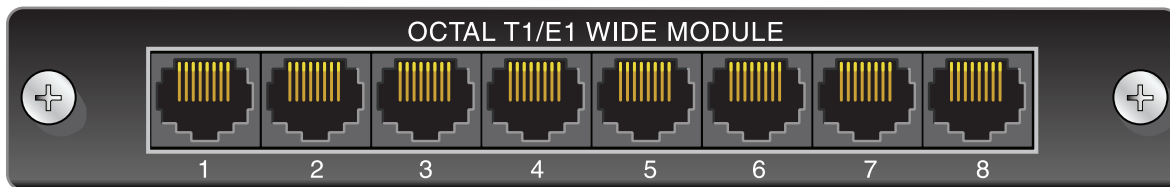

**Figure 11. NetVanta Octal T1/E1 Wide Module**

#### Features and Specifications

##### Operating Modes

- Frame Relay, Multilink Frame Relay
- PPP, Multilink PPP
- HDLC



*A DIP switch on the circuit board selects either T1 or E1 operation. All eight ports are either T1 or E1. The default is T1. Refer to [T1/E1 Mode DIP Switch on page 31](#) for more information.*

##### 8xT1 Interfaces

- Supported Standards: AT&T TR 62411, AT&T 54016, ANSI T1.403, Bellcore TR 194
- Line Rate: 1.544 Mbps  $\pm$ 75 bps
- Line Code: AMI or B8ZS
- Framing: D4 (SF) or ESF
- FT1 Line Rate: DS0 channelized (multiples of 64 kbps)
- Input Signal: 0 to -36 dB (DS1); Support for Nx64 on all T1 interfaces
- Line Build Out: 0, -7.5, -15, -22.5 dB (long), 0 to 655 ft (short)
- DS0 Assignment: Programmable

##### 8xE1 Interfaces

- Supported Standards: ITU G.703, ITU-T G704 (CRC-4), ITU-T G823, ITU-T G.797
- Line Rate: 2.048 Mbps  $\pm$ 50 PPM
- Line Code: AMI or HDB3
- Framing: FAS/NFAS with optional CRC-4
- Input Signal: 0 to -30 dB (DS1) on all E1 interfaces (1 through 8)
- FE1 Line Rate: Channelized timeslot (in multiples of 64 kbps)
- Connector: RJ-48C



*A different service provider can be used on each interface. Each interface has an independent clock.*

**Clock Source**

- Network
- Internal

**Diagnostics**

- Network Loopbacks: Line, payload, remote
- Test Pattern Generation and Detection: QRSS,  $2^{15} - 1$ , 511, all ones, all zeros

**Compliance**

- EMC - see *Electromagnetic Compatibility (EMC) Table on page 6*.
- AS/ACIF S016
- ETSI TBR 12/TBR 13
- ACTA/FCC Part 68
- IC CS-03
- UL/CUL 60950-1
- EN 60950-1
- IEC 60950-1
- AS/NZS 60950-1
- RoHS Compliant (1202843E1 only) (Telecommunications exemption)

**Environmental**

- Operating Temperature: 0°C to 50°C
- Storage Temperature: -20°C to 70°C
- Relative Humidity: 95 percent, noncondensing

**Physical**

- 5.63-inch W x 8.63-inch D



*No external CSU/DSU is needed with the T1/FT1 interface.*

**T1/E1 Mode DIP Switch**

The T1/E1 Wide Module is shipped with the T1/E1 mode switch (located on the circuit board) set to T1. If you require E1 functionality, use your thumbnail to slide the E1 mode switch to the **ON** position (as shown in the figure below).



Switch Set to T1 Mode



Switch Set to E1 Mode

### NetVanta E1/FE1 NIM (P/N 1200868E1/L1)

The NetVanta E1/FE1 NIM (see [Figure 12](#)) provides a **WAN-E1** interface for the NetVanta 4300/4400 Series meeting the requirements of ITU-T G.703/G.704. The module provides a single 2.048 Mbps network interface. See [Table A-7 on page 58](#) for the pinouts. See [Table A-14 on page 61](#) for the DBU connector pinouts. An optional DIM is required for dial backup applications.

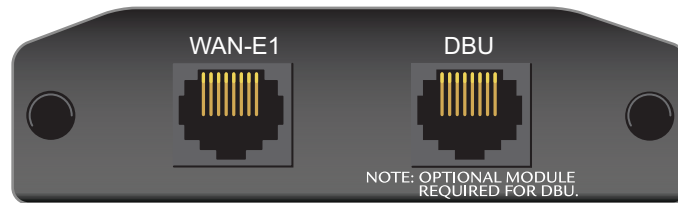

**Figure 12. NetVanta E1/FE1 NIM**

#### Features and Specifications

##### Operating Modes

- Frame Relay, Multilink Frame Relay
- PPP, Multilink PPP
- HDLC

##### WAN-E1 Interface

- Supported Standards: ITU G.703, ITU-T G.704 (CRC-4), ITU-T G.823, ITU-T G.797
- Line Rate: 2.048 Mbps  $\pm$ 50 PPM
- Line Code: AMI or HDB3
- Framing: FAS with optional CRC-4
- FE1 Line Rate: Channelized timeslot (in multiples of 64 kbps)
- Receiver Sensitivity: -30 dB
- Connector: RJ-48C

##### Clock Source

- Network
- Internal

##### Diagnostics

- Test Pattern Generation and Detection: QRSS, 511, all ones, all zeros
- Network loopbacks
- Network performance data (15 minutes and 24 hours)
- Alarm generation and detection

##### Compliance

- EMC - see [Electromagnetic Compatibility \(EMC\) Table on page 6](#).
- AS/ACIF S016
- ETSI TBR 12/TBR 13
- EN 60950-1
- IEC 60950-1
- AS/NZS 60950-1
- RoHS Compliant (1200868E1 only) (Telecommunications exemption)

##### Environmental

- Operating Temperature: 0°C to 50°C
- Storage Temperature: -20°C to 70°C
- Relative Humidity: Up to 95 percent, noncondensing

##### Physical

- Dimensions: 2.75-inch W x 4.25-inch D



### NetVanta E1/FE1 + G.703 Drop NIM (P/N 1200878E1/L1)

The NetVanta E1/FE1 + G.703 Drop NIM (see [Figure 13](#)) provides a single **WAN-E1** interface (2.043 Mbps) with user-selectable TS0 assignment and a G.703 drop port, which may be used to drop and insert traffic to an E1 PBX. See [Table A-7 on page 58](#) for the E1 pinouts. See [Table A-9 on page 59](#) for the G.703 pinouts. See [Table A-14 on page 61](#) for the DBU connector pinouts. An optional DIM is required for dial backup applications.

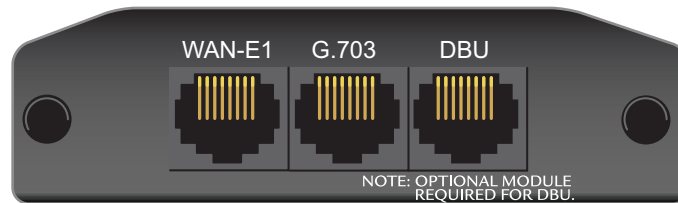

**Figure 13. NetVanta E1/FE1 + G.703 Drop NIM**

#### Features and Specifications

##### Operating Modes

- Frame Relay, Multilink Frame Relay
- PPP, Multilink PPP
- HDLC

##### WAN-E1 Interface

- Supported Standards: ITU G.703, ITU-T G.704 (CRC-4), ITU-T G.823, ITU-T G.797
- Line Rate: 2.048 Mbps  $\pm$ 50 PPM
- Line Code: AMI or HDB3
- Framing: FAS with optional CRC-4
- FE1 Line Rate: Channelized timeslot (in multiples of 64 kbps)
- Receiver Sensitivity: -30 dB
- Connector: RJ-48C

##### G.703 Interface

- Receiver Sensitivity: -30 dB
- Line Rate: 2.048 Mbps  $\pm$ 50 PPM
- Line Code: AMI or HDB3
- Framing: FAS with optional CRC-4
- Capacity: 1 to 31 timeslots
- Connector: RJ-48C

##### Clock Source

- Network
- Internal
- Through

##### Diagnostics

- Test Pattern Generation and Detection: QRSS, 511, all ones, all zeros
- Network loopbacks
- Network performance data (15 minutes and 24 hours)
- Alarm generation and detection

##### Compliance

- EMC - see [Electromagnetic Compatibility \(EMC\) Table on page 6](#).
- AS/ACIF S016
- ETSI TBR 12/TBR 13
- EN 60950-1
- IEC 60950-1
- AS/NZS 60950-1
- RoHS Compliant (1200878E1 only) (Telecommunications exemption)

##### Environmental

- Operating Temperature: 0°C to 50°C
- Storage Temperature: -20°C to 70°C
- Relative Humidity: Up to 95 percent, noncondensing

##### Physical

- Dimensions: 2.75-inch W x 4.25-inch D

### NetVanta Serial NIM (P/N 1200866E1)

The NetVanta Serial NIM (shown in [Figure 14](#)) can be configured by the user as a V.35, an X.21 (V.11), or an EIA 530 interface. This module supports rates up to a maximum of 10 Mbps. An additional V.35 (ADTRAN P/N 1200873L1), X.21 (ADTRAN P/N 1200874L1), or EIA 530 (P/N 1200883L1) cable is required (see *Caution* below). See [Table A-13 on page 60](#) for the Serial connector pinouts, and [Table A-14 on page 61](#) for the DBU connector pinouts. An optional DIM is required for dial backup applications.

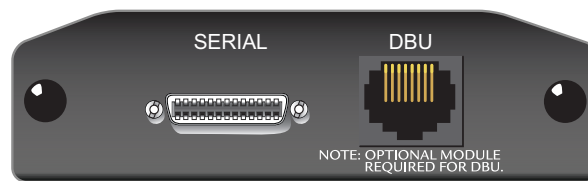
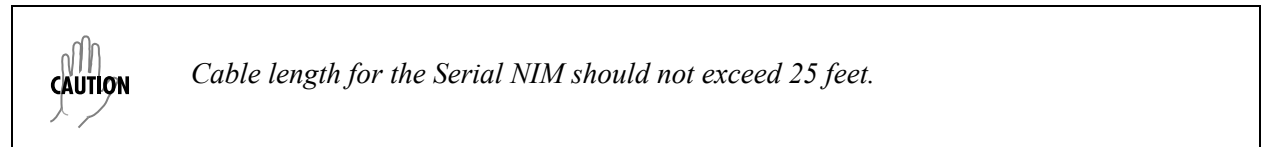

**Figure 14. NetVanta Serial NIM**

#### Features and Specifications

##### Operating Mode

- DTE only

##### Serial Interface

- Supported Standards: ISO 4903 (X.21), CCITT V.35 Synchronous (V.35), EIA 530 Synchronous
- Provides V.35, X.21 (V.11), or EIA 530 electrical interface
- Connector: 26-pin smart serial (DTE)

##### Compliance

- EMC - see [Electromagnetic Compatibility \(EMC\) Table on page 6](#).
- ETSI TBR1
- ETSI TBR2
- EN 60950-1
- IEC 60950-1
- UL/CUL 60950-1
- AS/NZS 60950-1
- RoHS Compliant (1200866E1 only) (Telecommunications exemption)

##### Environmental

- Operating Temperature: 0°C to 50°C
- Storage Temperature: -20°C to 70°C
- Relative Humidity: Up to 95 percent, noncondensing

##### Physical

- Dimensions: 2.75-inch W x 4.25-inch D

**NetVanta ADSL NIM, Annex A (P/N 1202869E1)**

The NetVanta ADSL, Annex A (see [Figure 15](#)) adds ADSL capability to the NetVanta 4300/4400 Series. The module provides a single ADSL, ADSL2, or ADSL2+ network interface to support rates up to 25 Mbps. See [Table A-10 on page 59](#) for the pinouts. See [Table A-14 on page 61](#) for the DBU connector pinouts. An optional DIM is required for dial backup applications.

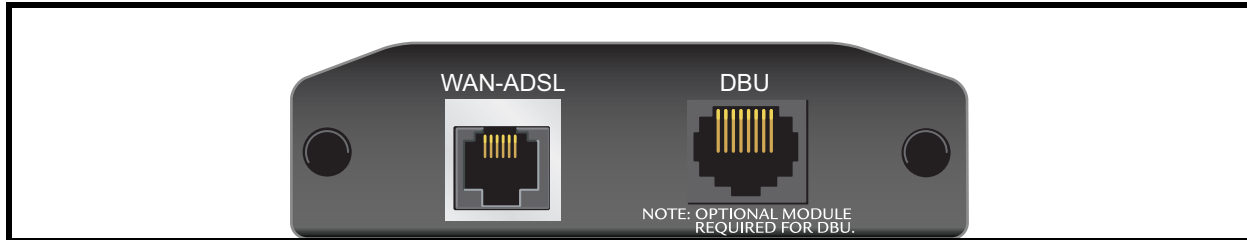

**Figure 15. NetVanta ADSL NIM, Annex A**

**Features and Specifications**

**DSL Interface**

- ADSL over POTS, Annex A
- Supported Standards:
  - ITU-T G.992.1 Annex A (G.dmt)
  - ITU-T G.992.2 Annex A (G.lite)
  - ITU-T G.992.3 Annex A ADSL2 (G.dmt.bis)
  - ITU-T G.992.5 Annex A ADSL2+
  - ITU-T G.992.3 Annex L READSL2
  - ANSI T1.413 Issue 2
- Connector: RJ-1C (6-pin jack, inner pair)

**ATM**

- Multiple Protocol over AAL5 (RFC 2684)
- PPP over ATM (RFC 2364)
- PPP over Ethernet (RFC 2516)
- ATM Forum UNI 3.1/4.0 PVC
- ATM class of service (UBR)
- ATM F5 OAM
- Up to 16 virtual circuits

**Compliance**

- EMC - see [Electromagnetic Compatibility \(EMC\) Table on page 6](#).
- ACTA/FCC Part 68
- AS/ACIF S043
- AS/ACIF S002
- IC CS-03
- EN 60950-1
- IEC 60950-1
- UL/CUL 60950-1
- AS/NZS 60950-1
- RoHS Compliant (1200869E1 only) (Telecommunications exemption)

**Environmental**

- Operating Temperature: 0°C to 50°C
- Storage Temperature: -20°C to 70°C
- Relative Humidity: Up to 95 percent, noncondensing

**Physical**

- Dimensions: 2.75-inch W x 4.25-inch D

### NetVanta ADSL NIM, Annex B (P/N 1202889E1)

The NetVanta ADSL, Annex B (see [Figure 16](#)) adds ADSL capability to the NetVanta 4300/4400 Series. The module provides a single 2.048 Mbps network interface. See [Table A-10 on page 59](#) for the pinouts. See [Table A-14 on page 61](#) for the DBU connector pinouts. An optional DIM is required for dial backup applications.

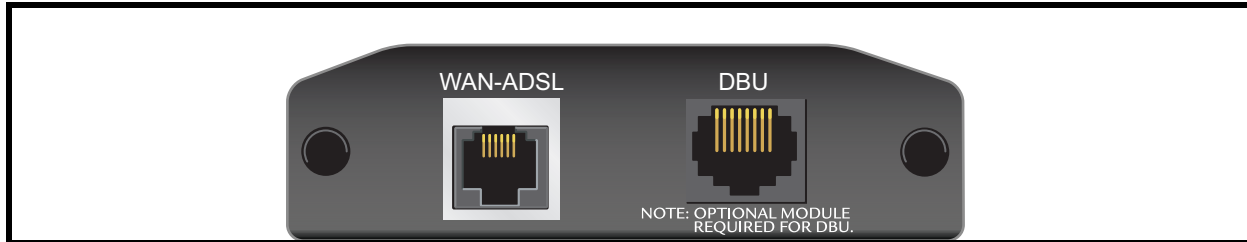

Figure 16. NetVanta ADSL NIM, Annex B

#### Features and Specifications

##### ADSL Interface

- ADSL over ISDN, Annex B
- Supported Standards: ITU-T G.992.1 Annex B (G.dmt)
- Connector: RJ-11C (6-pin jack, inner pair)

##### ATM

- Multiple Protocol over AAL5 (RFC 2684)
- PPP over ATM (RFC 2364)
- PPP over Ethernet (RFC 2516)
- ATM Forum UNI 3.1/4.0 PVC
- ATM class of service (UBR)
- ATM F5 OAM
- Up to 16 virtual circuits

##### Compliance

- EMC - see [Electromagnetic Compatibility \(EMC\) Table on page 6](#).
- AS/ACIF S043
- EN 60950-1
- IEC 60950-1
- AS/NZS 60950-1
- RoHS Compliant (1200889E1 only) (Telecommunications exemption)

##### Environmental

- Operating Temperature: 0°C to 50°C
- Storage Temperature: -20°C to 70°C
- Relative Humidity: Up to 95 percent, noncondensing

##### Physical

- Dimensions: 2.75-inch W x 4.25-inch D

### NetVanta SHDSL NIM, Annex A (P/N 1200936E1)

The NetVanta SHDSL NIM, Annex A (shown in [Figure 17](#)) provides a WAN-SHDSL interface for the NetVanta 4000 Series. See [Table A-11 on page 59](#) for the SHDSL connector pinouts.



**Figure 17. NetVanta SHDSL NIM, Annex A**

#### Features and Specifications

##### Operating Mode

- Line termination (CO)
- Network termination (CPE)

##### G.SHDSL Interface

- Supported Standards: ITU-T G.991.2, SHDSL Annex A
- M-pair bonding of 2 pairs - ITU-T G.991.2
- Line Rate (2-wire mode): 192 to 2304 kbps in 64k increments
- Line Rate (4-wire mode): 384 to 4608 kbps in 128k increments
- Payload: ATM (AAL5)
- Line Code: TC-PAM
- Connector: RJ-45

##### Clock Source

- CPE Operating Mode: Network
- CO Operating Mode: Internal

##### Diagnostics

- Network loopbacks (local and remote)
- Alarm generation and detection
- Programmable alarm threshold setting for loop attenuation and signal-to-noise ratio

##### Compliance

- EMC - see [Electromagnetic Compatibility \(EMC\) Table on page 6](#).
- ACTA/FCC Part 68
- UL/CUL 60950-1
- RoHS Compliant (Telecommunications exemption)

##### Environmental

- Operating Temperature: 0°C to 50°C
- Storage Temperature: -20°C to 70°C
- Relative Humidity: Up to 95 percent, noncondensing

##### Physical

- Dimensions: 2.75-inch W x 4.25-inch D

### NetVanta SHDSL NIM, Annex B (P/N 1200937E1)

The NetVanta SHDSL NIM, Annex B (shown in [Figure 18](#)) provides a WAN-SHDSL interface for the NetVanta 4000 Series. See [Table A-11 on page 59](#) for the SHDSL connector pinouts.



**Figure 18. NetVanta SHDSL NIM, Annex B**

#### Features and Specifications

##### Operating Mode

- Line termination (CO)
- Network termination (CPE)

##### G.SHDSL Interface

- Supported Standards: ITU-T G.991.2, SHDSL Annex B
- M-pair bonding of 2 pairs - ITU-T G.991.2
- Line Rate (2-wire mode): 192 to 2304 kbps in 64k increments
- Line Rate (4-wire mode): 384 to 4608 kbps in 128k increments
- Payload: ATM (AAL5)
- Line Code: TC-PAM
- Connector: RJ-45

##### Clock Source

- CPE Operating Mode: Network
- CO Operating Mode: Internal

##### Diagnostics

- Network loopbacks (local and remote)
- Alarm generation and detection
- Programmable alarm threshold setting for loop attenuation and signal-to-noise ratio

##### Compliance

- EMC - see [Electromagnetic Compatibility \(EMC\) Table on page 6](#).
- AS/ACIF S043
- EN 60950-1
- AS/NZS 60950-1
- RoHS Compliant (Telecommunications exemption)

##### Environmental

- Operating Temperature: 0°C to 50°C
- Storage Temperature: -20°C to 70°C
- Relative Humidity: Up to 95 percent, noncondensing

##### Physical

- Dimensions: 2.75-inch W x 4.25-inch D

**NetVanta USB WWAN NIM (P/N 1702803F1)**

The NetVanta USB WWAN NIM (shown in *Figure 19*) provides a USB interface for the NetVanta 4430 only. For specific connection and configuration instructions, refer to the *NetVanta USB WWAN NIM Quick Start Guide* or the *USB WWAN NIM and the Cellular Interface Configuration Guide* available on ADTRAN's Support Forum (<https://supportforums.adtran.com>). See *Table A-12 on page 60* for the USB WWAN connector pinouts.



**Figure 19. NetVanta USB WWAN NIM**

**Features and Specifications****USB Interface**

- Supported Standards: USB 2.0
- Connector: USB Type A

**Compliance**

- EMC - see *Electromagnetic Compatibility (EMC) Table on page 6*.
- EN 60950-1
- IEC 60950-1
- UL/CUL 60950-1
- AS/NZS 60950-1
- RoHS Compliant

**Environmental**

- Operating Temperature: 0°C to 50°C
- Storage Temperature: -20°C to 70°C
- Relative Humidity: Up to 95 percent, noncondensing

**Physical**

- Dimensions: 2.75-inch W x 4.25-inch D

## Dial Backup Interface Modules

### **NetVanta Analog Modem DIM (P/N 1200864L1)**

The Analog Modem DIM provides a modem with data rates up to 33.6 kbps. This DIM is a plug-on card that connects to the NIM. For installation instructions, refer to [Installing Dial Backup and Network Interface Modules on page 49](#).

#### **Features and Specifications**

##### **Features**

- ITU V.90 compliant
- Async

##### **Compliance**

- EMC - see [Electromagnetic Compatibility \(EMC\) Table on page 6](#).
- ACTA/FCC Part 68
- IC CS-03
- UL/CUL 60950-1

##### **Environmental**

- Operating Temperature: 0°C to 50°C
- Storage Temperature: -20°C to 70°C
- Relative Humidity: Up to 95 percent, noncondensing

##### **Physical**

- Dimensions: 2.5-inch W x 3.75-inch D



*The Analog Modem DIM can be used in two different modes:*

- 1. Backup interface for a primary connection.*
- 2. CONSOLE port for remote dial-in access.*



**NetVanta ISDN BRI DIM (P/N 1200865L1)**

The NetVanta ISDN BRI DIM provides dial backup access to the public switched telephone network (PSTN) via Basic Rate ISDN. This DIM is a plug-on module that connects to the NIM. For installation instructions, refer to [Installing Dial Backup and Network Interface Modules on page 49](#).

**Features and Specifications****Features**

- Clear Channel and bonding mode 1 call protocols
- Network support for 64 kbps (1 B-channel) or 128 kbps (2 B-channels)
- D-channel switch compatibility with AT&T 5ESS, Northern Telecom DMS-100, and National ISDN-1
- V.54 network loopback support

**Compliance**

- EMC - see [Electromagnetic Compatibility \(EMC\) Table on page 6](#).
- ACTA/FCC Part 68
- IC CS-03
- UL/CUL 60950-1

**Environmental**

- Operating Temperature: 0°C to 50°C
- Storage Temperature: -20°C to 70°C
- Relative Humidity: Up to 95 percent, noncondensing

**Physical**

- Dimensions: 2.5-inch W x 3.75-inch D

**NetVanta ISDN S/T DIM (P/N 1200875L1)**

The NetVanta ISDN S/T DIM provides dial backup access to the PSTN via Basic Rate ISDN. This DIM is a plug-on module that connects to the NIM. For installation instructions, refer to [Installing Dial Backup and Network Interface Modules on page 49](#).

**Features and Specifications****Features**

- Clear channel and bonding mode 1 call protocols
- Network support for 64 kbps (1 B-channel) or 128 kbps (2 B-channels)
- D-channel switch compatibility with AT&T 5ESS, Northern Telecom DMS-100, National ISDN-1, and Euro-ISDN
- V.54 network loopback support

**Compliance**

- EMC - see [Electromagnetic Compatibility \(EMC\) Table on page 6](#).
- ACIF S031
- ETSI TBR 3
- EN 60950-1
- IEC 60950-1
- AS/NZS 60950-1

**Environmental**

- Operating Temperature: 0°C to 50°C
- Storage Temperature: -20°C to 70°C
- Relative Humidity: Up to 95 percent, noncondensing

**Physical**

- Dimensions: 2.5-inch W x 3.75-inch D

## 4. UNIT INSTALLATION

The instructions and guidelines provided in this section cover hardware installation topics, such as wall mounting/rack mounting the unit and installing option cards. These instructions are presented as follows:

- [Mounting Options on page 44](#)
- [Supplying Power to the Unit on page 46](#)
- [Installing Dial Backup and Network Interface Modules on page 49](#)
- [Using a USB Cellular Modem with the NetVanta USB WWAN NIM on page 51](#)
- [Installing the NetVanta VPN Accelerator Card \(included in P/N 4200368L1\) on page 52](#)
- [Installing a SODIMM for Expandable Memory on page 53](#)
- [Installing a CompactFlash Card on page 55](#)

For information on router configuration for a specific application, refer to the configuration guides provided on the [ADTRAN Support Community](#). For details on the command line interface (CLI), refer to the [AOS Command Reference Guide](#). All other related documents are also available online at <http://supportforums.adtran.com>.

### **WARNING**

*To prevent electrical shock, do not install equipment in a wet location or during an electrical storm.*



*The NetVanta 4000 Series is intended to be installed, maintained, and serviced by qualified service personnel only and should be installed in a restricted access location as described in UL/IEC 60950-1.*



*Ethernet cables are intended for intrabuilding use only. Connecting an ADTRAN unit directly to Ethernet cables that run outside the building in which the unit is housed will void the user's warranty and could create a fire or shock hazard. To connect an ADTRAN unit to Ethernet cables that run outside the building, ADTRAN's Ethernet Port Protection Device (EPPD) (P/N 1700502G1) must be connected between the unit and the outside plant cable. Use of any Ethernet protector other than ADTRAN's for this purpose will void the user's warranty.*

## Tools Required

The following customer-provided tools are required for the hardware installation of the NetVanta 4300/4400 Series:

- Ethernet cable
- Network cable (module dependent)
- DSX-1 cable (T1/FT1 + DSX-1 module only)
- G.703 cable (E1/FE1 + G.703 module only)
- DBU cable (dial backup functions require an optional DIM)
- Phillips-head screwdriver (rack mounted applications only)



*To access the CLI of the NetVanta, you will also need a PC with VT-100 terminal emulation software and a console port cable. Instructions on how to access the CLI are available in the quick start guide shipped with your unit or online on the [ADTRAN Support Community](#).*

## Mounting Options

The NetVanta 4300/4400 Series can be installed in a tabletop, wallmount, or 19-inch rackmount configuration. The following sections provide step-by-step instructions for rack mounting and wall mounting.



*If you have purchased the VPN accelerator card for the NetVanta 4305, install it first. Refer to [Installing the NetVanta VPN Accelerator Card \(included in P/N 4200368L1\)](#) on page 52.*

## Rack Mounting NetVanta 4300/4400 Series

The NetVanta 4300/4400 Series units are housed in a 1U-high, rack-mountable chassis that can be installed into 19-inch equipment racks. Follow these steps to mount the NetVanta 4300/4400 Series in a rack:



- *If installed in a closed or multi-unit rack assembly, the operating ambient temperature of the rack environment may be greater than room ambient temperature. Therefore, consideration should be given to installing the equipment in an environment compatible with the maximum ambient temperature specified by the manufacturer.*
- *Installation of the equipment in a rack should be such that the amount of air flow required for safe operation of the equipment is not compromised.*
- *Be careful not to compromise the stability of the equipment mounting rack when installing this product.*
- *Consideration should be given to the connection of the equipment to the supply circuit and the effect that overloading the circuit might have on overcurrent protection and supply wiring. Appropriate consideration of equipment nameplate ratings should be used when addressing this concern.*
- *Reliable grounding of rack-mounted equipment should be maintained. Particular attention should be given to supply connections other than direct connections to the branch circuit (e.g., use of power strips).*

Instructions for Rack Mounting the NetVanta	
Step	Action
1	Position the NetVanta in a stationary equipment rack. This unit occupies 1U of space. To allow proper grounding, scrape the paint from the rack around the mounting holes where the NetVanta will be positioned.
2	Have an assistant hold the unit in position as you install two mounting bolts through the unit's brackets and into the equipment rack using a #2 Phillips-head screwdriver.
3	Proceed to the steps given in <a href="#">Supplying Power to the Unit on page 46</a> .

### Wall Mounting NetVanta 4300/4400 Series

By following these instructions exactly, the NetVanta can be safely mounted to the wall.

 <p><b>CAUTION</b></p>	<ul style="list-style-type: none"> <li>To avoid damaging the unit, use only the screws included in the shipment when attaching mounting ears to the chassis.</li> <li>When wall mounting the NetVanta, care must be taken not to damage the power cord. Do not attach the power cord to the building surface or run it through walls, ceilings, floors, or openings in the building structure.</li> <li>The socket-outlet must be installed near the equipment and must be easily accessible.</li> <li>When wall mounting the NetVanta 4430, do not remove the SFP slot covers unless an SFP has been installed in the slot.</li> </ul>
---	---

Instructions for Wall Mounting the NetVanta	
Step	Action
1	Remove the mounting ears from the NetVanta. Rotate them 90° so that the portion of the bracket with the mounting holes is flush with the bottom of the chassis. Reattach them to the chassis (see <a href="#">Figure 20 on page 46</a> ).
2	Decide on a location. All NetVanta 4000 Series units are mounted with the front panel facing up. Keep in mind that the unit needs to be mounted at or below eye level so that the LEDs are visible. <b>Important!</b> Mount the chassis with LEDs facing up (not facing sideways or down). <b>Important!</b> When wall mounting the NetVanta 4430, do not remove the SFP slot covers unless an SFP has been installed in the slot.
3	Prepare the mounting surface by attaching a board (typically plywood, 3/4-inch to 1-inch thick) to a wall stud using #6 to #10 (2.5-inch or greater in length) wood screws. <b>Important!</b> Mounting to a stud ensures stability. Using sheetrock anchors may not provide sufficient long-term stability.
4	Have an assistant hold the unit in position as you install two #6 to #10 wood screws through the unit's brackets and into the mounted board.
5	Proceed to the steps given in <a href="#">Supplying Power to the Unit on page 46</a> .

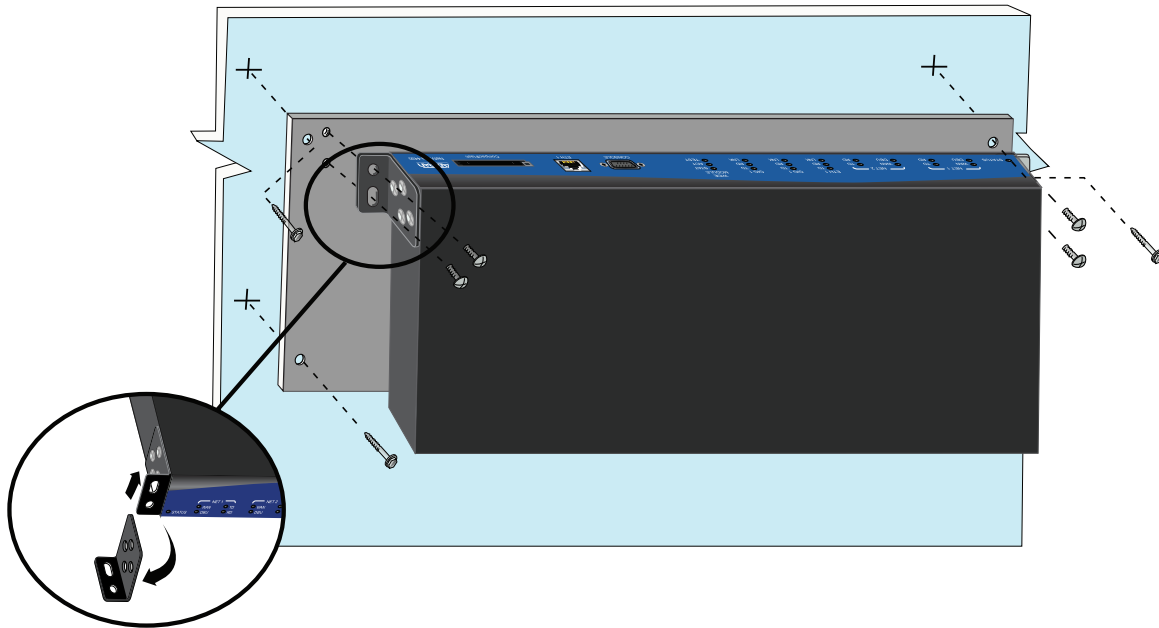

**Figure 20. Wall Mounting the Unit**

### Supplying Power to the Unit

As shipped, each NetVanta 4000 is set to factory default conditions. After installing the base unit and any option modules, the NetVanta 4000 is ready for power up. To power the unit, ensure that the unit is properly connected to an appropriate power source (as outlined in the sections below).

#### **NetVanta 4305 (AC) and NetVanta 4430**

The AC-powered NetVanta 4305 and NetVanta 4430 units come equipped with an auto-sensing 100 to 250 VAC, 50/60 Hz power supply. All appropriate power cords are included in the shipment of the units. To power these units, connect the power cable to an appropriately grounded power source.



- *Install unit in accordance with Article 400 and 364.8 of NEC NFPA 70.*
- *Maximum recommended ambient operating temperature is 50°C.*



*Previous versions of the NetVanta 4430 were equipped with either a 120 VAC, 50/60 Hz (1700630G1#120) or 240 VAC, 50/60 Hz (1700630G1#240) power supply. Plugging these units into an incompatible power source will damage the unit. Refer to the label on the unit before connecting the unit to the power source.*

### NetVanta 4305 (DC)

The DC-powered NetVanta 4305 connects to a centralized DC power source via the four-position power connector on the rear of the chassis (see *Figure 3 on page 15*). The nominal input of the NetVanta 4305 is +24 VDC or -48 VDC. Power and ground connections require copper conductors and a ring lug.

Instructions for Connecting DC Power Source to the NetVanta 4305	
Step	Action
1	With the power disconnected, connect the primary power source to input A of the power connector.
2	Connect a ground wire (fitted with a loop terminal end) to the grounding point using the screw provided. Connect the other end of the ground wire to a protective earth ground.
3	If using a backup power source, connect it to input B of the power connector.



- *Power to the NetVanta 4305 DC System must be from a reliably grounded 24 or 48 VDC.*
- *Use only copper conductors when making power connections.*
- *Install unit in accordance with the requirements of NEC NFPA 70.*
- *The branch circuit overcurrent protection shall be a fuse or circuit breaker rated minimum 48 VDC, maximum 10 A.*
- *A readily accessible disconnect device, that is suitably approved and rated, shall be incorporated in the field wiring.*
- *Maximum recommended ambient operating temperature is 50°C.*



*The 10/100Base-T and Gigabit Ethernet interfaces **MUST NOT** be metalically connected to interfaces that connect to the outside plant or its wiring. These interfaces are designed for use as intra-building interfaces only. The addition of primary protectors is not sufficient protection in order to connect this interface metalically to OSP wiring.*



*To comply with GR-1089-CORE, Issue 3, this equipment **MUST** only be installed in a DC-C (common) bonding and grounding environment. It may not be utilized in a DC-I (isolated) bonding and grounding environment.*

## Installing Dial Backup and Network Interface Modules

The DIMs plug onto the NIMs. The NIMs are then installed in the rear panel option module slot. The following tables list the installation steps. See [Figure 21 on page 49](#) below and [Figure 22 on page 50](#).

### WARNING

For NetVanta modules with outside plant connections, ensure that all cables are removed from all modules before installing or removing it from the NetVanta chassis.



Electronic modules can be damaged by static electrical discharge. Before handling modules, wear an antistatic discharge wrist strap to prevent damage to electrical components. Place modules in antistatic packing material when transporting or storing. When working on modules, always place them on an approved antistatic mat that is electrically grounded.

### Instructions for Installing the DIMs

Step	Action
1	Remove power from the unit.
2	If the NIM is already installed in the NetVanta chassis, remove all cables, release the pins at both edges of the NIM front panel, and slide the module out of the chassis.
3	Carefully align the P1 connector on the NIM with the J1 connector on the DIM. <i>Using only fingertip pressure</i> so that neither circuit board bends or flexes, ensure that the connectors are firmly seated. Secure the DIM to the NIM using the screws and standoff posts supplied. See <a href="#">Figure 21</a> .
4	Slide the NIM with the DIM attached into the NetVanta chassis, continuing with the normal NIM installation (refer to <a href="#">Instructions for Installing the NIMs and Wide NIMs on page 50</a> ).

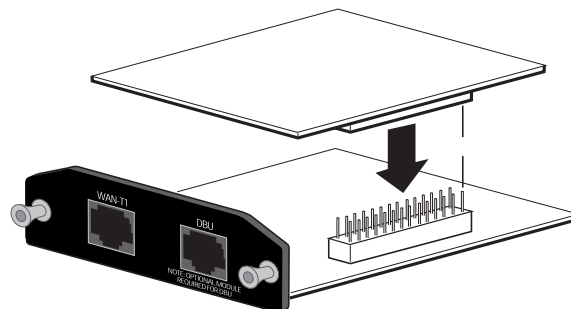

Figure 21. Installing DIMs



Instructions for Installing the NIMs and Wide NIMs	
Step	Action
1	Remove power from the unit.
2	Remove the cover plate from the appropriate option slot on the rear panel of the unit.
3	Slide the option module into the option slot until the module is firmly seated against the chassis.
4	Secure the pins at both edges of the module.
5	Connect the cables to the associated device(s).
6	Restore power to the unit.

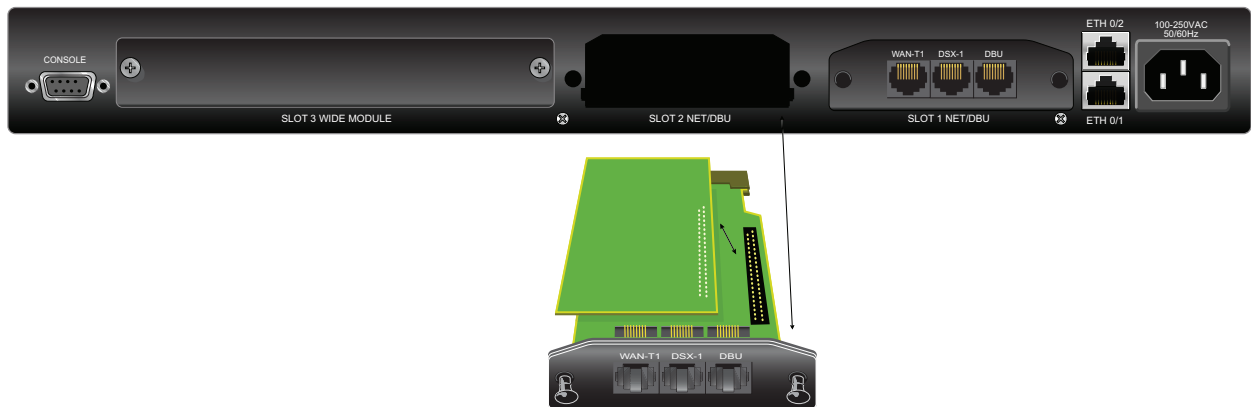

Figure 22. NIM and DIM Installation

## Using a USB Cellular Modem with the NetVanta USB WWAN NIM

The NetVanta USB WWAN NIM contains a Type A USB connector that supports a variety of third-party USB cellular modems.



Visit the NetVanta USB WWAN NIM product page at [www.adtran.com](http://www.adtran.com) for a list of supported third-party USB cellular modems.



- Always remove power from the unit prior to removing or installing a module.
- Improper installation may result in damage to the modules.

### Instructions for Installing a USB Cellular Modem in the USB WWAN NIM

Step	Action
1	Remove power from the base unit.
2	Remove the cover from the base unit's option slot.
3	Slide the USB WWAN NIM into the option slot until the module is firmly seated against the chassis.
4	Secure the pins at both edges of the module.
5	Restore power to the base unit.
6	Refer to the quick start guide that shipped with the NetVanta USB WWAN NIM for instructions on obtaining a cellular account and activating your USB cellular modem.



An optional USB Locking Mechanism is available from ADTRAN (P/N 1700643G1) to lock the USB to the NetVanta USB WWAN NIM.

### Installing the NetVanta VPN Accelerator Card (included in P/N 4200368L1)

The optional VPN Accelerator Card plugs into a 32-bit PCI slot and is designed to be used in the NetVanta 4305 to provide encryption/decryption and security acceleration services. The card provides the following security services to the host processor: DES, triple-DES (3DES), AES, SHA-1, MD5, and random number generation. Performance metrics include 528 Mbps (DES), 176 Mbps (3DES), and 422 Mbps (AES). The power consumption of the card does not exceed 2 watts.

**NOTE** *The AOS Enhanced Feature Pack software is required to take advantage of the VPN acceleration features of this card.*

**CAUTION** *The accelerator card is intended to be installed by qualified service personnel only.*

Instructions for Installing the VPN Accelerator Card	
Step	Action
1	Remove power from the unit.
2	Remove the screws holding the base unit and the cover together, and, if necessary, the two mounting brackets (see <a href="#">Figure 23</a> ).
3	Using a 3/16-inch hex driver, remove the two jack screws located on either side of the DB-9 port.
4	Carefully lift and remove the unit's cover to expose the circuit board.
5	Gently slide the accelerator card into the PCI slot as shown. The card is keyed to fit into the slot only one way. To avoid damaging the card pins, do not use excessive force.
6	Replace the unit cover, screws, and mounting brackets.
7	Restore power to the unit.

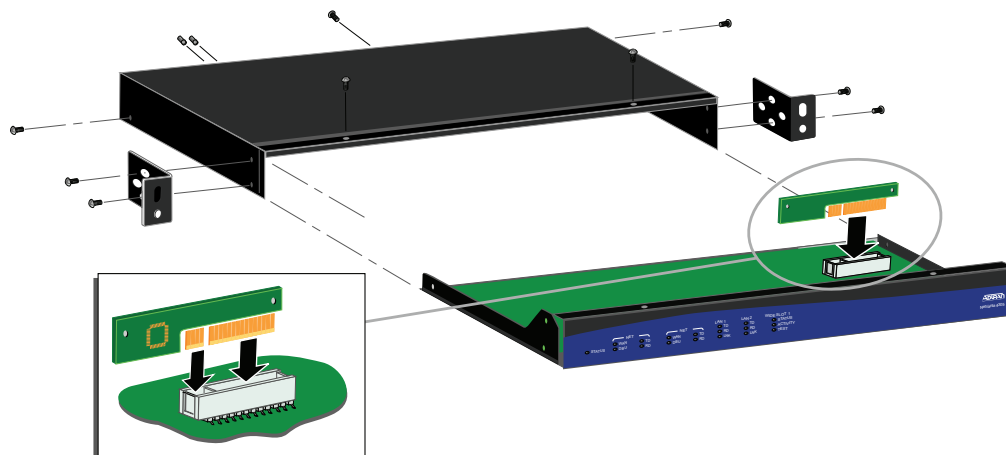

**Figure 23. NetVanta VPN Accelerator Card Installation**

## Installing a SODIMM for Expandable Memory

The NetVanta 4430 ships with a 200-pin, 256 MB SODIMM (P/N 1200813E1) installed. It can be upgraded to provide 512 MB using the 200-pin, 512 MB SODIMM (P/N 1200814E1). Follow these instructions to install a SODIMM module.



- *SODIMMs are intended to be installed only by qualified service personnel.*
- *There are three types of SODIMM memory modules used by ADTRAN: 200-pin DDR1, 200-pin DDR2, and 144-pin DDR2. Although these modules look very similar, they are not interchangeable. Prior to beginning the upgrade process, make sure you have purchased the correct upgrade module for your ADTRAN product.*
- *Before touching electronic components, make sure you are properly grounded. By wearing a wrist strap (or using some other type of static control device), you can prevent static electricity stored on your body or clothing from damaging your installation.*

Instructions for Installing a SODIMM	
Step	Action
1	Remove power from the unit.
2	Remove the screws holding the base unit and the cover together, and, if necessary, the two mounting brackets.
3	Using a 3/16-inch hex driver, remove the two jack screws located on either side of the DB-9 port.
4	Carefully lift and remove the unit's cover to expose the circuit board.
5	Once you have discharged your static electricity, pick up the SODIMM by its top or sides. Do not touch the gold contacts at the bottom.
6	Gently insert the module into the memory slot at a slight angle (approximately 30 degrees) as shown in <a href="#">Figure 24 on page 54</a> . Note that the socket and module are both keyed, which means the module can be installed one way only.
7	To avoid damage, do not use excessive force. To seat the module into the socket, apply firm, even pressure to each end of the module (see the arrows in <a href="#">Figure 25 on page 54</a> ) until you feel it slip down into the socket. If you are having problems getting the module to seat properly, try rocking the module up and down slightly, while continuing to apply pressure. When properly seated, the contact fingers on the edge of the module will almost completely disappear inside the socket.
8	With the module properly seated in the socket, rotate the module downward, as indicated in <a href="#">Figure 26 on page 54</a> . Continue pressing downward until the clips at each end of the socket lock into position. With most sockets, you will hear a distinctive CLICK, indicating the module is correctly locked into position.
9	Replace the unit cover, screws, and mounting brackets.
10	Restore power to the unit.

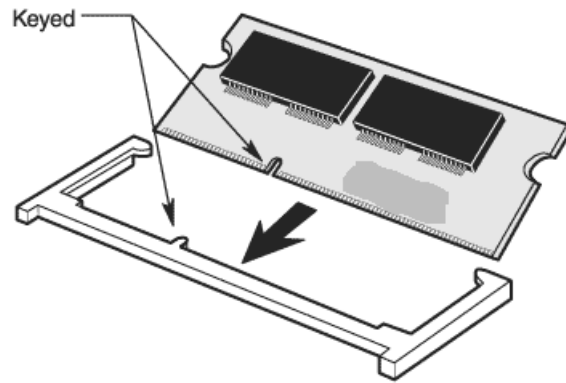

**Figure 24. SODIMM Installation – Keyed Slots**

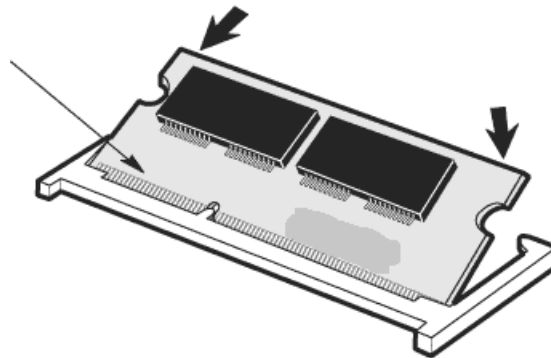

**Figure 25. SODIMM Installation – Applying Pressure**

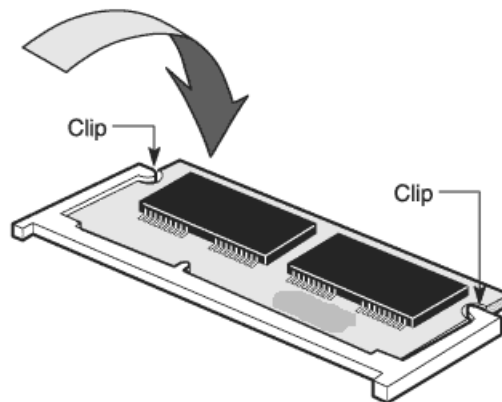

**Figure 26. SODIMM Installation – Rotating the Module Downward**

## Installing a CompactFlash Card

The **CompactFlash** slot supports any industry standard 1 GB CompactFlash card. Follow these instructions when installing a card.



*The CompactFlash card is hot-swappable and can be inserted or removed while power is applied to the unit.*

### Instructions for Installing a CompactFlash Card

Step	Action
1	Slide the module into the CompactFlash slot until the card is firmly seated against the chassis.
2	The CompactFlash options will now be available in the GUI and the AOS CLI.

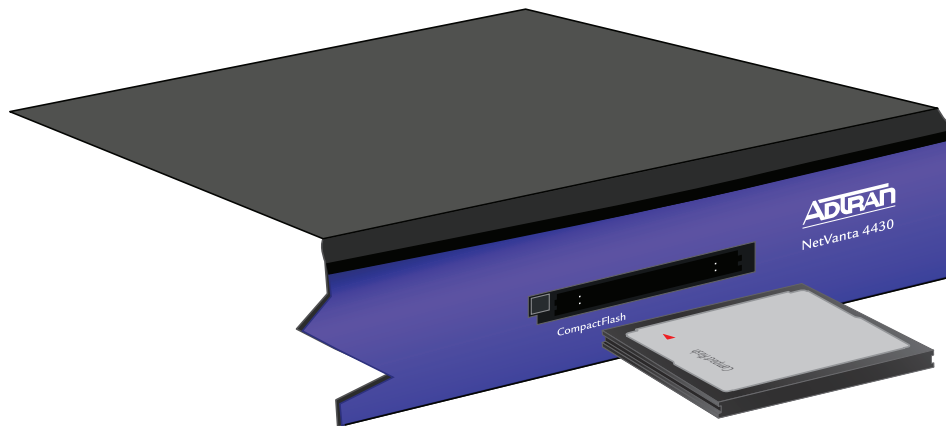

**Figure 27. CompactFlash Card Installation**

Your NetVanta unit is now ready to be configured and connected to the network. For information on configuration for a specific application, refer to the configuration guides provided on the [ADTRAN Support Community](#). For details on the command line interface (CLI), refer to the *AOS Command Reference Guide*. All other related documents are also available online at <http://supportforums.adtran.com>.



## APPENDIX A. CONNECTOR PIN DEFINITIONS

The following tables provide the pin assignments for the base unit, network interface modules (NIMs), and dial backup interface modules (DIMs).

### Base Unit Pinouts

**Table A-1. 10/100Base-T Ethernet Port Pinouts**

Pin	Name	Description
1	TX1	Transmit Positive
2	TX2	Transmit Negative
3	RX1	Receive Positive
4, 5	—	Unused
6	RX2	Receive Negative
7, 8	—	Unused

**Table A-2. 1000Base-T Gigabit Ethernet Port Pinouts**

Pin	Name	Description
1	TRD0+	Transmit/Receive Positive
2	TRD0-	Transmit/Receive Negative
3	TRD1+	Transmit/Receive Positive
4	TRD2+	Transmit/Receive Positive
5	TRD2-	Transmit/Receive Negative
6	TRD1-	Transmit/Receive Negative
7	TRD3+	Transmit/Receive Positive
8	TRD3-	Transmit/Receive Negative



**Table A-3. SFP Slot Pinouts**

Pin	Name	Pin	Name
1	TGND	11	RGND
2	TX FAULT	12	RX-
3	TX DISABLE	13	RX+
4	MOD DEF(2)	14	RGND
5	MOD DEF(1)	15	VccR
6	MOD DEF(0)	16	VccT
7	RATE SELECT	17	TGND
8	LOS	18	TX+
9	RGND	19	TX-
10	RGND	20	TGND

**Table A-4. CONSOLE Port (DCE) Pinouts**

Pin	Name	Description
1	DCD	Data Carrier Detect (output)
2	RD	Receive Data (output)
3	TD	Transmit Data (input)
4	DTR	Data Terminal Ready (input)
5	SG	Signal Ground
6	DSR	Data Set Ready (output) - <b>Tied to pin 1</b>
7	—	Unused
8	CTS	Clear to Send (output) - <b>Tied to pin 1</b>
9	—	Unused



*Connection directly to an external modem requires a cross-over cable.*

## Network Interface Module Pinouts

**Table A-5. WAN-DDS Connector Pinouts**

Pin	Name	Description
1	R1	Transmit data to the network—Ring 1
2	T1	Transmit data to the network—Tip 1
3-6	—	Unused
7	T	Receive data from the network—Tip
8	R	Receive data from the network—Ring

**Table A-6. WAN-T1 Connector Pinouts**

Pin	Name	Description
1	R1	Receive data from the network—Ring 1
2	T1	Receive data from the network—Tip 1
3	—	Unused
4	R	Transmit data toward the network—Ring
5	T	Transmit data toward the network—Tip
6-8	—	Unused

**Table A-7. WAN-E1 Connector Pinouts**

Pin	Name	Description
1	R1	Receive data from the network—Ring 1
2	T1	Receive data from the network—Tip 1
3	—	Unused
4	R	Transmit data toward the network—Ring
5	T	Transmit data toward the network—Tip
6-8	—	Unused

**Table A-8. DSX-1 Connector Pinouts**

Pin	Name	Description
1	R	Transmit data toward the DTE–Ring
2	T	Transmit data toward the DTE–Tip
3	—	Unused
4	R1	Receive data from the DTE–Ring 1
5	T1	Receive data from the DTE–Tip 1
6-8	—	Unused

**Table A-9. G.703 Connector Pinouts**

Pin	Name	Description
1	R	Transmit data toward the DTE–Ring
2	T	Transmit data toward the DTE–Tip
3	—	Unused
4	R1	Receive data from the DTE–Ring 1
5	T1	Receive data from the DTE–Tip 1
6-8	—	Unused

**Table A-10. WAN-ADSL NIM Connector Pinouts**

Pin	Name	Description
1, 2	—	Unused
3	R	ADSL Ring
4	T	ADSL Tip
5, 6	—	Unused

**Table A-11. WAN-SHDSL Connector Pinouts**

Pin	Name	Description
1	T2	Loop 2–Tip
2	R2	Loop 2–Ring
3	—	Unused
4	T1	Loop 1–Tip
5	R1	Loop 1–Ring
6-8	—	Unused

**Table A-12. USB WWAN Connector Pinouts**

Pin	Name	Description
1	Vbus	Provides 5 VDC power up to 1000 mA
2	D-	Data
3	D+	Data
4	Ground	Ground

**Table A-13. Serial to Cable Pinouts**

Serial Pin	V.35 Pin	X.21 Pin	EIA 530 Pin	Name
1	P	2	2	TD_A
2	U	N/A	24	ETC_A
3	Y	N/A	15	TCLK_A
4	V	6	17	RCLK_A
5	R	4	3	RD_A
6	F	N/A	8	DCD_A
7	H	N/A	20	DTR_A
8	C	3	4	RTS_A
9	N/A	10	19	RTS_B (V.11 only)
10	N/A	12	13	CTS_B (V.11 only)
11	D	5	5	CTS_A
12	E	N/A	6	DSR_A
13	K	N/A	25	TM_A
14	S	9	14	TD_B
15	W	N/A	11	ETC_B
16	AA	N/A	12	TCLK_B
17	X	13	9	RCLK_B
18	T	11	16	RD_B
19-25	N/A	N/A	N/A	Unused
26	B	8	7	Ground

## Dial Backup Interface Module Pinouts (DBU Connector)



*An optional DIM is required for dial backup applications.*

**Table A-14. Analog Modem and ISDN BRI DBU Connector Pinouts**

Pin	Name	Description
1-3	—	Unused
4	R	Network–Ring
5	T	Network–Tip
6-8	—	Unused

**Table A-15. ISDN S/T DBU Connector Pinouts**

Pin	Name	Description
1, 2	—	Unused
3	R1	Network Receive–Ring 1
4	R	Network Transmit–Ring
5	T	Network Transmit–Tip
6	T1	Network Transmit–Tip 1
7, 8	—	Unused